

All rights reserved. No part of this publication may be reproduced, stored in a retrieval system, or transmitted in any form or by any means, electronic, mechanical, photocopying, recording, or otherwise, without the prior written permission of SEIKO EPSON CORPORATION. The information contained herein is designed only for use with this EPSON printer. EPSON is not responsible for any use of this information as applied to other printers.

Neither SEIKO EPSON CORPORATION nor its affiliates shall be liable to the purchaser of this product or third parties for damages, losses, costs, or expenses incurred by the purchaser or third parties as a result of: accident, misuse, or abuse of this product or unauthorized modifications, repairs, or alterations to this product, or (excluding the U.S.) failure to strictly comply with SEIKO EPSON CORPORATION's operating and maintenance instructions.

SEIKO EPSON CORPORATION shall not be liable for any damages or problems arising from the use of any options or any consumable products other than those designated as Original EPSON Products or EPSON Approved Products by SEIKO EPSON CORPORATION.

SEIKO EPSON CORPORATION shall not be held liable for any damage resulting from electromagnetic interference that occurs from the use of any interface cables other than those designated as EPSON Approved Products by SEIKO EPSON CORPORATION.

EPSON is a registered trademark and EPSON Stylus is a trademark of SEIKO EPSON CORPORATION.

PRINT Image Matching is a term for the print command that is embedded in header file of the image created by digital camera. It contains color setting and image parameter information. SEIKO EPSON CORPORATION holds the copyright for PRINT Image Matching Version 1.0.

Microsoft and Windows are registered trademarks of Microsoft Corporation.

*General Notice: Other product names used herein are for identification purposes only and may be trademarks of their respective owners. EPSON disclaims any and all rights in those marks.*

Copyright © 2000 by SEIKO EPSON CORPORATION, Nagano, Japan.



Printed on Recycled Paper.

---

# Contents

<b>Safety Instructions</b> .....	7
Important Safety Instructions .....	1
Information for United Kingdom Users .....	5
Warnings, Cautions, and Notes .....	6
<b>Setup Guide</b> .....	7
Checking the Package Contents .....	7
Unpacking the Printer .....	8
Attaching the Printer Parts .....	8
Plugging In and Connecting the Printer .....	10
Installing the Printer Software .....	12
Installing the Ink Cartridges .....	18
Installing the Photo Print Software .....	25
<b>Printer Parts and Control Panel Functions</b> .....	29
Printer Parts .....	29
Buttons .....	30
Lights .....	31
<b>Loading Paper</b> .....	32
Loading Special Paper and Other Media .....	32
Loading Envelopes .....	35
<b>Using Roll Paper</b> .....	37
Using the Roll Paper Holder .....	37
Removing the Roll Paper from the Printer .....	41
<b>Printing with PRINT Image Matching</b> .....	43
How is PRINT Image Matching used? .....	43
<b>Printing with Windows</b> .....	46

Printer Software Introduction .....	46
Making Settings on the Main Menu .....	47
Making Settings on the Paper Menu .....	48
Making Settings on the Layout Menu .....	49
<i>Printing with Macintosh</i> .....	50
Printer Software Introduction .....	50
Making settings in the Print dialog box .....	51
Making settings in the Page Setup dialog box .....	52
Making settings in the Layout dialog box .....	53
<i>Replacing Ink Cartridges</i> .....	54
Using the Printer's Control Panel .....	54
<i>Troubleshooting</i> .....	59
Error Indicators .....	61
Maintenance .....	63
Correcting USB Problems .....	65
<b>Consumable Products</b> .....	71
<b>Customer Support</b> .....	75
Technical Support Web Site .....	75
Regional Customer Services .....	75
<b>System Requirements</b> .....	77
Using the online Reference Guide .....	77

---

# *Safety Instructions*

---

## *Important Safety Instructions*

Read all of the instructions in this section before using your printer. Also, be sure to follow all warnings and instructions marked on the printer.

### *When setting up your printer*

Observe the following when setting up the printer:

- Do not block or cover the openings in the printer's cabinet.
- Use only the type of power source indicated on the printer's label.
- Connect all equipment to properly grounded power outlets. Avoid using outlets on the same circuit as photocopiers or air control systems that regularly switch on and off.
- Avoid electrical outlets controlled by wall switches or automatic timers.
- Keep the entire computer system away from potential sources of electromagnetic interference, such as loudspeakers or the base units of cordless telephones.
- Do not use a damaged or frayed power cord.
- If you use an extension cord with the printer, make sure that the total ampere rating of the devices plugged into the extension cord does not exceed the cord's ampere rating. Also, make sure that the total ampere rating of all devices plugged into the wall outlet does not exceed the wall outlet's ampere rating.

- ❑ Do not attempt to service the printer yourself.
- ❑ Unplug the printer and refer servicing to qualified service personnel under the following conditions:

The power cord or plug is damaged; liquid has entered the printer; the printer has been dropped or the cabinet damaged; the printer does not operate normally or exhibits a distinct change in performance.

- ❑ If you plan to use the printer in Germany, the building installation must be protected by a 10 or 16 amp circuit breaker to provide adequate short-circuit protection and over-current protection for this printer.



## *When choosing a place for the printer*

Observe the following when choosing a place for the printer:

- ❑ Place the printer on a flat, stable surface that extends beyond the printer base in all directions. The printer will not operate properly if it is tilted or at an angle.
- ❑ Leave enough space in front of the printer for the paper to be fully ejected.
- ❑ Avoid places subject to rapid changes in temperature and humidity. Also, keep the printer away from direct sunlight, strong light, or heat sources.
- ❑ Avoid places subject to dust, shocks, and vibrations.
- ❑ Leave enough room around the printer to allow for sufficient ventilation.
- ❑ Place the printer near a wall outlet where the plug can be easily unplugged.

## ***When using the printer***

Observe the following when using the printer:

- ❑ Do not insert objects through the slots in the printer's cabinet.
- ❑ Take care not to spill liquid on the printer.
- ❑ Do not put your hand inside the printer or touch the ink cartridges during printing.
- ❑ Do not move the print head by hand; otherwise, you may damage the printer.
- ❑ Always turn the printer off using the  power button. When this button is pressed, the  power light flashes briefly and then goes out. Do not unplug the printer or turn off the power to the outlet until the  power light stops flashing.
- ❑ Before transporting the printer, make sure that the print head is in the home (far right) position and the ink cartridges are in place.

## ***When handling the ink cartridges***

Observe the following when handling the ink cartridges:

- ❑ Keep ink cartridges out of the reach of children. Do not allow children to drink from or otherwise handle the cartridges.
- ❑ Be careful when you handle the used ink cartridges, as there may be some ink remaining around the ink supply port. If ink gets on your skin, wash the area thoroughly with soap and water. If discomfort or vision problems remain after a thorough flushing, see a doctor immediately.
- ❑ Do not shake an ink cartridge; this can cause leakage.

- ❑ Install the ink cartridge immediately after you remove it from its package. Leaving the cartridge unpacked for a long time before use may result in reduced print quality.
- ❑ Do not use an ink cartridge beyond the date printed on the cartridge carton. For best results, use up the ink cartridges within six months of installing them.
- ❑ Do not dismantle the ink cartridges or try to refill them. This could damage the print head.
- ❑ After bringing an ink cartridge inside from a cold storage site, allow it to warm up at room temperature for at least three hours before using it.
- ❑ Store ink cartridges in a cool, dark place.
- ❑ Do not touch the green IC chip on the side of the cartridge. This may affect normal operation and printing.
- ❑ The IC chip on this ink cartridge retains a variety of cartridge related-information, such as the amount of ink remaining, so that a cartridge may be removed and reinserted freely. However, each time the cartridge is inserted, some ink is consumed because the printer automatically performs a reliability check.
- ❑ If you remove an ink cartridge for later use, protect the ink supply area from dirt and dust and store it in the same environment as the printer. A valve in the ink supply port makes covers or plugs unnecessary, but the ink may stain items that come in contact with this area of the cartridge. Do not touch the ink supply port or surrounding area.

## ENERGY STAR® Compliance



As an ENERGY STAR® Partner, EPSON has determined that this product meets the ENERGY STAR® guidelines for energy efficiency.

The International ENERGY STAR® Office Equipment Program is a voluntary partnership with the computer and office equipment industry to promote the introduction of energy-efficient personal computers, monitors, printers, fax machines, copiers, and scanners in an effort to reduce air pollution caused by power generation.

---

## Information for United Kingdom Users

### Use of options

EPSON (UK) Limited shall not be liable against any damages or problems arising from the use of any options or consumable products other than those designated as Original EPSON Products or EPSON Approved Products by EPSON (UK) Limited.

### Safety information



**Warning:**

*This appliance must be earthed. Refer to the rating plate for the voltage and check that the appliance voltage corresponds to the supply voltage.*

**Important:** *The wires in the mains lead fitted to this appliance are coloured in accordance with the following code:*

*Green and yellow – Earth*

*Blue – Neutral*

*Brown – Live*



**If you have to fit a plug:**

As the colours of the mains lead of this appliance may not match the coloured markings used to identify the terminals in a plug, please observe the following:

- ❑ The green and yellow wire must be connected to the terminal in the plug which is marked with the letter E or the earth symbol ( $\perp$ ).
- ❑ The blue wire must be connected to the terminal in the plug marked with the letter N.
- ❑ The brown wire must be connected to the terminal in the plug marked with the letter L.
- ❑ If the plug is damaged, replace the cord set or consult a qualified electrician.
- ❑ Replace fuses only with fuses of the correct size and rating.

---

## ***Warnings, Cautions, and Notes***



*Warnings must be followed carefully to avoid bodily injury.*



*Cautions must be observed to avoid damage to your equipment.*

*Notes contain important information and useful tips on the operation of your printer.*

---

# Setup Guide

---

## Checking the Package Contents

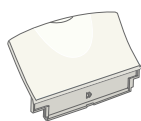

**paper support**



**paper manuals**

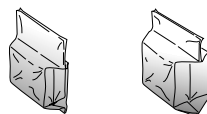

**black  
ink cartridges**      **color  
ink cartridges**

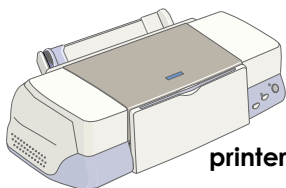

**printer**

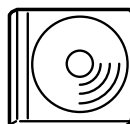

**printer software &  
Reference Guide CD-ROM**

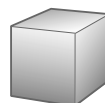

**roll paper**

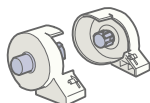

**roll paper holder**

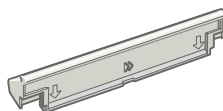

**paper support adapter**

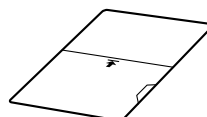

**protective film**

The package contents may vary in certain locations.

The illustration in this Guide show the EPSON Stylus Photo 1290; the EPSON Stylus Photo 890 is a smaller version of the printer.

---

## Unpacking the Printer

Remove all tape and protective materials from the printer.

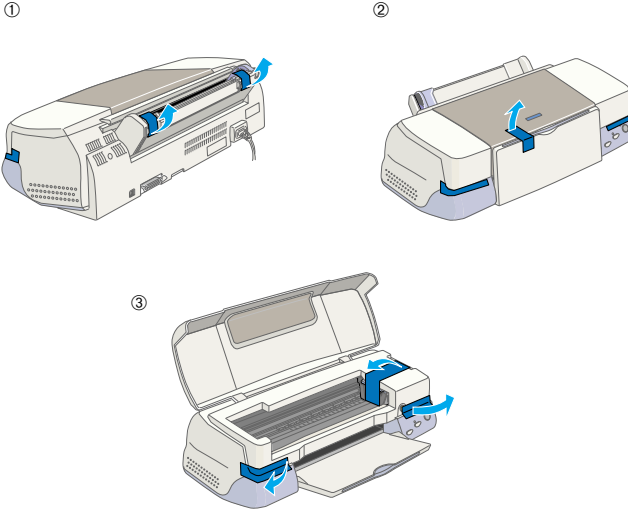

---

## Attaching the Printer Parts

Hold the paper support adapter so that the arrows on the adapter are toward the front of the printer, and insert the adapter into the slot at the rear of the printer.

Insert the roll paper holder into the slots at the back of the paper support adapter, then insert the paper support into the slot at the rear of the paper support adapter.

**Note:**

At this time you may mount the roll paper holder temporarily, by inserting it into any slots at the rear of the paper support adapter. You do not need to actually mount the roll paper.

①

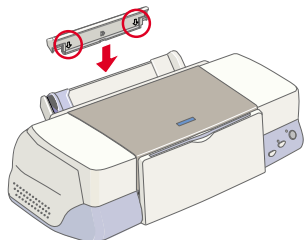

②

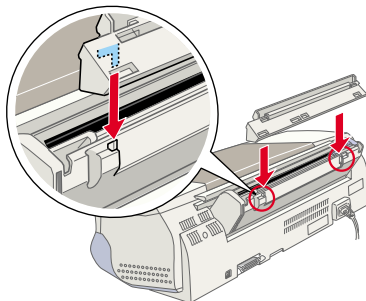

③

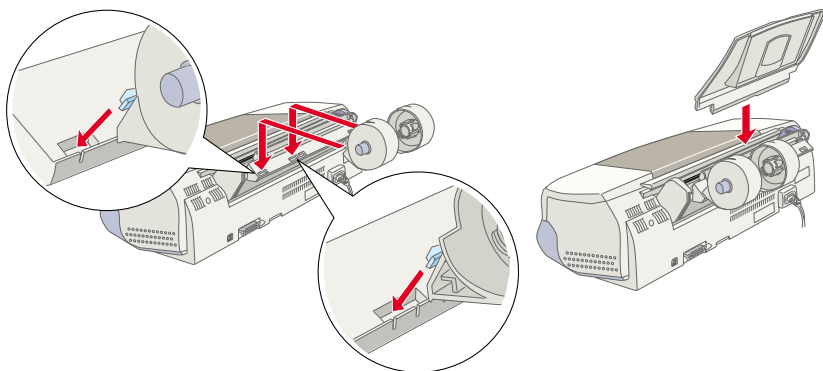

---

## Plugging In and **Connecting the Printer**

Your printer connects to your computer via the parallel or USB interface. Macintosh computers can only be connected via the USB interface. Depending upon your geographic location, you may need to obtain the appropriate cable. See “Options and Consumable Products” in the *Daily Use* guide for details.

### **Note:**

*In order to connect your PC via the USB interface, your computer must be a Windows Me, 98 or Windows 2000 pre-installed model that comes with a USB port or Windows Me upgraded from a Windows 98 pre-installed model.*

## Using a **parallel interface for Windows users**

To connect the printer to your PC, you need a shielded, twisted-pair parallel cable. Follow the directions below.

1. Make sure that both the printer and the computer are turned off. Plug the power cord into a properly grounded electrical outlet.
2. Plug the cable connector securely into the printer's interface connector. Then, squeeze the wire clips together until they lock in place on both sides. If your printer has a ground connector screw to the right of the interface connector, connect the ground wire to the ground connector screw.

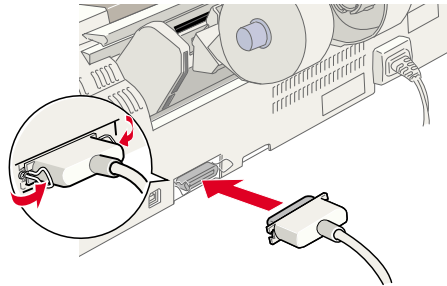

3. Plug the other end of the cable into the computer's parallel interface. If there is a ground wire at the computer end of the cable, connect it to the ground connector at the back of the computer.

## Using a **USB interface** for **Windows and Macintosh users**

To connect the printer to a USB port, you need a standard, shielded USB cable. Follow these steps.

### *Note:*

- ❑ *For best results, you should connect the printer directly to the computer's USB port. If you must use multiple USB hubs, we recommend that you connect the printer to the first tier hub.*
- ❑ *If your computer has more than one USB port, you may plug the cable in wherever is convenient.*

1. Make sure that both the printer and the computer are turned off. Plug the power cord into a properly grounded electrical outlet.
2. Plug the appropriate end of the cable into the USB port on the back of the printer. (The end that fits the printer has a different shape from the end that fits the computer.)
3. Connect the other end of the cable to the computer's USB port.

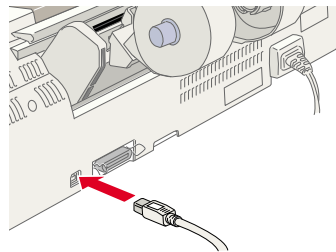

---

## Installing the Printer Software

After connecting the printer to your computer, you need to install the software included on the “Printer Software for EPSON Stylus Photo 1290” or “Printer Software for EPSON Stylus Photo 890” CD-ROM shipped with your printer.

The printer software CD-ROM contains:

- ❑ **Printer software (printer driver and utilities)**  
The printer driver runs, or “drives,” your printer; use it to make settings such as print quality, speed, media type, and paper size. The Nozzle Check, Head Cleaning, and Print Head Alignment utilities help you keep your printer in top operating condition. EPSON Status Monitor 3 (for Windows) or EPSON StatusMonitor (for Macintosh) notifies you of printer errors and displays printer status information such as the amount of ink remaining. The Status Monitor also guides you through the ink cartridge replacement process.
  
- ❑ **Online guides**  
The online *Reference Guide* helps you learn more about your printer.

If you wish to make a floppy disk version of the printer software on your CD-ROM, you can use the driver disk creation utility included on the CD.

Refer to the appropriate section.

## For Windows

Follow the instructions in this section to install the printer software.

### Installing the printer software

1. Make sure that your printer is turned off.
2. Turn on your computer and start Windows. If the New Hardware Found dialog box or any other Wizard appears, click Cancel.
3. Insert the printer software CD shipped with your printer in the CD-ROM drive. The Installer dialog box appears. If it does not, double-click the My Computer icon, click the CD-ROM icon, then click Open on the File menu. Then, double-click EPsetup.exe. (For floppy disk users, insert the disk in a disk drive and double-click the My Computer icon, then the floppy disk drive icon, and then Setup.exe.)
4. Select Install Printer Driver/Utility, and click . Then, click OK in the dialog box that appears to start the printer software installation. If Problem Solver is available in your location, it is automatically installed on your hard drive.

#### Note:

- ❑ *It is possible to install the Reference Guide on your hard drive from the Installer dialog box, as shown on the right. To install the guide, click Online Guide and then . Then, click Install Reference Guide and follow the on-screen instructions. When the installation is complete, an ESP 1290 890 Guide icon appears in the EPSON folder. Double-click the icon to open the guide.*





- *The Problem Solver provides tips and instructions to help you solve most problems that you may encounter when printing. The Problem Solver can be accessed through the EPSON folder, Status Monitor 3, or the printer software. For details, see the "Troubleshooting" section of your Daily Use guide.*

5. Follow the on-screen instructions to turn on your printer.

For Windows Me and 98 users, the printer port configuration starts automatically.

For printers connected via the USB cable, the USB device driver installation starts automatically at this point. When a message appears asking you to restart your computer, do so.

If you are a Windows 2000 user and using a parallel cable, click the Stop Search button when the USB device driver installation starts, then follow the on-screen instructions.

6. After turning on the printer, the Setup utility opens automatically. Follow the on-screen instructions to install the ink cartridges, check the print head nozzles, and clean the print head. When a message appears informing you that the setup is complete, click OK.



**Note:**

*If the Setup utility does not start, proceed to "Installing the Ink Cartridges" to install the ink cartridges using the printer's control panel.*

7. When a message appears informing you that the installation is complete, click OK.

**Note:**

*If an error message appears, either the printer software or the EPSON USB printer device driver is not installed correctly. See "Troubleshooting" in the Daily Use guide for details.*

## **For Macintosh**

Follow the instructions in this section to install the printer software, and select your printer in the Chooser.



**Caution:**

*Turn off all virus protection programs before you install the printer software.*

### **Installing the printer software**

Follow these steps to install your printer software.

1. Turn on your Macintosh and insert the software CD in the CD-ROM drive. The EPSON printer software CD-ROM opens automatically.
2. If the Install Printer Driver/Utility folder appears in the EPSON folder, open it and then double-click the Installer icon.

### Note:

- ❑ *It is possible to install the Reference Guide on your hard drive from the printer software CD-ROM. To install the guide, click Install Reference Guide and follow the on-screen instructions. When the installation is complete, a View Reference Guide icon appears in the EPSON folder. Double-click the icon to open the guide.*
  
- ❑ *It is possible to access Technical Support from the printer software CD-ROM. Insert the CD in the CD-ROM drive and open the Install Printer Driver/Utility folder in the EPSON folder. Then double-click the Technical Support Web Site icon.*

3. At the initial screen, click Continue. The Installer dialog box appears.

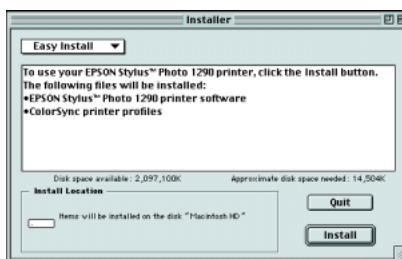

4. To install the printer software that is included on your printer software CD-ROM, make sure that the Install Location box displays the correct drive, then click Install.

5. When a message appears informing you that the installation is complete, click Restart to restart your computer.

## Selecting your printer in the Chooser

After you have installed the printer software on your Macintosh, you need to open the Chooser and select your printer. You must select a printer the first time you use it or whenever you want to switch to another printer. Your Macintosh will always print using the last printer selected. Follow the steps below to select your printer in the Chooser.

1. Choose Chooser from the Apple menu. Then, select the icon for your printer and the port that your printer is connected to.

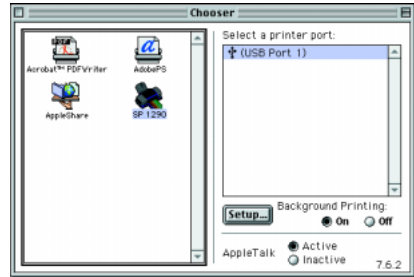

2. Select the appropriate Background Printing radio button to turn background printing on or off.

When background printing is on, you can use your Macintosh while it is preparing a document for printing. In order to use the EPSON Monitor3 utility to manage print jobs, background printing must be turned on.

3. Close the Chooser.

---

## ***Installing the Ink Cartridges***

This printer uses ink cartridges equipped with IC chips. The IC chip accurately monitors the amount of ink used by each cartridge, so even if a cartridge is removed and inserted again, all of its ink can be used. However, some ink from both color and black ink cartridges is consumed each time a cartridge is inserted because the printer automatically checks reliability.

Be sure to use the ink cartridges packed with your printer the first time that you install ink cartridges.

Refer to the appropriate section.

## ***Using the Setup utility for Windows users***

The Setup utility should open automatically when your printer software installation is complete. Follow the on-screen instructions. If you cannot access the Setup utility, refer to the next section, "Using the printer's control panel".

## ***Using the printer's control panel***

If you are a Macintosh user or cannot access the Setup utility, use the printer's control panel to install the ink cartridges.

Before installing the ink cartridges, note the following.



***Warning:***

*The ink cartridges are self-contained units. Under ordinary use, ink will not leak from a cartridge. If ink does get on your hands, wash them thoroughly with soap and water. If ink gets into your eyes, flush them immediately with water.*

**Note:**

*Do not open the ink cartridge packages until just before you install them; otherwise, the ink may dry up.*

Follow the steps below to install the ink cartridges.

1. Lower the output tray and open the printer cover.

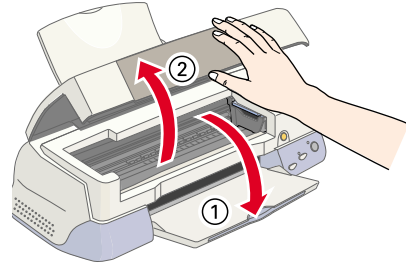

2. Turn on the printer by pressing the  power button.

The print head moves to the left, which is the ink cartridge installation position. The  power light flashes and the error light comes on.

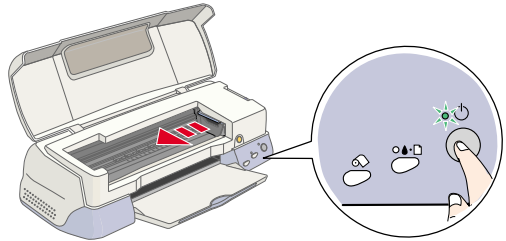

**Caution:**

*Do not move the print head by hand. Doing so may damage the printer.*

3. Push back the release tabs and lift up the ink cartridge clamps.

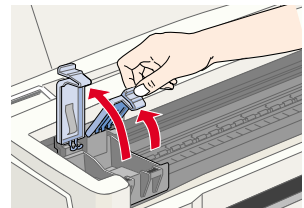

4. Open the ink cartridge packages. Next, remove only the yellow tape seals from each cartridge.

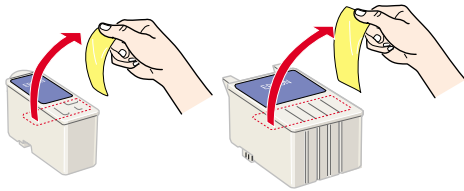

**Caution:**

- ❑ *You must remove the yellow tape seals from the cartridges before installing them; otherwise, the cartridges will become unusable and you will be unable to print.*
- ❑ *If you have installed an ink cartridge without removing the yellow tape seal, you must remove the cartridge and install a new one. Prepare the new cartridge by removing the yellow tape seal, then install it in the printer.*
- ❑ *Do not remove the blue portion of the tape seal from the cartridges; otherwise, the cartridges may become unusable.*
- ❑ *Do not remove the tape seals from the bottom of the cartridges; otherwise, ink will leak.*
- ❑ *Do not touch the green IC chip on the side of the cartridge. Doing so may prevent normal operation and printing.*
- ❑ *Do not remove the green IC chip from the side of the cartridge. If you install an ink cartridge without a chip, the printer may be damaged.*

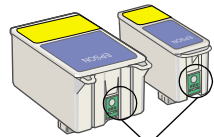

Do not touch this part.

- Align the tabs on each ink cartridge so that they are resting on the tabs protruding from the base of the opened ink cartridge clamps. Do not apply excessive force to the cartridges.

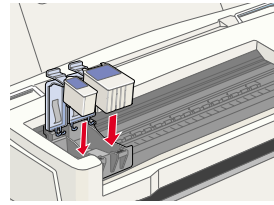

**Caution:**

*Make sure that the ink cartridge tabs are not under the tabs protruding from the base of the opened ink cartridge clamps, as this can damage the clamps.*



**Note:**

*Install both ink cartridges. If either of the cartridges is not installed, the printer will not work.*



- Lower the ink cartridge clamps until they lock into place.
- Press the  ink cartridge replacement button. The printer moves the print head and begins charging the ink delivery system. This process takes about two and a half minutes.

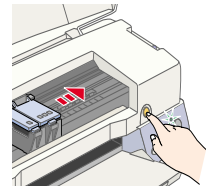

**Caution:**

*Always press the  ink cartridge replacement button to move the print head. Do not move the print head by hand. Doing so may damage the printer.*



While the ink is charging, the  power light flashes and the printer produces a variety of mechanical sounds. These sounds are normal. When the ink delivery system has been charged, the print head returns to the home (far right) position and the  power light comes on.





**Caution:**

*Never turn off the printer while the  power light is flashing.*

8. Close the printer cover.

## Checking the printer

Before printing your first page, you need to make sure that the printer is working correctly by loading paper, then printing a nozzle check page and, if necessary, cleaning the print head. Refer to the section below.

### Loading paper

Follow the steps below to load plain paper in the printer.

1. Lower the output tray and slide out the extension. Next, slide the left edge guide so that the distance between the edge guides is slightly wider than the width of your paper.
2. Fan a stack of paper, then tap it on a flat surface to even the edges.
3. Load the stack of paper in the sheet feeder with the printable side up and the right edge of the paper resting against the right edge guide. Then, slide the left edge guide against the left edge of the paper.

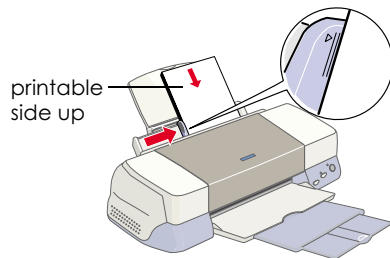

**Note:**

- ❑ *Always load paper into the sheet feeder short edge first.*
- ❑ *Make sure that the paper stack fits under the arrow mark inside the edge guide.*

## Checking the print head nozzles

Once paper is loaded, follow these steps to check the print head nozzles.

### For Windows users

1. Click the Start button, point to Settings, and click Printers.
2. Select the icon for your printer, then click Properties on the File menu. Then click the Utility tab.
3. Click the Nozzle Check button, and follow the on-screen instructions.
4. If the nozzle check page does not print satisfactorily (for example, if any segment of the printed lines is missing), then you should clean the print head. Follow the on-screen instructions on the Nozzle Check utility. If the printout is satisfactory, your printer is now set up and ready to use.
5. Click OK to close the Properties dialog box.

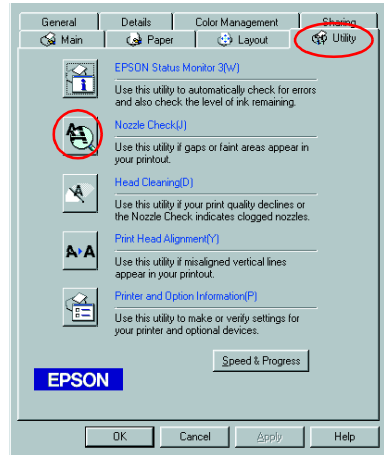

### For Macintosh users

1. Select Page Setup in the Finder's File menu.
2. Click the  utility icon.

3. Click the Nozzle Check button, and follow the on-screen instructions.

4. If the nozzle check page does not print satisfactorily (for example, if any segment of the printed line is missing), then you

should clean the print head. Follow the on-screen instructions on the Nozzle Check utility. If the print out is satisfactory, your printer is now set up and ready to use.

5. Click OK to close the utility dialog box. Then click OK to close the Page Setup dialog box.

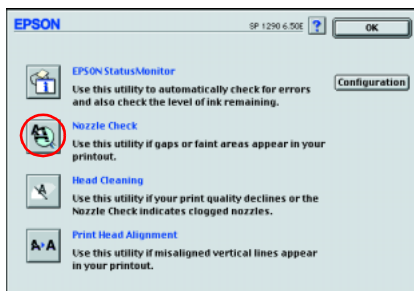

**Caution:**

*Never turn off the printer while the  power light is flashing. Doing so may damage the printer.*

If print quality hasn't improved after repeating the nozzle checking and cleaning procedures four or five times, contact your dealer.

---

## Installing the Photo Print Software

The printer software CD-ROM contains:

- ❑ EPSON PhotoQuicker  
This utility lets you print digital photos with ease, using a wide variety of layouts. You need to install this software in order to use the PRINT Image Matching function.
- ❑ EPSON PhotoStarter (For Windows Me, 98, 2000 and Macintosh users only)  
This utility automatically launches EPSON PhotoQuicker and loads photo data when a memory card is inserted into the PC card slot on the computer. You can also save the photo data in selected folders according to the day they were taken or when the memory card was inserted.
- ❑ EPSON CardMonitor (For Windows Me, 98, 2000 and Macintosh users only)  
This utility works with EPSON PhotoStarter. It monitors the PC card slots on your computer.



### **Caution:**

- ❑ *The handling method varies depending on the memory card type. Be sure to refer to the documentation packaged with your memory card and PC card adapter for details.*
- ❑ *Always back up your original photo data before opening the photos with EPSON PhotoQuicker.*

## System requirements

Item	Windows	Macintosh
<b>Operating system</b>	<p>Microsoft Windows Me, 98, 95, 2000, NT4.0 for EPSON PhotoQuicker</p> <p>Microsoft Windows Me, 98, 2000 for EPSON PhotoStarter and EPSON CardMonitor</p>	Mac OS 8.X / 9.X (except 8.0)
<b>Hardware model</b>	DOS/V system equipped with a standard USB interface or parallel interface. A sound-blaster or compatible sound card is required to reproduce sound.	PowerPC equipped with a standard USB interface (PowerPC G3 266 MHz or higher recommended)
<b>CPU</b>	Pentium 166 MHz or higher (Pentium II 266 MHz or higher recommended)	
<b>Memory</b>	64 MB (128 MB or higher recommended)	42 MB (128 MB or higher recommended)
<b>Display</b>	SVGA (800 × 600) 16-bit color or higher	SVGA (800 × 600) 32,000 colors or higher
<b>Hard disk</b>	<p>Installation: 50 MB or more free space</p> <p>Operation: 170 MB or more free space when handling images of 4.8 million pixels</p>	
<b>CD-ROM Drive</b>	Required	Required

## Installing in Windows

### EPSON PhotoQuicker

1. Insert the printer software CD in the CD-ROM drive. If the Installer dialog box does not appear, double-click EPsetup.exe in the CD-ROM.
2. Select Install EPSON PhotoQuicker, click , then click Next.
3. Follow the on-screen instructions.
4. When a message appears informing you that installation is complete, click Finish.

### EPSON PhotoStarter and EPSON CardMonitor

#### Note:

- ❑ *Before installing EPSON PhotoStarter and CardMonitor, make sure that all the other applications are closed.*
  - ❑ *After installation, you need to restart your computer for the software to function properly.*
1. Insert the printer software CD in the CD-ROM drive. If the Installer dialog box does not appear, double-click EPsetup.exe in the CD-ROM.
  2. Select Install Utility, click , then click EPSON PhotoStarter/EPSON CardMonitor.
  3. Click Next and follow the on-screen instructions.
  4. When a message appears asking if you want to restart your computer, click the Yes radio button and then Finish to restart the computer.

# Installing in Macintosh

## EPSON PhotoQuicker

1. Insert the printer software CD in the CD-ROM drive.
2. Double-click the Installer icon in the EPSON PhotoQuicker folder.
3. Follow the on-screen instructions to install EPSON PhotoQuicker.

## EPSON PhotoStarter and EPSON CardMonitor

### Note:

*EPSON PhotoStarter needs to be installed before EPSON CardMonitor is installed.*

1. Insert the printer software CD in the CD-ROM drive.
2. Double-click the EPSON Memory Card Software folder, then double-click the Installer icon in the EPSON PhotoStarter or EPSON CardMonitor folder.
3. Follow the on-screen instructions to install EPSON PhotoStarter or EPSON CardMonitor.

### Note:

- ❑ *Refer to the online Reference Guide for details on how to access the PhotoPrint Software.*
- ❑ *For details on EPSON PhotoQuicker, you can also view the online User's Guide for PhotoQuicker by clicking the Start menu, then pointing to Programs, then EPSON PhotoQuicker (Windows), or by double-clicking the icon in the EPSON PhotoQuicker folder (Macintosh).*

---

# Printer Parts and Control Panel Functions

---

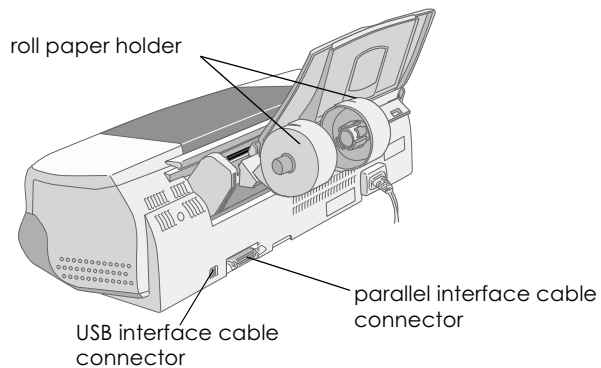
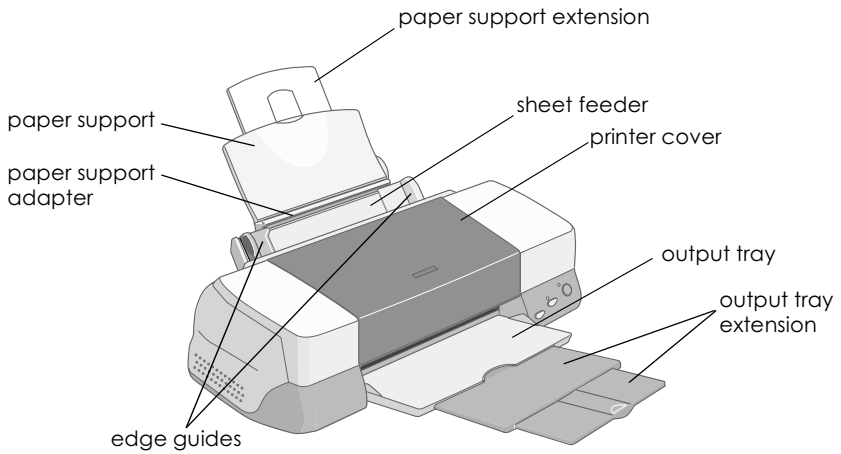

## Printer Parts



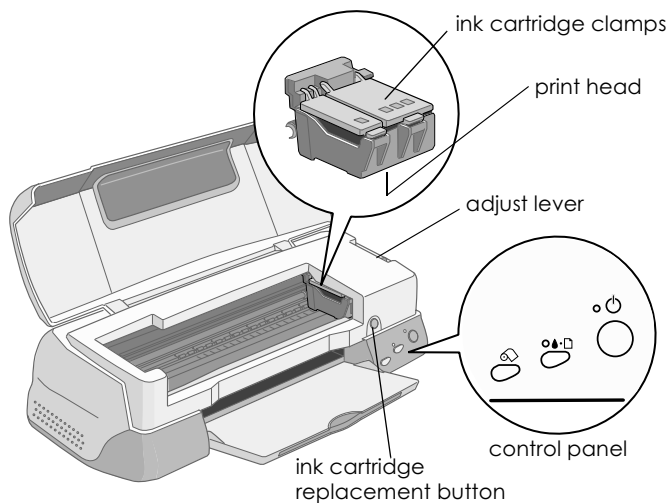









## Buttons

Button	Function
 power	Turns the printer on and off. Clears the printer's memory if pressed twice while the power is on.
 maintenance	Loads or ejects paper if pressed and released within two seconds. Resumes printing if pressed and released after a paper out error. Performs print head cleaning if pressed for 3 seconds when the  error light is off. Moves the print head to the ink cartridge replacement position and charges ink to the printer when ink is out.

Button	Function
 roll paper	Loads and ejects roll paper. Feeds roll paper in reverse to a position where it can be easily removed from the sheet feeder, if pressed for more than 3 seconds. Clears the  error light if pressed after removing roll paper.
 ink cartridge replacement	Moves the print head to the ink cartridge replacement position and charges ink to the printer when ink is out (this orange button is located under the printer cover, not in the control panel).

---

## Lights

Light	Description
 power	On when the printer is on. Flashing when printer is receiving data, printing, replacing an ink cartridge, charging ink, or cleaning the print head.
 error	On when the printer is out of paper. Load paper in the sheet feeder, then press the  maintenance button to resume printing. On when the paper is jammed. Take all of the paper out of the feeder, then reload the paper. If the light continues to flash, turn off the printer and gently pull all of the paper out of the printer. Flashing when the black or color ink cartridge is nearly empty. On when the black or color ink cartridge is empty. Replace the black ink cartridge or color ink cartridge. Black: T007 Standard Capacity T010 Light Capacity Color: T009 (Stylus Photo 1290) T008 (Stylus Photo 890) Flashing when the print head moves to the ink cartridge replacement position. If the color ink is out the light will flash faster than if the black ink is out.

---

## Loading Paper

---

### Loading Special Paper and Other Media

---

You can print on a wide variety of special media, including ink jet paper, photo quality glossy film, photo paper, transparencies, index cards, and adhesive sheets.

### Loading instructions

When loading special media distributed by EPSON, read the instruction sheets packed with the media first and keep the following points in mind.



**Caution:**

*Cleaning sheets packaged with EPSON special media should not be used with this printer. The cleaning function performed by these sheets is not necessary with this type of printer, and the sheets could jam in the printer.*

**Note:**

*For more details on using special media, see “Paper Handling” in the online Reference Guide.*

- ❑ Load the media printable side up in the sheet feeder. See the instruction sheets packed with the media to determine which side is the printable side. Some types of media have cut corners to help identify the correct loading direction, as shown in the illustration.

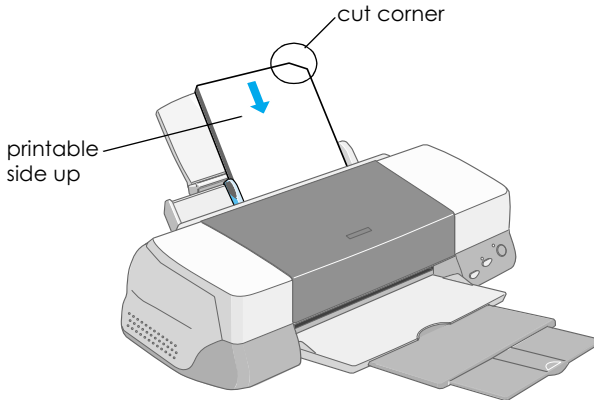

- ❑ Make sure that the paper stack fits under the arrow mark located on the inside surface of the left edge guide.

## Loading capacities for EPSON special media

Refer to the chart below to find the loading capacities for EPSON special media.

Media Type	Loading Capacity
360 dpi Ink Jet Paper and Photo Quality Ink Jet Paper	Up to the arrow mark on the left edge guide.
Photo Quality Ink Jet Cards, Ink Jet Note Cards, and Ink Jet Greeting Cards	Up to 30 index cards. Always place the included support sheet* under the cards.
Photo Quality Glossy Film	One sheet at a time for best results. Always place a support sheet* or a sheet of plain paper under the glossy film. If you wish to load multiple sheets, set the minimum top margin of the page to 30 mm and load a maximum of 20 sheets for A4. For A3 and Super A3 size, you can load up to 5 sheets at a time (only for Stylus Photo 1290).
Ink Jet Transparencies	Up to 30 transparencies. Always put a sheet of plain paper under the stack of transparencies.
Photo Quality Self Adhesive Sheets	One sheet at a time.
Photo Paper	Up to 20 sheets of 4 × 6 inch Photo Paper. Always place a support sheet* under the stack of Photo Paper. One sheet at a time for 200 × 300 mm Photo Paper.
Photo Stickers 16 and Photo Stickers 4	One sheet at a time. Always put the included support sheets* A and B under the stack of Photo Stickers.
Panoramic Photo Paper and Iron-On Cool Peel Transfer Paper	One sheet at a time.

Media Type	Loading Capacity
Matte Paper-Heavyweight	Up to 20 sheets. Always place a support sheet* under the stack of Matte Paper-Heavyweight. For A3 and Super A3 size, you can only load one sheet at a time (only for Stylus Photo 1290).
Premium Glossy Photo Paper	One sheet at a time.
Ink Jet Back Light Film (only for Stylus Photo 1290)	One sheet at a time. Always put a sheet of plain paper under back light film.

\* Take care not to print on support sheets that are loaded under special media.

---

## Loading Envelopes

When printing on envelopes, please note the following:

- You can load up to 10 envelopes at a time in the sheet feeder.

**Note:**

*The folding quality and thickness of envelopes vary widely. If the total thickness of the stack of envelopes exceeds 10 mm, press each envelope in the stack flat before loading. If print quality declines when a stack of envelopes is loaded, load one envelope at a time.*

- Set the adjust lever to the “+” position. To do this, open the printer cover and reposition the lever.

**Note:**

- Return the adjust lever to the “0” position, which is the normal position, after you finish printing on envelopes. Leaving the lever in the “+” position may cause gaps to appear in images printed on other media.*
- When the adjust lever is in the “+” position, make sure the High Speed setting in the printer driver’s Advanced dialog box is off. To turn this option off, you may also need to change the Print Quality setting.*

- ❑ Load envelopes flap edge first with the flap side down, as shown in the illustration.

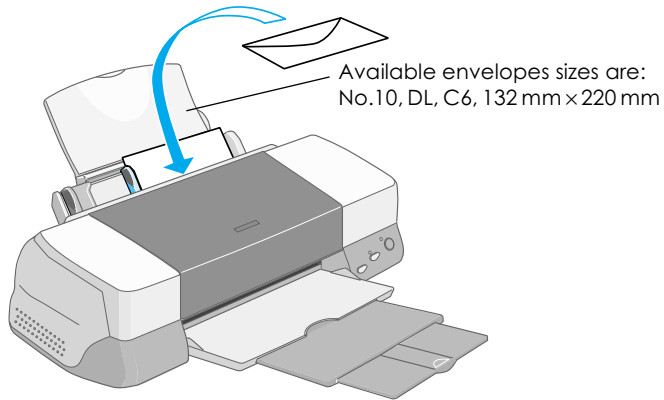

- ❑ Do not use envelopes that are curled or folded.
- ❑ Flatten envelopes before loading.
- ❑ Avoid using envelopes that are too thin as they may curl during printing.
- ❑ Select Plain Paper as the Media Type setting in the printer software.

---

## Using Roll Paper

---

### Using the Roll Paper Holder

With the Roll paper holder packed with the printer, you can print in roll paper format which is convenient for banner printing. When you are printing using the Roll paper holder, keep the following in mind.

- ❑ Load the paper printable side up.
- ❑ Use flat, undamaged paper. If the paper is curled, flatten it before loading to avoid paper feeding problems.
- ❑ Always handle the paper by the edges.
- ❑ Provide ample space in front of the printer for the paper to eject fully.
- ❑ Make sure that the output tray is down and the output tray extension is closed.
- ❑ Check that the end of the paper is cut cleanly, perpendicular to the long axis of the paper. If it is cut on a diagonal or not cleanly, the paper may not feed smoothly or the print may extend off the edge of the paper.
- ❑ EPSON recommends using media distributed by EPSON to ensure high-quality results.



## Loading the Roll Paper

Follow the directions below to mount the Roll paper holder and load the roll paper.

1. Set roll paper in the roll paper holder.

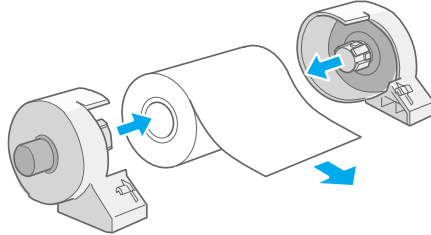

**Note:**

*Remove the transparent sheet after setting the roll paper into the holders.*

2. Check that the end of the roll is cut perpendicularly to the edges as shown. For A4 and 329-mm width paper, cut along one of the parallel lines on the back. For 89- and 100-mm width paper, use a triangle.

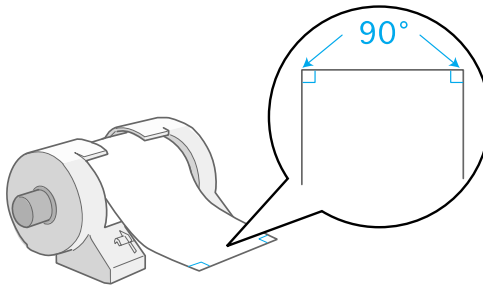

**Caution:**

*Always use a triangle or other tool to ensure that the end of the roll is cut perpendicularly. A diagonal cut may cause paper feed problems.*

3. To uncurl the paper, roll the paper inside the protective film packaged with the printer in the direction opposite to the paper's curl, as shown below.

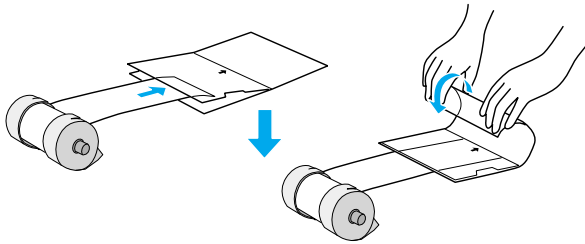

4. Remove the paper support and lower the output tray. Then, turn on the printer.

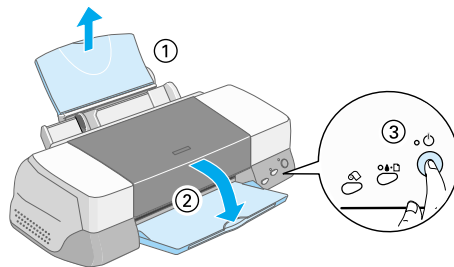

5. Attach the roll paper holder to the printer. Adjust the first left of slot in the back of printer and insert roll paper holder into slots.

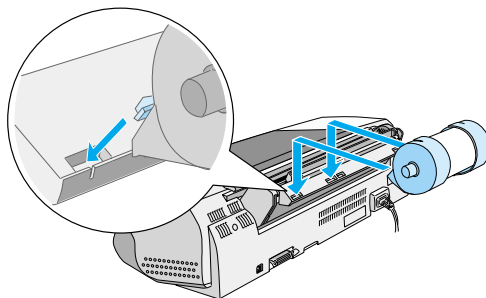

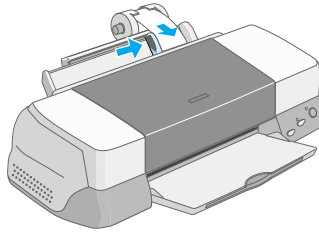

6. Gently insert the end of the paper into the printer as far as it will go, flush with the right edge guide. Slide the left edge guide against the left edge of the paper.

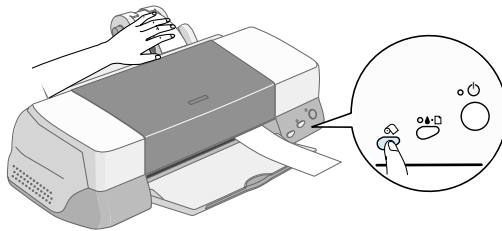

7. To load the paper correctly, you must hold the paper in place with your hand while you press the  roll paper button. The paper feeds into the printer.



8. Open the printer cover and make sure that the paper is feeding correctly. If it is not straight, depress the  roll paper button for more than three seconds to eject the paper. The error light is on. Press the  roll paper button to clear the error, then feed the paper again.

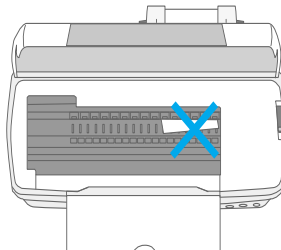

The roll paper is now loaded. Next, set up the printer software and try printing. For details on setting up the printer software, refer to “Printing on Roll Paper” in the online *Reference Guide*.

---



## Removing the Roll Paper from the Printer

After the print job is complete, press the  roll paper button; a line is printed on the roll paper indicating where to cut the paper. Follow the directions below to remove the paper from the printer.

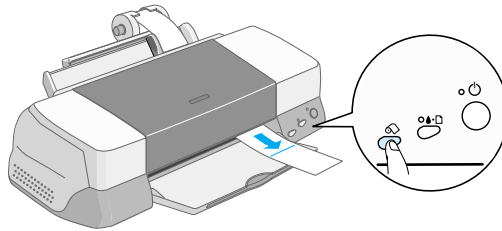
1. Press the  roll paper button to feed the paper. This time, a cutting guide line is printed.



### Note:

- ❑ *If you want to print more data on the same sheet of paper, press the  roll paper button and send the next print job. The paper will return to the printing start position before starting the next print job.*
  - ❑ *You must press the  roll paper button; otherwise, the printer will not operate even if you send a new print job. However, do not press the  roll paper button more than is necessary; repeated motion may damage the printout.*
2. Cut the paper along the printed line. Never pull the paper as you cut it. Doing so may damage the printout. When cutting the paper, do not cut inside the line (closer to the printer) as this may cause paper feed problems.

**Note:**

*EPSON recommends that you use a triangle or other tool to ensure that the end of the roll is cut perpendicularly. A diagonal cut may cause paper feed problems.*

3. Once you have cut the paper, hold down the  roll paper button for about 3 seconds. The paper feeds in reverse to a position where it can be easily removed from the sheet feeder at the back of the printer. If it does not feed to this position, repeat this step.

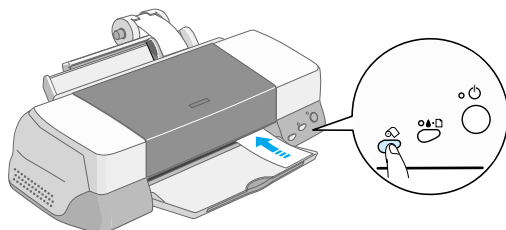

4. Gently remove the paper. Then, press the  roll paper button to clear the error light.

Your document has now been printed.

---

## Printing with PRINT Image Matching

---

### How is PRINT Image Matching used?

The PRINT Image Matching function can be utilized if this EPSON printer is used to print images from input devices, such as digital cameras, loaded with the PRINT Image Matching function. Print commands are attached to image data for printing if photos are taken with an input device loaded with the PRINT Image Matching function.

#### Note:

- ❑ *See the relevant input device instruction manual for details concerning the use of devices loaded with the PRINT Image Matching function.*
- ❑ *Please check with the input device manufacturer to determine whether it is loaded with the PRINT Image Matching function.*

## Printing with a PC

### For Windows

To launch EPSON PhotoQuicker, click Start, point to Programs and then EPSON PhotoQuicker, then click EPSON PhotoQuicker3.x. Then, just specify the desired image to enable easy printing.

## For Macintosh

To launch EPSON PhotoQuicker, double-click the Macintosh HD icon, then double-click the folder in which EPSON PhotoQuicker3.x has been installed. Double-click the EPSON PhotoQuicker3.x icon. Then, just specify the desired image to enable easy printing.



\* Enable or disable the function here

### Note:

- ❑ For details on EPSON PhotoQuicker, you can also view the online User's Guide for PhotoQuicker by clicking the Start menu, then pointing to Programs, then EPSON PhotoQuicker (Windows) or in the EPSON PhotoQuicker folder (Macintosh).
- ❑ EPSON PhotoQuicker lets the user decide whether or not the PRINT Image Matching function is to be used.
- ❑ If EPSON PhotoQuicker is not used, and printing is performed from general retouch software that does not support PRINT Image Matching, the PRINT Image Matching function cannot be used.

## *Media for which PRINT Image Matching is enabled*

PRINT Image Matching is enabled when the following media are used:

Plain Paper/EPSON Premium Ink Jet Plain Paper/  
EPSON Bright White Ink Jet Paper/EPSON Photo Paper/  
EPSON Premium Glossy Photo Paper/  
EPSON Premium Semigloss Photo Paper/



---

# Printing with Windows

---

## Printer Software Introduction

The printer software which comes with your printer includes a printer driver and printer utilities. The printer driver lets you choose from a wide variety of settings to get the best results from your printer. The printer utilities help you check the printer and keep it in top operating condition.

### Accessing the printer software

After you open your application program and create your document, you are ready to select your printer software settings. From the File menu, click Print. You see your application's Print dialog box.

Make sure your printer is selected in the dialog box. Once you click Properties, Printer, Setup or Options (Depending on your application, you may need to click a combination of these buttons.), you see your printer software dialog box.

**Note:**

*You can get specific help related to any item on a menu by right-clicking the item and then clicking the What's This? command.*

---

## Making Settings on the Main Menu

You can make Media Type, Mode, Ink, and Print Preview settings on the Main menu.

### Note:

*You should always make the Media Type setting first, as this setting determines what other settings are available.*

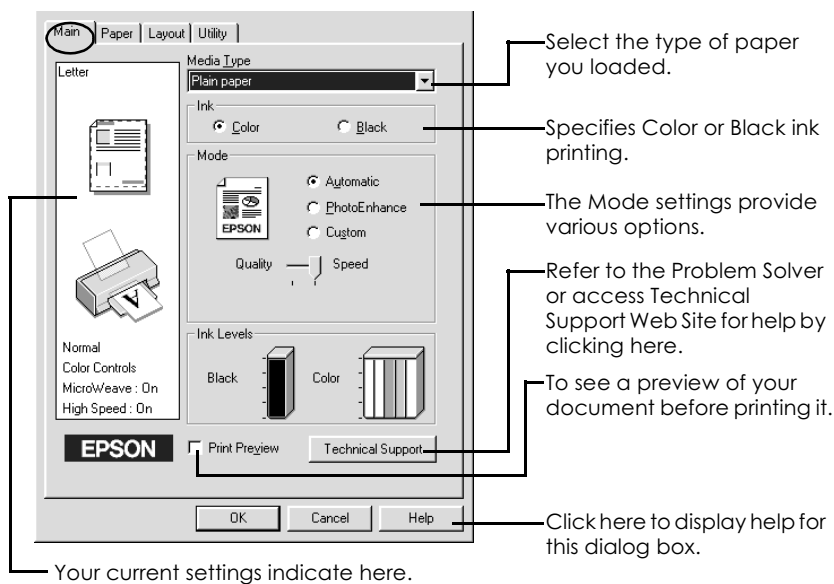

For more information about the Main menus, see your online *Reference Guide*.

### Note:

*For the latest information on available media, visit our regional customer service web site. See "Regional Customer Services" on page 75.*

# Making Settings on the Paper Menu

Use the settings on the Paper menu to change the paper size, set the number of copies and other copy parameters, specify the paper orientation, and adjust the printable area.

The settings which are available vary depending upon whether the sheet feeder or the roll paper is selected as the Paper Source setting.

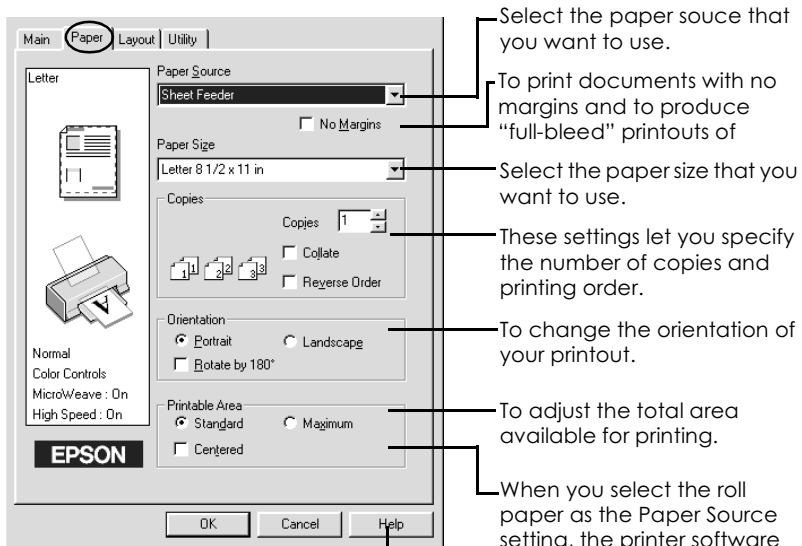

Click here to display help for this dialog box.

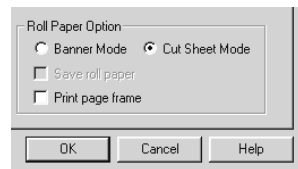

For more information about the Paper menus and the Roll Paper settings, see your online *Reference Guide*.

---

## Making Settings on the Layout Menu

You can make Reduce/Enlarge, Double-Sided Printing, Multi-Page, and Watermark settings on the Layout menu.

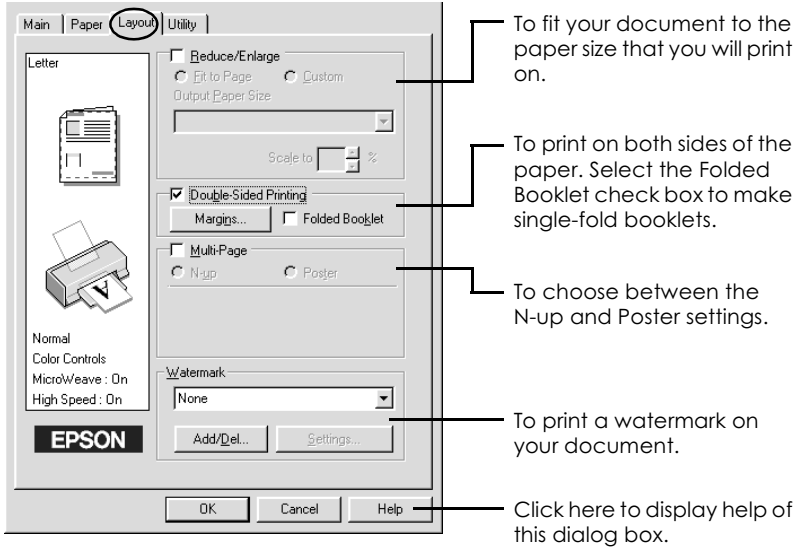

For more information about the Layout menus, see your online *Reference Guide*.

---

# Printing with Macintosh

---

## Printer Software Introduction

---

The printer software which comes with your printer includes a printer driver and printer utilities. The printer driver lets you choose from a wide variety of settings to get the best results from your printer. The printer utilities help you check the printer and keep it in top operating condition.

For information on using the printer utilities, see “Using the Printer Utilities” in the online *Reference Guide*.

You can also get more information about the printer software by clicking the help icon in any of the dialog boxes in the printer software.

If you encounter any problems when using the printer software, refer to the EPSON Technical Support Web Site. To access the web site from the printer software CD-ROM, insert the CD in the CD-ROM drive and open the Install Printer Driver/Utility folder in the EPSON folder, and then double-click the Technical Support Web Site icon.

---

## Making settings in the Print dialog box



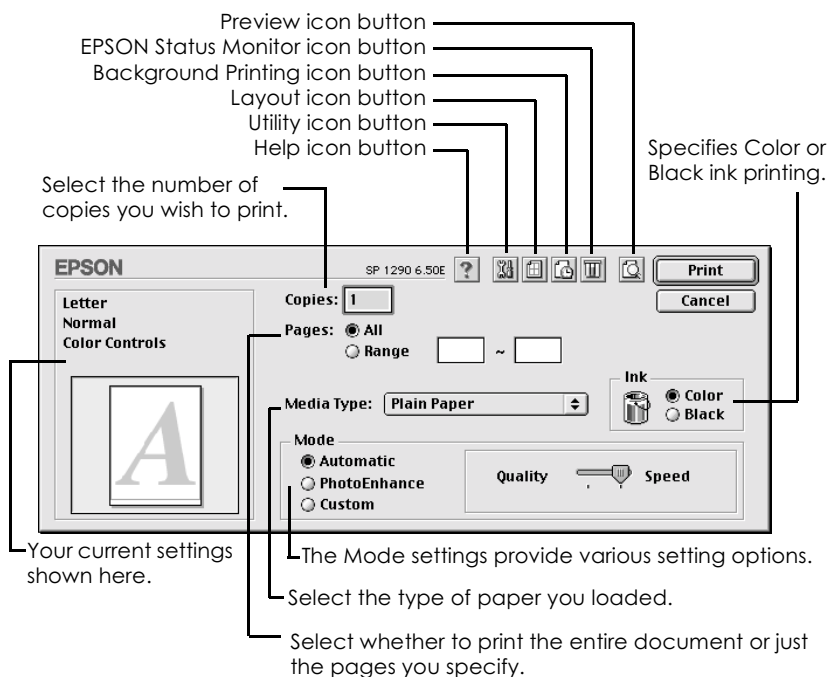

You can make Media Type, Mode, Ink, Copies, and Pages settings in the Print dialog box. From this dialog box, you can also access other dialog boxes, from which you can set the print time, preview the document before printing, and save spool data as a file.

### Note:

*You should always make the Media Type setting first, as this setting determines what other settings are available.*



### Note:

❑ Use the  Preview icon button to toggle between the  Print,  Preview, and  Save File modes. Click the icon button to select the mode that you want. For details, see your online Reference Guide.

❑ For the latest information on available media, visit our regional customer service web site. See "Regional Customer Services" on page 75.

# Making **settings** in the **Page Setup** dialog box

In the Page Setup dialog box, you can change the paper size, specify the paper orientation, print on both sides of the paper, rotate your document by 180 degrees, reduce or enlarge your printout, and adjust the printable area.

The image shows the EPSON Page Setup dialog box with several callouts pointing to specific settings:

- Paper Source:** Select the paper source that you want to use.
- Paper Size:** Select the paper size that you want to use.
- No Margins:** To print document with no margins and to produce "full-bleed" printouts of image.
- Orientation:** Portrait or Landscape.
- Rotate by 180 degrees:** Check this box to rotate the document.
- Double-Sided Printing:** Check this box to print on both sides of the paper.
- Margins...:** Click this button to adjust the margins.
- Reduce or Enlarge:** 100% (You can reduce or enlarge your document.)
- Printable Area:** Standard (selected), Maximum, or Centered.
- Roll Paper Option:** Banner, Cut sheet (selected), Save roll paper, or Print page frame.

When you select the roll paper as the Paper Source setting, the printer software will appear as shown below.

For more information about the Page Setup dialog box and the Roll Paper settings, see your online *Reference Guide*.

---

## Making **settings** in the **Layout** dialog box

You can modify the page layout of your document using the printer driver settings located in the Layout dialog box. To open this dialog box, click Print on the File menu of your application, then click the  Layout icon button in the Print dialog box.

Automatically adjusts the size of your document to match the paper size used by your printer.

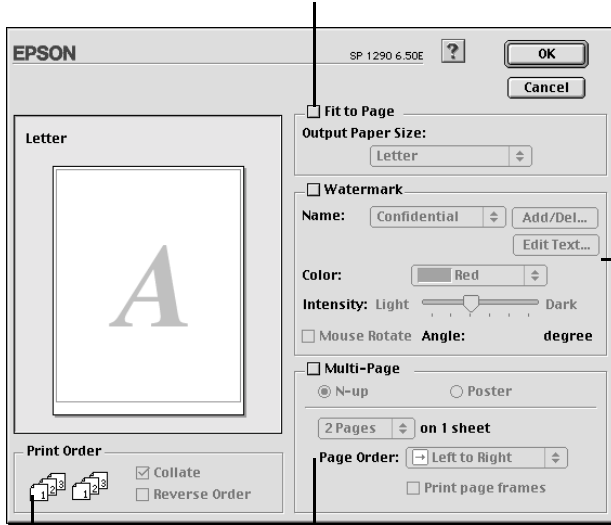

Specify the printing order for your print job.

To choose between the N-up and Poster settings.

Prints a watermark in the background of your document.

For more information about the Layout dialog box, see your online *Reference Guide*.



---

# Replacing Ink Cartridges

---

## Using the Printer's Control Panel

---

This printer uses ink cartridges equipped with IC chips. The IC chip accurately monitors the amount of ink used by each cartridge, so even if a cartridge is removed and later inserted again, all of its ink can be used. However, some ink is consumed each time the cartridge is inserted because the printer automatically checks reliability.

You can replace an ink cartridge using the printer's control panel or using the Status Monitor utility. To replace an ink cartridge using the  ink cartridge replacement button on the printer's control panel, follow the steps below. To replace an ink cartridge or check ink levels using the Status Monitor utility, refer to "Using the Status Monitor" in the online *Reference Guide*.



### **Warning:**

- ❑ *Keep ink cartridges out of the reach of children. Do not allow children to drink from or otherwise handle the cartridges.*
  
- ❑ *Be careful when you handle the used ink cartridges, as there may be some ink around the ink supply port. If ink gets on your skin, wash the area thoroughly with soap and water. If ink gets into your eyes, flush them immediately with water. If discomfort or vision problems remain after a thorough flushing, see a physician immediately.*



**Caution:**

- ❑ *EPSON recommends the use of genuine EPSON ink cartridges. Other products not manufactured by EPSON may cause damage to your printer not covered by EPSON's warranties.*
- ❑ *Leave the old cartridge installed in the printer until you have obtained a replacement; otherwise, ink remaining in the print head nozzles may dry out.*
- ❑ *Do not refill the ink cartridges. The printer calculates the amount of ink remaining using an IC chip on the ink cartridge. Even if the cartridge is refilled, the amount of ink remaining will not be recalculated by the IC chip and the amount of ink available for use will not change.*

**Note:**



- ❑ *You cannot continue printing with one ink cartridge empty, even if the other cartridge still contains ink. Before printing, replace the empty cartridge.*
- ❑ *In addition to the ink used during document printing, ink is consumed during the print head cleaning operation, during the self-cleaning cycle which is performed when the printer is turned on, and during ink charging when the ink cartridge is installed in the printer.*







For more information about ink cartridges, see “When handling the ink cartridges” on page 3.

1. Make sure that the printer is on, but not printing. Then, open the printer cover.

**Note:**

*You can identify the status of the printer condition. When the error light is flashing, the black or color ink cartridge is low. When the error light is on, the black or color ink cartridge is empty.*

- Press down the  ink cartridge replacement button. The print head moves left to the Ink cartridge replacement position. The  power light begins to flash, and the  error light begins to flash or remains on. To discover which cartridge requires replacing, refer to the table below, or check EPSON Status Monitor 3 (for Windows) or EPSON StatusMonitor (for Macintosh).

Lights	Action
	Replace the black ink cartridge if the  error light flashes at the same speed as the power light.
	Replace the color ink cartridge if the  error light flashes at twice the speed of the  power light.
	Replace both the black and color ink cartridges if this light remains on.

● = on, ○ = off, ◐ = flashing



**Caution:**

*Do not move the print head by hand, as this may damage the printer. Always press the  ink cartridge replacement button to move it.*

- Lift up the ink cartridge clamp as far as it will go. Take the cartridge out of the printer. If the cartridge is empty, dispose of it properly. Do not take the used cartridge apart or try to refill it.



**Warning:**

*If ink gets on your hands, wash them thoroughly with soap and water. If ink gets into your eyes, flush them immediately with water. If discomfort or vision problems remain after a thorough flushing, see a physician immediately.*

4. Remove the new ink cartridge from its protective bag and then only peel off the yellow tape seal. Do not touch the green chip on the side of the cartridge.

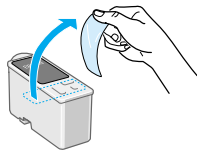

black ink cartridge  
Standard Capacity (T007)  
Light Capacity (T010)

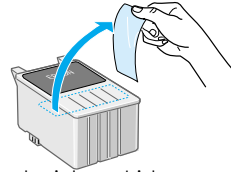

color ink cartridge  
Stylus Photo 1290 (T009)  
Stylus Photo 890 (T008)



**Caution:**

- ❑ You must remove the yellow tape seal from the cartridge before installing it; otherwise, the cartridge will become unusable and you will be unable to print.
- ❑ If you have installed an ink cartridge without removing the yellow tape seal, you must remove the cartridge and install a new one. Prepare the new cartridge by removing the yellow tape seal, then install it in the printer.
- ❑ Do not remove the blue portion of the tape seal from the top of the cartridge; otherwise, the print head may become clogged and be unable to print.
- ❑ Do not remove the tape seal from the bottom of the cartridge; otherwise, ink will leak.
- ❑ Do not remove the green IC chip from the side of the cartridge. If you install an ink cartridge without an IC chip, the printer may be damaged.
- ❑ Do not touch the green IC chip on the side of the cartridge; otherwise, normal operation and printing may not be possible.

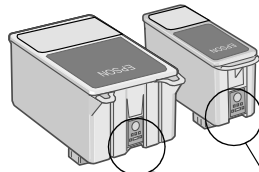

Do not touch this part.



- Align the tabs on the ink cartridge so that they are resting on the tabs protruding from the base of the opened ink cartridge clamp. Push the clamps down until they lock firmly into place.

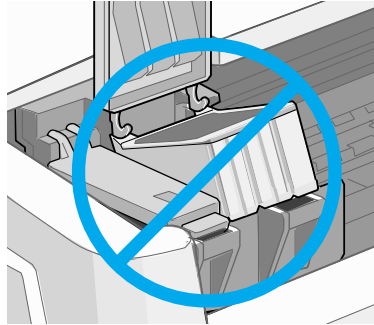

**Caution:**

- Make sure that the ink cartridge tabs are not under the hinges protruding from the base of the opened ink cartridge clamp, as this could damage the clamp.



- After you remove an ink cartridge from the printer, please insert a new one immediately. If no cartridge is present, the print head may dry out and become unable to print.
- Press the  ink cartridge replacement button. The printer moves the print head and begins charging the ink delivery system. This process takes about one minute to complete. When the ink charging process is finished, the printer returns the print head to its home position, the  power light stops flashing and remains on and the  error light goes out.



**Caution:**

- The  power light continues to flash while the printer is charging ink. Never turn off the printer while this light is flashing. Doing so can result in incomplete charging of ink.

- Close the printer cover.

---

# Troubleshooting

## Online problem solving

You can use online problem solving to diagnose and solve most of the problems you may encounter. Refer to the appropriate section below.

### For Windows users

The Problem Solver provides you with tips to help solve any problems you may encounter when using your printer. Depending on your location, the Problem Solver may not be accessible. In this case, you can access Technical Support Web Site instead of the Problem Solver.

If you encounter a problem, access the Problem Solver or Technical Support in one of the following ways:

- From the Windows Start menu

Click Start, point to Programs and then to Epson, then click ESP 1290/890 Problem Solver or Technical Support.

- From Status Monitor 3

Click Technical Support in the Status Monitor 3 dialog box.

- From your printer software

Click Technical Support on the Main menu of the printer software.

If you access the Problem Solver and cannot solve your problem, contact Technical Support for assistance by clicking the Technical Support Web Site link in the Problem Solver.









## *For Macintosh users*

EPSON's Technical Support Web Site provides help with problems that cannot be solved using the troubleshooting information in your printer documentation.



To access Technical Support, insert the CD in the CD-ROM drive and open the Install Printer Driver/Utility folder in the EPSON folder, and then double-click the Technical Support Web Site icon.

# Error Indicators

You can identify many common printer problems using the lights on your printer's control panel. If the lights are on or flashing, use the following table of panel light patterns to diagnose the problem, then follow the recommended corrective measures.

Lights	Problem and Solution	
 	<b>Paper out</b>	
	No paper is loaded in the printer.	Check EPSON Status Monitor 3 or EPSON StatusMonitor. Load paper in the sheet feeder, then press the  maintenance button. The printer resumes printing and the light goes out.
 	<b>Paper jam</b>	
	Paper has jammed in the printer.	Check EPSON Status Monitor 3 or EPSON StatusMonitor. Press the  maintenance button to eject the jammed paper. If the error does not clear, open the printer cover and remove all of the paper inside, including any torn pieces. Then, reload the paper in the sheet feeder and press the  maintenance button to resume printing.
 	<b>Ink low</b>	
	The black or color ink cartridge is nearly empty.	Obtain a replacement black or color ink cartridge. To determine which cartridge is nearly empty, check the ink level using EPSON Status Monitor 3 or EPSON StatusMonitor.  Black: T007 (Standard Capacity) T010 (Light Capacity) Color: T009 (Stylus Photo 1290) T008 (Stylus Photo 890)



Lights	Problem and Solution	
	<b>Ink out</b>	
	<p>The black or color ink cartridge is empty or not installed.</p>	<p>Replace the black or color ink cartridge with a new one. See "Replacing Ink Cartridges" on page 54 for details.</p> <p>Black: T007 (Standard Capacity) T010 (Light Capacity)</p> <p>Color: T009 (Stylus Photo 1290) T008 (Stylus Photo 890)</p>
	<b>Wrong cartridge</b>	
	<p>The installed black or color ink cartridge cannot be used by this printer.</p>	<p>Use the appropriate black or color ink cartridge. See "Replacing Ink Cartridges" on page 54 for details.</p> <p>Black: T007 (Standard Capacity) T010 (Light Capacity)</p> <p>Color: T009 (Stylus Photo 1290) T008 (Stylus Photo 890)</p>
	<b>Carriage error</b>	
	<p>The print head carriage is obstructed by jammed paper or other foreign material and cannot return to the home position.</p>	<p>Turn off the printer. Open the printer cover and remove any paper from the paper path by hand. Then, turn the printer back on.</p> <p>If the error does not clear, contact your dealer.</p>
	<b>Unknown printer error</b>	
	<p>An unknown printer error has occurred.</p>	<p>Turn off the printer and contact your dealer.</p>



● = on, ○ = off, ◐ = flashing

---

# Maintenance

To keep your printer in good working condition, use the following utilities included in your printer software. To determine which utility to use, locate your problem in the list, then try the solutions recommended for that problem. If you need help accessing the printer software, see “Printing with Windows” on page 46, or “Printing with Macintosh” on page 50. For more details about maintaining your printer, see your online *Reference Guide*.

Utility	Problem and Solution	
<b>Nozzle Check</b>	The lines, images, or text in your printout contain gaps or are faint.	<p>Make sure that A4 or Letter size paper is loaded in the sheet feeder.</p> <p>For Windows users, access the printer software and click the Utility tab, then click the Nozzle Check button.</p> <p>For Macintosh users, access the Print or Page Setup dialog box and click the  Utility icon button, then click the Nozzle Check button in the Utility dialog box.</p> <p>Follow the on-screen instructions to check the print head nozzles. If any segments are missing or faint in the printed pattern, the print head nozzles may be clogged.</p> <p>Try using the Head Cleaning utility as described below.</p>

Utility	Problem and Solution	
<p><b>Head Cleaning</b></p>	<p>The print head nozzle are clogged.</p>	<p>Make sure that the printer is on and the  error light is off.</p> <p>For Windows users, access the printer software and click the Utility tab, then click the Head Cleaning button.</p> <p>For Macintosh users, access the printer software and click the  Utility icon button, then click the Head Cleaning button.</p> <p>Follow the on-screen instructions to clean the print head.</p>
<p><b>Print Head Alignment</b></p>	<p>The vertical lines in your printout are not aligned correctly.</p>	<p>Make sure that A4 or Letter size plain paper is loaded in the sheet feeder.</p> <p>For Windows users, access the printer software and click the Utility tab, then click the Print Head Alignment button.</p> <p>For Macintosh users, access the printer software and click the  Utility icon button, then click the Print Head Alignment button.</p> <p>Follow the on-screen instructions to align the print head.</p>

---

## **Correcting USB Problems**

If you are having difficulty using your printer with a USB connection, see if your problem is listed below, then follow the instructions given to resolve the problem.

### ***Printer does not work correctly with the USB cable***

If your printer does not work correctly with the USB cable, try one or both of these solutions:

- ❑ Use the USB cable (C83623\*) recommended in “System Requirements” on page 77.
- ❑ For best results, you should connect the printer directly to the computer’s USB port. If you must use multiple USB hubs, we recommend that you connect the printer to the first tier hub.

## **Operating System**

Your computer must be a Windows 98 or Windows 2000 pre-installed model. You may not be able to install or run the USB Printer Driver on a computer which is not equipped with a USB port or which has been upgraded from Windows 95 to Windows 98 or 2000. For Windows Me users, your computer must be a Windows Me pre-install model or upgraded from Windows 98 pre-installed model.

For details about your computer, contact your dealer.

### ***Printer software installation***

Please take notice about the following.

- ❑ When using Windows 2000, you must follow the steps in the Setup Guide to install the printer software; otherwise, Microsoft’s Universal driver may be installed instead. To check if the Universal driver has been installed, open the Printers folder and right-click the icon for your printer. To open the printer driver, click Printing Preferences on the shortcut menu that appears, then right-click anywhere in the driver. If About is displayed in the shortcut menu that appears, click it. A message box with the words “Unidrv Printer Driver” appears. You must reinstall the printer software as described in the Setup Guide. If ABOUT is not displayed, the printer software has been installed correctly.
- ❑ If the Digital Signature Not Found dialog box appears during the installation process, click Yes. If you click NO, you will must follow the steps in the Setup Guide to install the printer software again.

## USB driver installation

For Windows Me, 98 and 2000 users, follow the directions below to ensure that the USB driver is installed correctly.

### Note:

*The illustrations used in this section show the procedure for Windows 98.*

1. Click the Start button, point to Settings, and click Printers. Make sure that the icon for your printer appears in the Printers window.

Select the icon for your printer, then click Properties on the File menu.



2. For Windows 98 users, click the Details tab and make sure that EPUSBx: (EPSON Stylus Photo 1290 or 890) is displayed in the Print to the following port list box. For Windows 2000 users, click the Ports tab and make sure that USBxxx, EPSON Stylus Photo 1290 or 890 is displayed in the Print to the following port(s) list box.

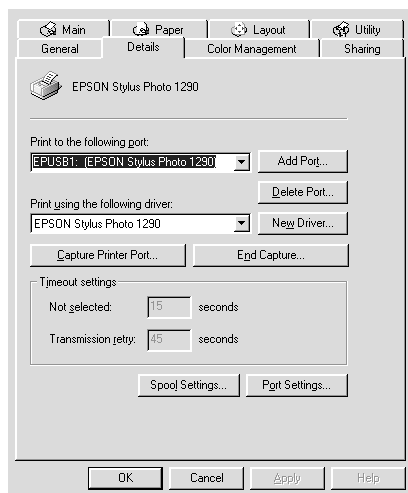

**Note:**

*If the correct port is not displayed, refer to the next section, "Make sure that EPSON USB Printer Devices appears on the Device Manager menu (for Windows Me and 98)".*

### **The Device Manager menu (for Windows Me and 98 only)**

If you canceled the plug-and-play driver installation before the procedure was complete, either the USB printer device driver or the printer software may be incorrectly installed.

Follow the steps below to check the installation and reinstall the drivers.

1. Turn the printer on. Plug the USB cable into the printer and the computer.

2. Right-click the My Computer icon on your desktop, then click Properties.
3. Click the Device Manager tab.

If your drivers are correctly installed, EPSON USB Printer Devices should appear on the Device Manager menu.

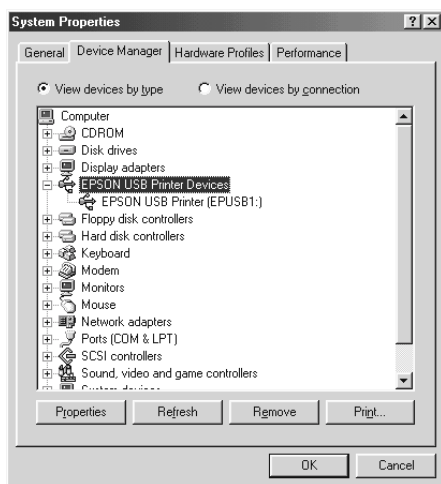

If EPSON USB Printer Devices does not appear on the Device Manager menu, click the plus (+) sign beside Other devices to view the installed devices.



If USB Printer appears under Other devices, the USB printer device driver is not installed correctly. If EPSON Stylus Photo 1290 or 890 appears, the printer software is not installed correctly.

If neither USB Printer nor EPSON Stylus Photo 1290 or 890 appears under Other devices, click Refresh or unplug the USB cable from the printer, then plug it into the printer again.

4. Under Other devices, select USB Printer or EPSON Stylus Photo 1290 or 890 and click Remove. Then, click OK.

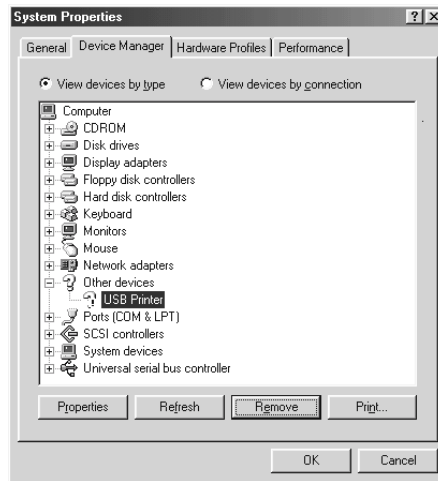

5. When the following dialog box appears, click OK. Then click OK to close the System Properties dialog box.

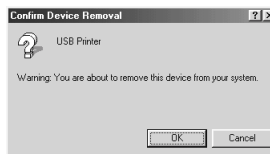

6. Turn off the printer and restart your PC. Then, reinstall the drivers from the beginning, following the instructions in the *Setup Guide*.

**Note:**

*If the problem does not clear, contact your dealer.*



**Reinstall the USB printer device driver and printer software  
(Windows Me and 98 only)**

If the solutions above do not correct the problem, try reinstalling the USB printer device driver and the printer software. First, uninstall EPSON Printer Software using the Add/Remove Programs utility in the Control Panel, then uninstall EPSON USB Printer Devices. Next, reinstall the software as described in *Setup Guide*. If EPSON USB Printer Devices is not registered in the Add/Remove Programs list, access the CD-ROM and double-click epusbun.exe. in Win9x folder. Then follow the on-screen instructions.

---

# Consumable Products

The following ink cartridges and EPSON special media are available for your printer.

## Ink cartridges

You can use the following cartridges with your printer.

Type of ink	Product numbers of ink
Black ink cartridge	Standard Capacity: T007051
Color ink cartridge	Stylus Photo 1290: T009051 Stylus Photo 890: T008051

**Note:**

*The product numbers of ink cartridges may vary by location.*

## Media types

EPSON offers specially-designed media for ink jet printers to meet most high-quality printing needs.

To make the Media Type setting in your printer software, select the Media Type setting that matches the media that is loaded in the printer. To find out what media type you are using, find your media in the list below and refer to the corresponding media type under which it is grouped (shown in larger type). For some media, there are several Media Type settings to choose from.

The available media types are listed below.

**Note:**

*For the latest information on available media, visit our regional customer service web site. See "Regional Customer Services" on page 75 for details.*

## *Plain Paper*

Plain paper

Envelopes

EPSON Premium Ink Jet Plain Paper (A4)	S041214
EPSON Bright White Ink Jet Paper (A4)	S041442

## *360 dpi Ink Jet Paper*

EPSON 360 dpi Ink Jet Paper (A4)	S041059
EPSON 360 dpi Ink Jet Paper (A3)*	S041065
EPSON 360 dpi Ink Jet Paper (Super A3/Super B)*	S041066
EPSON Iron-On Cool Peel Transfer Paper (A4)	S041154

## *Photo Quality Ink Jet Paper*

EPSON Photo Quality Ink Jet Paper (A4)	S041061
EPSON Photo Quality Ink Jet Paper (A3)*	S041068
EPSON Photo Quality Ink Jet Paper (Super A3/Super B)*	S041069
EPSON Photo Quality Ink Jet Cards (A6)	S041054
EPSON Photo Quality Ink Jet Cards (5 × 8")	S041121
EPSON Photo Quality Ink Jet Cards (8 × 10")	S041122
EPSON Photo Quality Self Adhesive Sheets (A4)	S041106

## *Photo Paper*

EPSON Photo Paper (A4)	S041140
EPSON Photo Paper (A3)*	S041142
EPSON Photo Paper (Super A3/Super B)*	S041143
EPSON Photo Paper (4 × 6")	S041134
EPSON Photo Paper Cards (A4)	S041177

## *Ink Jet Transparencies*

EPSON Ink Jet Transparencies (A4)	S041063
-----------------------------------	---------

## *Premium Glossy Photo Paper*

EPSON Premium Glossy Photo Paper (A4)	S041297
EPSON Premium Glossy Photo Paper (A3)*	S041288
EPSON Premium Glossy Photo Paper (Super A3/Super B)*	S041289
EPSON Premium Glossy Photo Paper (100 mm × 8 M)	S041302
EPSON Premium Glossy Photo Paper (89 mm × 7 M)*	S041301

EPSON Premium Semigloss Photo Paper (A4)	S041332
EPSON Premium Semigloss Photo Paper (A3)*	S041334
EPSON Premium Semigloss Photo Paper (SuperA3/SuperB)*	S041328
EPSON Premium Semigloss Photo Paper (100 mm × 8 M)	S041330
EPSON Premium Semigloss Photo Paper (210 mm × 10 M)	S041336
EPSON Premium Semigloss Photo Paper (329 mm × 10 M)*	S041338

\* Only with the EPSON Stylus Photo 1290.

**Note:**

*The availability of special media varies by location.*

---

# Customer Support

---

## Technical Support Web Site

EPSON's Technical Support Web Site provides help with problems that cannot be solved using the troubleshooting information in your printer documentation. If you have a Web browser and can connect to the Internet, access that site at:

<http://w3.epson.com.tw/imaging/service/42/index.htm>

---

## Regional Customer Services

If your EPSON product is not operating properly and you cannot solve the problem using the troubleshooting information in your product documentation, contact customer support services for assistance. If customer support for your area is not listed below, contact the dealer where you purchased your product.

Customer support will be able to help you much more quickly if you give them the following information.

- Product serial number  
(The serial number label is usually on the back of the product.)
- Product model
- Product software version  
(Click About, Version Info, or similar button in the product software.)
- Brand and model of your computer
- Your computer operating system name and version

- ❑ Names and versions of the software applications you normally use with your product.

---

# System Requirements

---

## Using the online Reference Guide

Refer to the appropriate section below for the minimum system requirements necessary to use the online *Reference Guide*.

### For Windows computers

System	Microsoft Windows® Millennium Edition, 98, 95, 2000, or NT® 4.0
CPU	Pentium 150MHz processor (for Windows Me) i486/66 MHz (for Windows 98) (Pentium or better recommended) i486/25 MHz (for Windows 95 and NT 4.0) (Pentium or better recommended) Pentium 133 MHz for Windows 2000
Memory	16 MB RAM for Windows 98, 95, and NT 4.0 (32 MB RAM or more recommended) 32 MB RAM for Windows Me and 2000
Hard disk space	5 MB to install the Reference Guide
CD-ROM drive	Double-speed (quad-speed or faster recommended)
Display	640 × 480 pixel or 800 × 600 pixel resolution, with High Color (16 bit) or True Color (32 bit) setting
Browser	Web browser (Microsoft Internet Explorer 4.0 or later recommended)



## For Macintosh computers

System	Mac OS 8.1/8.5.1/8.6/9.X
Memory	16 MB RAM (32 MB RAM or more recommended)
Hard disk space	5 MB to install the Reference Guide
CD-ROM drive	Double-speed (quad-speed or faster recommended)
Display	640 × 480 pixel or 800 × 600 pixel resolution, with High Color (16 bit) or True Color (32 bit) setting
Browser	Web browser (Microsoft Internet Explorer 4.0 or later recommended)