

# EPSON STYLUS™ C60

Color Ink Jet Printer

All rights reserved. No part of this publication may be reproduced, stored in a retrieval system, or transmitted in any form or by any means, electronic, mechanical, photocopying, recording, or otherwise, without the prior written permission of SEIKO EPSON CORPORATION. The information contained herein is designed only for use with this EPSON printer. EPSON is not responsible for any use of this information as applied to other printers.

Neither SEIKO EPSON CORPORATION nor its affiliates shall be liable to the purchaser of this product or third parties for damages, losses, costs, or expenses incurred by the purchaser or third parties as a result of: accident, misuse, or abuse of this product or unauthorized modifications, repairs, or alterations to this product, or (excluding the U.S.) failure to strictly comply with SEIKO EPSON CORPORATION's operating and maintenance instructions.

SEIKO EPSON CORPORATION shall not be liable for any damages or problems arising from the use of any options or any consumable products other than those designated as Original EPSON Products or EPSON Approved Products by SEIKO EPSON CORPORATION.

SEIKO EPSON CORPORATION shall not be held liable for any damage resulting from electromagnetic interference that occurs from the use of any interface cables other than those designated as EPSON Approved Products by SEIKO EPSON CORPORATION.

EPSON is a registered trademark and EPSON Stylus is a trademark of SEIKO EPSON CORPORATION.

Microsoft and Windows are registered trademarks of Microsoft Corporation.

*General Notice: Other product names used herein are for identification purposes only and may be trademarks of their respective owners. EPSON disclaims any and all rights in those marks.*

Copyright © 2001 by SEIKO EPSON CORPORATION, Nagano, Japan.



Printed on Recycled Paper.



---

# Contents

---

## **Safety Instructions**

---

Important Safety Instructions . . . . .	1
When setting up your printer . . . . .	1
When choosing a place for the printer . . . . .	2
When using the printer . . . . .	3
When handling the ink cartridges . . . . .	3
Information for United Kingdom Users . . . . .	5
Use of options . . . . .	5
Safety information . . . . .	6
Warnings, Cautions, and Notes . . . . .	7

---

## **Printer Parts and Functions**

---

Unpacking the Printer . . . . .	1
Printer Parts and Control Panel Functions . . . . .	2
Printer parts . . . . .	2
Buttons . . . . .	3
Lights . . . . .	4

---

## **Chapter 1 Paper Handling**

---

Loading Plain Paper . . . . .	1-1
Loading Special Paper and Other Media . . . . .	1-2
Loading capacities for EPSON special media . . . . .	1-5
Storing EPSON Photo Paper . . . . .	1-6
Loading Envelopes . . . . .	1-6

---

## **Chapter 2 Printing with Windows**

---

Printer Software Introduction . . . . .	2-1
Getting more information . . . . .	2-1

Accessing the printer software .....	2-2
Making Settings on the Main Menu .....	2-3
Making the Media Type setting .....	2-3
Making the Mode setting .....	2-7
Previewing your printout .....	2-15
Making Settings on the Paper Menu .....	2-19
Making Settings on the Layout Menu .....	2-20
Making Reduce/Enlarge settings .....	2-21
Making Multi-Page settings .....	2-21
Making Watermark settings .....	2-24
Using the Printer Utilities .....	2-27
EPSON Status Monitor 3 .....	2-28
Nozzle Check .....	2-28
Head Cleaning .....	2-29
Print Head Alignment .....	2-29
Speed & Progress .....	2-31
Getting Information Through Online Help .....	2-34
Accessing help from your application .....	2-34
Accessing help from the Windows Start menu .....	2-34

### **Chapter 3 Checking Printer Status and Managing Print Jobs for Windows**

---

Using the Progress Meter .....	3-1
Epson Printing Tips .....	3-2
Error messages .....	3-2
Using EPSON Spool Manager .....	3-3
Using EPSON Status Monitor 3 .....	3-3
Accessing EPSON Status Monitor 3 .....	3-4
Viewing information in EPSON Status Monitor 3 .....	3-4

### **Chapter 4 Using the Printer Software for Macintosh**

---

Printer Software Introduction .....	4-1
Making Settings in the Print Dialog Box .....	4-2
Making the Media Type setting .....	4-2
Making the Mode setting .....	4-7

Setting the print time . . . . .	4-14
Previewing your printout . . . . .	4-15
Saving spool data as a file . . . . .	4-16
Making Settings in the Page Setup Dialog Box . . . . .	4-17
Defining a custom paper size . . . . .	4-19
Making Settings in the Layout Dialog Box . . . . .	4-21
Making the Fit to Page setting . . . . .	4-22
Making Watermark settings . . . . .	4-22
Making Multi-Page settings . . . . .	4-24
Making Print Order settings . . . . .	4-27
Using the Printer Utilities . . . . .	4-27
EPSON StatusMonitor . . . . .	4-28
Nozzle Check . . . . .	4-28
Head Cleaning . . . . .	4-28
Print Head Alignment . . . . .	4-28
Configuration . . . . .	4-29
Getting Information Through Online Help . . . . .	4-30

## ***Chapter 5 Checking Printer Status and Managing Print Jobs for Macintosh***

---

Using EPSON StatusMonitor . . . . .	5-1
Accessing EPSON StatusMonitor . . . . .	5-2
Using the Configuration Settings dialog box . . . . .	5-2
Using EPSON Monitor3 . . . . .	5-4
Accessing EPSON Monitor3 . . . . .	5-4
Managing print jobs using EPSON Monitor3 . . . . .	5-5
Changing the priority of print jobs . . . . .	5-6

## ***Chapter 6 Setting Up Your Printer on a Network***

---

For Windows Me, 98, and 95 Users . . . . .	6-1
Setting up your printer as a shared printer . . . . .	6-1
Accessing the printer through a network . . . . .	6-3
For Windows 2000 Users . . . . .	6-5
Setting up your printer as a shared printer . . . . .	6-6
Accessing the printer through a network . . . . .	6-7

For Macintosh Users . . . . .	6-9
Setting up your printer as a shared printer . . . . .	6-9
Accessing the printer through a network . . . . .	6-11

## **Chapter 7 Increasing the Print Speed**

---

General tips . . . . .	13
Using the Speed & Progress dialog box (Windows only) . . . . .	15
High Speed Copies . . . . .	15
EPSON Printer Port. . . . .	16

## **Chapter 8 Replacing Ink Cartridges**

---

Introduction. . . . .	7-1
Using the Printer's Control Panel. . . . .	7-1
Using the Status Monitor. . . . .	7-9
Checking the Ink Supply . . . . .	7-10
For Windows users . . . . .	7-10
For Macintosh users . . . . .	7-11

## **Chapter 9 Maintenance**

---

Checking the Print Head Nozzles . . . . .	8-1
Using the Nozzle Check utility . . . . .	8-1
Using the control panel buttons . . . . .	8-2
Cleaning the Print Head . . . . .	8-3
Using the Head Cleaning utility . . . . .	8-4
Using the control panel buttons . . . . .	8-7
Aligning the Print Head . . . . .	8-9
For Windows users . . . . .	8-9
For Macintosh users . . . . .	8-10
Cleaning the Printer . . . . .	8-10
Transporting the Printer . . . . .	8-11
Updating and Uninstalling Software . . . . .	8-12
Updating to Windows Me or 98 . . . . .	8-12
Updating the printer software in Windows Me or 2000 . . . . .	8-13

Uninstalling the printer driver . . . . .	8-13
---	------

## **Chapter 10 Troubleshooting**

---

Diagnosing the Problem . . . . .	9-1
Online problem solving . . . . .	9-1
Error indicators . . . . .	9-3
EPSON Status Monitor . . . . .	9-4
Running a printer operation check . . . . .	9-5
Print Quality Problems . . . . .	9-7
Horizontal banding . . . . .	9-7
Vertical misalignment or banding . . . . .	9-8
Color gaps . . . . .	9-9
Incorrect or missing colors . . . . .	9-9
Blurry or smeared printout . . . . .	9-10
Printout Problems Not Related to Print Quality . . . . .	9-12
Incorrect or garbled characters . . . . .	9-12
Incorrect margins . . . . .	9-12
Inverted image . . . . .	9-13
Blank pages print . . . . .	9-13
Printout has smears on the bottom edge . . . . .	9-14
Printing is too slow . . . . .	9-14
Paper Does Not Feed Correctly . . . . .	9-14
Paper does not feed . . . . .	9-15
Multiple pages feed . . . . .	9-16
Paper jams . . . . .	9-16
Paper is not ejected fully or is wrinkled . . . . .	9-17
Printer Does Not Print . . . . .	9-18
All lights are off . . . . .	9-18
Lights came on and then went out . . . . .	9-18
Only the power light is on . . . . .	9-19
Error light is flashing or on . . . . .	9-19
Error light is on and power light is flashing . . . . .	9-20
Correcting USB Problems . . . . .	9-21
USB connections . . . . .	9-21
Windows operating system . . . . .	9-21
Printer software installation . . . . .	9-21
Cancelling Printing . . . . .	9-26

For Windows Me, 98 and 95 users .....	9-26
For Windows 2000 users .....	9-28
For Macintosh users .....	9-29

## **Chapter 11 Options and Consumable Products**

---

Options .....	10-1
Interface cables .....	10-1
Consumable products .....	10-2
Ink cartridges .....	10-2
Media types .....	10-2

## **Appendix A Printer Specifications**

---

Printing .....	A-1
Paper .....	A-1
Paper specifications .....	A-2
Printable area .....	A-5
Ink Cartridges .....	A-7
Mechanical .....	A-9
Electrical .....	A-9
Environmental .....	A-10
Standard and Approvals .....	A-10
System Requirements .....	A-11
For Windows computers .....	A-11
For Macintosh computers .....	A-12

## **Appendix B Customer Support**

---

Technical Support Web Site .....	B-1
Regional Customer Services .....	B-1

## **Glossary**

---



---

# **Safety Instructions**

---

## **Important Safety Instructions**

Read all of the instructions in this section before using your printer. Also, be sure to follow all warnings and instructions marked on the printer.

### **When setting up your printer**

Observe the following when setting up the printer:

- Do not block or cover the openings in the printer's cabinet.
- Use only the type of power source indicated on the printer's label.
- Connect all equipment to properly grounded power outlets. Avoid using outlets on the same circuit as photocopiers or air control systems that regularly switch on and off.
- Avoid electrical outlets controlled by wall switches or automatic timers.
- Keep the entire computer system away from potential sources of electromagnetic interference, such as loudspeakers or the base units of cordless telephones.
- Do not use a damaged or frayed power cord.
- If you use an extension cord with the printer, make sure that the total ampere rating of the devices plugged into the extension cord does not exceed the cord's ampere rating. Also, make sure that the total ampere rating of all devices plugged into the wall outlet does not exceed the wall outlet's ampere rating.

- ❑ Do not attempt to service the printer yourself.
- ❑ Unplug the printer and refer servicing to qualified service personnel under the following conditions:

The power cord or plug is damaged; liquid has entered the printer; the printer has been dropped or the cabinet damaged; the printer does not operate normally or exhibits a distinct change in performance.

- ❑ If you plan to use the printer in Germany, the building installation must be protected by a 10 or 16 amp circuit breaker to provide adequate short-circuit protection and over-current protection for this printer.

**Note for German-speaking users:**

Bei Anschluss des Druckers an die Stromversorgung muss sichergestellt werden, dass die Gebäudeinstallation mit einer 10 A- oder 16 A-Sicherung abgesichert ist.

## ***When choosing a place for the printer***

Observe the following when choosing a place for the printer:

- ❑ Place the printer on a flat, stable surface that extends beyond the printer base in all directions. The printer will not operate properly if it is tilted or at an angle.
- ❑ Leave enough space in front of the printer for the paper to be fully ejected.
- ❑ Avoid places subject to rapid changes in temperature and humidity. Also, keep the printer away from direct sunlight, strong light, or heat sources.
- ❑ Avoid places subject to dust, shocks, and vibrations.
- ❑ Leave enough room around the printer to allow for sufficient ventilation.



- ❑ Place the printer near a wall outlet where the plug can be easily unplugged.

**Note for French-speaking users:**

Placez l'imprimante près d'une prise de contacte où la fiche peut être débranchée facilement.

## ***When using the printer***

Observe the following when using the printer:

- ❑ Do not insert objects through the slots in the printer's cabinet.
- ❑ Take care not to spill liquid on the printer.
- ❑ Do not put your hand inside the printer or touch the ink cartridges during printing.
- ❑ Do not move the print head by hand; otherwise, you may damage the printer.
- ❑ Always turn the printer off using the  power button. When this button is pressed, the  power light flashes. Do not unplug the printer or turn off the power to the outlet until the  power light stops flashing.
- ❑ Before transporting the printer, make sure that the print head is in the home (far right) position and the ink cartridges are in place.

## ***When handling the ink cartridges***

Observe the following when handling the ink cartridges:

- ❑ Keep ink cartridges out of the reach of children. Do not allow children to drink from or otherwise handle the cartridges.

- ❑ Be careful when you handle the used ink cartridges, as there may be some ink remaining around the ink supply port. If ink gets on your skin, wash the area thoroughly with soap and water. If discomfort or vision problems remain after a thorough flushing, see a doctor immediately.
- ❑ Do not shake an ink cartridge; this can cause leakage.
- ❑ Install the ink cartridge immediately after you remove it from its package. Leaving the cartridge unpacked for a long time before use may result in reduced print quality.
- ❑ Do not use an ink cartridge beyond the date printed on the cartridge carton. For best results, use up the ink cartridges within six months of installing them.
- ❑ Do not dismantle the ink cartridges or try to refill them. This could damage the print head.
- ❑ After bringing an ink cartridge inside from a cold storage site, allow it to warm up at room temperature for at least three hours before using it.
- ❑ Store ink cartridges in a cool, dark place.
- ❑ Each time the cartridge is inserted, some ink is consumed because the printer automatically performs a reliability check.
- ❑ Do not touch the green IC chip on the side of the cartridge. This may affect normal operation and printing.
- ❑ The IC chip on this ink cartridge retains a variety of cartridge related-information, such as the amount of ink remaining, so that a cartridge may be removed and reinserted freely. However, each time the cartridge is inserted, some ink is consumed because the printer automatically performs a reliability check.

- ❑ If you remove an ink cartridge for later use, protect the ink supply area from dirt and dust and store it in the same environment as the printer. A valve in the ink supply port makes covers or plugs unnecessary, but the ink may stain items that come in contact with this area of the cartridge. Do not touch the ink supply port or surrounding area.

## **ENERGY STAR® Compliance**



As an ENERGY STAR® Partner, EPSON has determined that this product meets the ENERGY STAR® guidelines for energy efficiency.

The International ENERGY STAR® Office Equipment Program is a voluntary partnership with the computer and office equipment industry to promote the introduction of energy-efficient personal computers, monitors, printers, fax machines, copiers, and scanners in an effort to reduce air pollution caused by power generation.

---

## **Information for United Kingdom Users**

### **Use of options**

EPSON (UK) Limited shall not be liable against any damages or problems arising from the use of any options or consumable products other than those designated as Original EPSON Products or EPSON Approved Products by EPSON (UK) Limited.

## Safety information



### **Warning:**

*This appliance must be earthed. Refer to the rating plate for the voltage and check that the appliance voltage corresponds to the supply voltage.*

**Important:** *The wires in the mains lead fitted to this appliance are coloured in accordance with the following code:*

*Green and yellow – Earth*

*Blue – Neutral*

*Brown – Live*

### **If you have to fit a plug:**

As the colours of the mains lead of this appliance may not match the coloured markings used to identify the terminals in a plug, please observe the following:

- The green and yellow wire must be connected to the terminal in the plug which is marked with the letter E or the earth symbol ( $\perp$ ).
- The blue wire must be connected to the terminal in the plug marked with the letter N.
- The brown wire must be connected to the terminal in the plug marked with the letter L.
- If the plug is damaged, replace the cord set or consult a qualified electrician.
- Replace fuses only with fuses of the correct size and rating.

---

## Warnings, Cautions, and Notes



*Warnings must be followed carefully to avoid bodily injury.*



*Cautions must be observed to avoid damage to your equipment.*

*Notes contain important information and useful tips on the operation of your printer.*





---

# Printer Parts and Functions

---

## Unpacking the Printer

Your printer box should include a CD-ROM containing printer software that runs your printer and the items shown in the illustration.

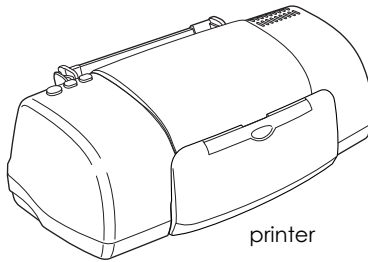

printer

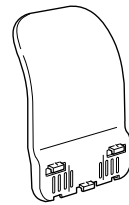

paper support

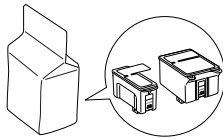

ink cartridges



power cord

In some locations, the power cord comes attached to the printer. The shape of the AC plug varies by country; be sure the plug included is the right shape for your location.

Remove all protective materials packed with your printer before setting up and plugging in the printer. Follow the instructions included with the printer to remove these materials. Save all packaging and protective materials for transporting the printer in the future.

---

# Printer Parts and Control Panel Functions

## Printer parts

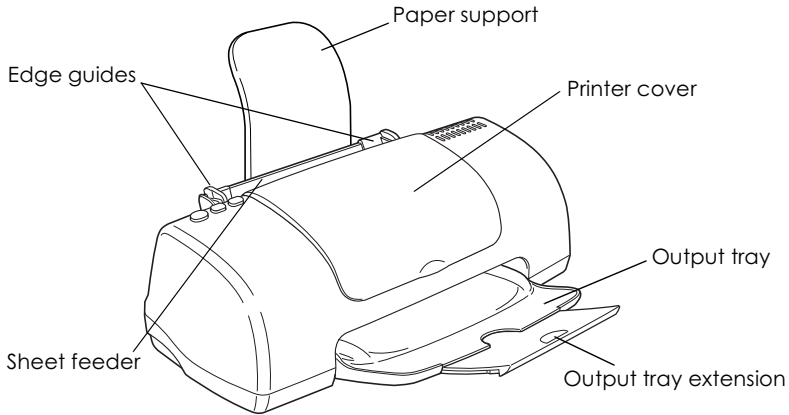

**Paper support:** Supports the paper loaded in the sheet feeder.

**Edge guides:** Help load the paper straight. Adjust the left edge guide to fit the width of your paper.

**Printer cover:** Covers the printing mechanism. Open only when installing or replacing ink cartridges.

**Sheet feeder:** Holds the blank paper and automatically feeds the paper during printing.

**Output tray:** Receives the ejected paper.

**Output tray extension:** Supports the ejected paper.

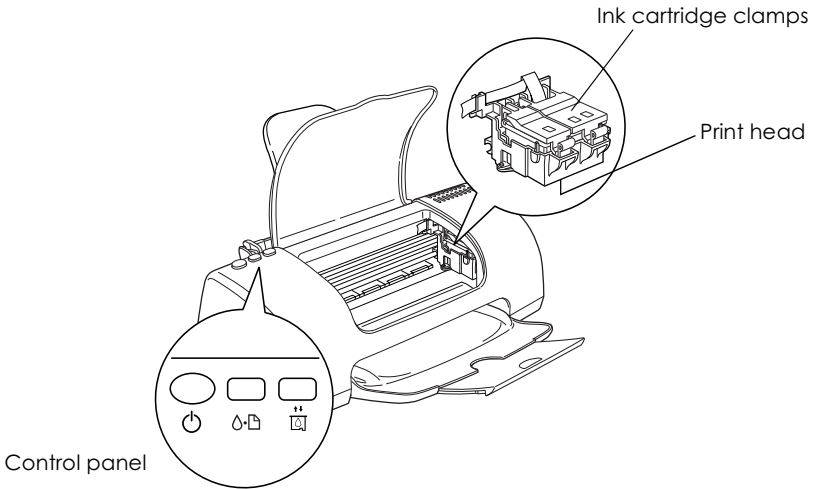





**Ink cartridge clamps:** Hold the ink cartridges in place. Open only when installing or replacing ink cartridges.

**Print head:** Delivers ink to the page.



**Control panel:** Controls various printer functions. See the next section for details.

## Buttons

Button	Function
 power	Turns the printer on and off. Clears the printer's memory if pressed twice while the power is on.

 maintenance	<p>Loads or ejects paper if pressed and released within three seconds.</p> <p>Resumes printing if pressed and released after a paper out error.</p> <p>Performs print head cleaning if pressed for three seconds when the  error light is off.</p> <p>Moves the print head to the ink cartridge replacement position when ink is out.</p>
 ink cartridge replacement	<p>Moves the print head to the ink cartridge replacement position and charges ink to the printer.</p>

## Lights

Light	Description
 power	<p>On when the printer is on.</p> <p>Flashing when printer is receiving data, printing, replacing an ink cartridge, charging ink, or cleaning the print head.</p>
 error	<p>On when the printer is out of paper. Load paper in the sheet feeder, then press the  maintenance button to resume printing.</p> <p>On when the paper is jammed. Take all of the paper out of the feeder, then reload the paper. If the light continues to flash, turn off the printer and gently pull all of the paper out of the printer.</p> <p>Flashing when the black or color ink cartridge is nearly empty.</p> <p>On when the black or color ink cartridge is empty. Replace the black ink cartridge (T028) or color ink cartridge (T029).</p> <p>Flashing when the print head moves to the ink cartridge replacement position. The light will flash faster if the color ink is out than if the black ink is out.</p>

## Loading Plain Paper

---

Follow the steps below to load plain paper in the printer.

1. Lower the output tray. Next, hold down the tab on the edge guide and slide the edge guide so that the distance between the edge guides is slightly wider than the width of your paper.
2. Fan a stack of paper, then tap it on a flat surface to even the edges.
3. Load the stack of paper in the sheet feeder with the printable side up and the right edge of the paper resting against the right edge guide. Then, slide the left edge guide against the left edge of the paper. Make sure that the paper stack is loaded under the tabs inside the edge guides.

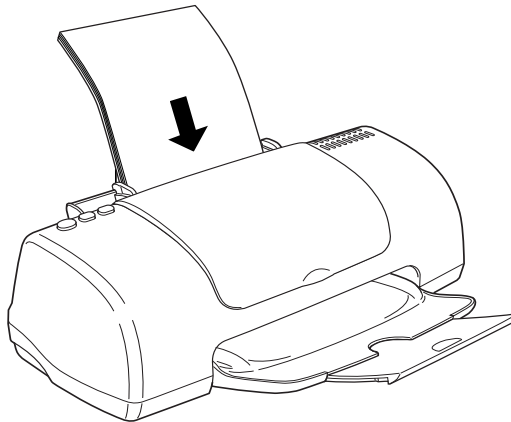

**Note:**

- ❑ *Leave enough space in front of the printer for the paper to be fully ejected.*
- ❑ *Always load paper into the sheet feeder short edge first.*
- ❑ *Make sure that the paper stack fits under the arrow mark inside the edge guide.*

---

## **Loading Special Paper and Other Media**

You can achieve good results with most types of plain bond paper. However, coated paper and glossy film result in higher quality printouts because these media absorb smaller amounts of ink.

EPSON provides special media that are formulated for the ink used in EPSON ink jet printers. EPSON recommends using media distributed by EPSON to ensure high-quality results. See “Media types” on page 11-2 for a complete list of these products.

When loading special media distributed by EPSON, read the instruction sheets packed with the media first and keep the following points in mind.



**Caution:**

*Cleaning sheets packaged with EPSON special media should not be used with this printer. The cleaning function performed by these sheets is not necessary with this type of printer, and the sheets could jam in the printer.*

- ❑ Load the media printable side up in the sheet feeder. See the instruction sheets packed with the media to determine which side is the printable side. Some types of media have cut corners to help identify the correct loading direction, as shown in the illustration.

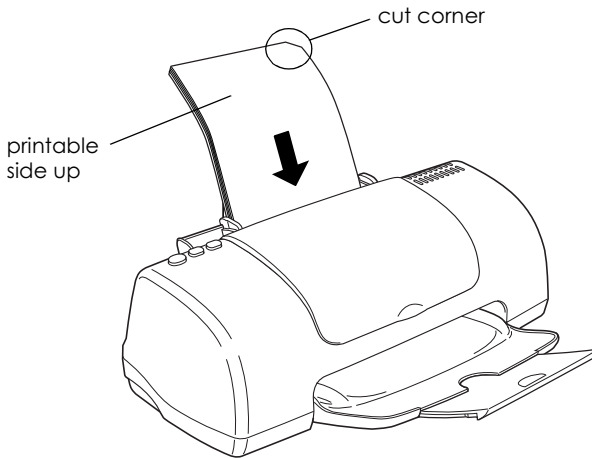

**Note:**

*If you extend the printable area by selecting Maximum as the Printable Area setting in the printer software, the cut corner on special paper may mar your printout.*

- ❑ Make sure that the paper stack fits under the arrow mark located on the inside surface of the left edge guide.
- ❑ Make sure that the paper is loaded under the tabs inside the edge guides.

- ❑ If the paper is curled, flatten it or curl it slightly toward the opposite side before loading. Printing on curled paper may cause ink to smear on your printout, especially when printing with Maximum selected as the Printable Area setting.

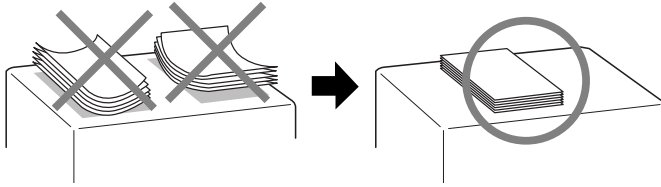

- ❑ If you want to print on the reverse side of an Ink Jet Card with Maximum selected as the Printable Area setting, flatten the card or curl it slightly toward the opposite side before loading.



## Loading capacities for EPSON special media

Refer to the chart below to find the loading capacities for EPSON special media.

Media Type	Loading Capacity
360 dpi Ink Jet Paper	Up to 30 sheets.
Photo Quality Ink Jet Paper	A4, Letter: Up to 30 sheets. Legal: Up to 10 sheets.
Photo Quality Ink Jet Cards, Ink Jet Note Cards, and Ink Jet Greeting Cards	Up to 30 index cards. Always place the included support sheet* under the cards.
Photo Quality Glossy Film	Up to 20 sheets for A4 and Letter size paper. One sheet at a time for A6 size paper. Always place a support sheet* or a sheet of plain paper under the glossy film.
Ink Jet Transparencies	Up to 10 sheets.
Photo Quality Self Adhesive Sheets	One sheet at a time.
Photo Paper	Up to 20 sheets of 4 × 6 inch Photo Paper. Always place a support sheet* under the stack of Photo Paper. One sheet at a time for 200 × 300 mm Photo Paper.
Photo Stickers 16 and Photo Stickers 4	One sheet at a time.
Panoramic Photo Paper and Iron-On Cool Peel Transfer Paper	One sheet at a time.
Matte Paper-Heavyweight	Up to 20 sheets. Always place a support sheet* under the stack of Matte Paper-Heavyweight.
Premium Glossy Photo Paper, Premium Semigloss Photo Paper.	One sheet at a time.

- \* Take care not to print on support sheets that are loaded under special media.

**Note:**

*Make sure that the paper is loaded under the tabs inside the edge guides.*

## **Storing EPSON Photo Paper**

Keep the following points in mind when storing Photo Paper.

- ❑ Return unused paper to its original package as soon as you finish printing and avoid storing it in places exposed to high temperature, humidity, or direct sunlight.
- ❑ EPSON recommends storing your printouts in a resealable plastic bag and keeping them away from high temperature, humidity, and direct sunlight.

---

## **Loading Envelopes**

When printing on envelopes, please note the following:

- ❑ You can load up to 10 envelopes at a time in the sheet feeder.

**Note:**

*The folding quality and thickness of envelopes varies widely. If the total thickness of the stack of envelopes exceeds 10 mm, press each envelope in the stack flat before loading. If print quality declines when a stack of envelopes is loaded, load one envelope at a time.*

- ❑ Load envelopes flap edge first with the flap side down, as shown in the illustration.

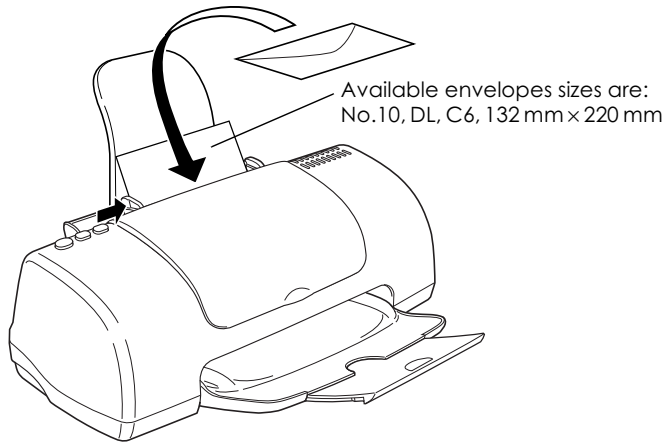

- ❑ Do not use envelopes that are curled or folded.
- ❑ Flatten the envelope flaps before loading.
- ❑ Avoid using envelopes that are too thin as they may curl during printing.
- ❑ Select Plain Paper as the Media Type setting in the printer software.



## Chapter 2

---

# Printing with Windows

---

---

## Printer Software Introduction

The printer software which comes with your printer includes a printer driver and printer utilities. The printer driver lets you choose from a wide variety of settings to get the best results from your printer. The printer utilities help you check the printer and keep it in top operating condition.

The printer driver settings and utilities are on the printer software menus shown below.

<b>Menu</b>	<b>Settings and Utilities</b>
Main	Media Type, Mode, Ink, Print Preview
Paper	Paper Size, Copies, Orientation, Printable Area
Layout	Reduce/Enlarge, Multi-Page, Watermark
Utility	EPSON Status Monitor 3, Nozzle Check, Head Cleaning, Print Head Alignment, Speed & Progress

If you encounter any problems when using the printer software, refer to the Problem Solver HTML manual for help by clicking Technical Support on the Main menu of the printer software.

## Getting more information

For information on using the printer software, see “Making Settings on the Main Menu” on page 2-3, “Making Settings on the Paper Menu” on page 2-19, or “Making Settings on the Layout Menu” on page 2-20.

For information on using the printer utilities, see “Using the Printer Utilities” on page 2-27.

**Note:**

*The specific features available in the printer software vary depending on the version of Windows that you are using.*

Online help provides more information about the printer software. See “Getting Information Through Online Help” on page 2-34 for instructions on accessing help.

## **Accessing the printer software**

You can access the printer software from most Windows applications, or from the Windows Start menu or taskbar.

When you access the printer software from a Windows application, the settings that you make apply only to the application you are using.

When you access the printer software from the Start menu or the taskbar, the settings that you make apply to all of your Windows applications.

Refer to the appropriate section below.

### **From Windows applications**

Follow the steps below to access the printer software.

1. Click Print or Print Setup on the File menu.
2. In the dialog box that appears, click Printer, Setup, Options, or Properties. (Depending on your application, you may need to click a combination of these buttons.) The printer software opens.

## ***From the Start menu***

Follow the steps below to access the printer software.

1. Click Start, point to Settings, then click Printers.
2. For Windows Me, 98 and 95 users, select your printer, then click Properties on the File menu.

For Windows 2000 users, select your printer, then click Printing Preferences on the File menu.

The printer software opens.

## ***From the taskbar***

Right-click the printer icon on the taskbar, then select Printer Settings.

---

## ***Making Settings on the Main Menu***

You can make Media Type, Mode, Ink, and Print Preview settings on the Main menu. Refer to the appropriate section below.

## ***Making the Media Type setting***

The Media Type setting determines what other settings are available, so you should always make this setting first.

On the Main menu, select the Media Type setting that matches the media that is loaded in the printer. To find out what media type you are using, find your media in the list below, and refer to the corresponding media type under which it is grouped (shown in larger type). For some media, there are several Media Type settings from which to choose.

## **Plain Paper**

Plain paper

Envelopes

EPSON Premium Ink Jet Plain Paper (A4) S041214

EPSON Bright White Ink Jet Paper (A4) S041442

## **360 dpi Ink Jet Paper**

EPSON 360 dpi Ink Jet Paper (A4) S041059

S041025

EPSON 360 dpi Ink Jet Paper (Letter) S041060

S041028

EPSON Iron-On Cool Peel Transfer Paper (A4) S041154

EPSON Iron-On Cool Peel Transfer Paper (Letter) S041153

S041155



## **Photo Quality Ink Jet Paper**

EPSON Photo Quality Ink Jet Paper (A4)	S041061 S041026
EPSON Photo Quality Ink Jet Paper (Letter)	S041062 S041029
EPSON Photo Quality Ink Jet Paper (Legal)	S041067 S041048
EPSON Photo Quality Ink Jet Card (A6)	S041054
EPSON Photo Quality Ink Jet Card (5 × 8")	S041121
EPSON Photo Quality Ink Jet Card (8 × 10")	S041122
EPSON Photo Quality Self Adhesive Sheet (A4)	S041106
EPSON Ink Jet Note Cards A6 (with envelopes)	S041147
EPSON Ink Jet Greeting Cards 5 × 8" (with envelopes)	S041148
EPSON Ink Jet Greeting Cards 8 × 10" (with envelopes)	S041149

## **Matte Paper-Heavyweight**

EPSON Matte Paper-Heavyweight (A4)	S041256 S041258 S041259
EPSON Matte Paper-Heavyweight (Letter)	S041257

## **Photo Paper**

EPSON Photo Paper (A4)	S041140
EPSON Photo Paper (Letter)	S041141
EPSON Photo Paper (4 × 6")	S041134
EPSON Photo Paper (100 × 150 mm)	S041255
EPSON Photo Paper (200 × 300 mm)	S041254
EPSON Panoramic Photo Paper (210 × 594 mm)	S041145
EPSON Photo Paper Cards (A4)	S041177

## **Photo Quality Glossy Film**

EPSON Photo Quality Glossy Film (A4)	S041071
EPSON Photo Quality Glossy Film (Letter)	S041072
EPSON Photo Quality Glossy Film (A6)	S041107
EPSON Photo Stickers 16 (A6)	S041144
EPSON Photo Stickers 4 (A6)	S041176

## **Ink Jet Transparencies**

EPSON Ink Jet Transparencies (A4)	S041063
EPSON Ink Jet Transparencies (Letter)	S041064

## **Premium Glossy Photo Paper**

EPSON Premium Glossy Photo Paper (A4)	S041287 S041297
EPSON Premium Glossy Photo Paper (Letter)	S041286
EPSON Premium Semigloss Photo Paper (A4)	S041332
EPSON Premium Semigloss Photo Paper (Letter)	S041331

### **Note:**

*The availability of special media varies by location. For the latest*

information on media available in your area, contact EPSON customer services. See “Regional Customer Services” on page B-1 for details.

## Making the Mode setting

The Mode settings on the Main menu give you three levels of control over the printer software, as explained below.

<b>Automatic</b>	This mode provides the quickest and easiest way to start printing. See “Using the Automatic mode” on page 2-8 for details.
<b>PhotoEnhance</b>	This mode lets you choose from a variety of image-correction settings specially designed for photos. See “Using the PhotoEnhance mode” on page 2-9 for details.
<b>Custom</b>	This mode lets you choose from a list of ready-made or personalized settings suited to the kind of document that you want to print. When Custom is selected, the Advanced button is enabled, allowing you to access the Advanced dialog box. See “Using the Custom mode” on page 2-10 for details.

In addition to making comprehensive Mode settings that affect overall print quality, you can also modify individual aspects of your printout using the Paper and Layout menus. See “Making Settings on the Paper Menu” on page 2-19 or “Making Settings on the Layout Menu” on page 2-20 for details.

## Using the Automatic mode

When Automatic is selected as the Mode setting on the Main menu, the printer software takes care of all detailed settings based on the current Media Type and Ink settings. To make the Ink setting, see “Making the Ink setting” on page 2-15. To make the Media Type setting, see “Making the Media Type setting” on page 2-3.

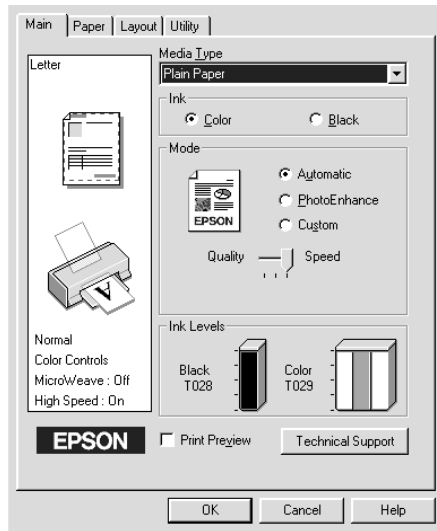

### Note:

- ❑ Depending on the media selected in the Media Type list (while Automatic is selected), a slider appears under the Custom radio button that lets you choose Quality or Speed. Select Quality when print quality is more important than speed.
- ❑ Most Windows applications feature paper size and page layout settings that override similar settings in the printer software. However, if your application does not have these settings, verify the settings on the Paper menu of the printer software.

## Using the PhotoEnhance mode

The PhotoEnhance mode provides a variety of image-correction settings that you can apply to your photos before printing. PhotoEnhance does not affect your original data.

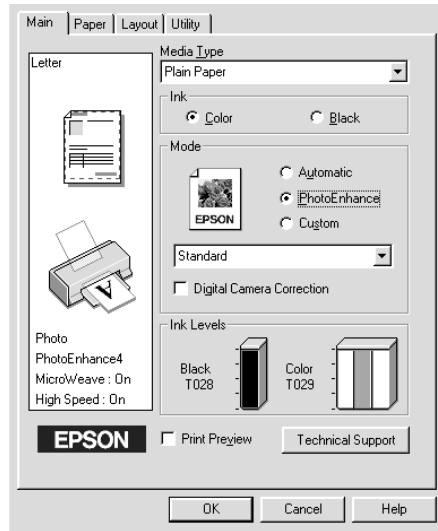

### Note:

- This mode is only available when printing 16-, 24-, or 32-bit color data.
- Printing with PhotoEnhance selected may increase the time required for printing, depending on your computer system and the amount of data contained in your image.

You can select from the following settings.

<b>Standard</b>	This setting provides standard image correction for most photos. Try this first.
<b>People</b>	This setting is best for photos of people.
<b>Nature</b>	This setting is best for outdoor scenery such as mountains, skies, and oceans.

<b>Soft Focus</b>	This setting makes your photos look as if they were taken with a soft-focus lens.
<b>Sepia</b>	This setting applies a sepia tone to your photos.

Selecting PhotoEnhance also enables the Digital Camera Correction check box. Select this check box when you are printing photos taken with a digital camera to give your printed images the smooth, natural appearance of photographs taken with a film camera.

## Using the Custom mode

Selecting Custom as the Mode option enables the Custom Settings list, from which you can choose a ready-made setting designed for printing text and graphs. Or, you can select a color-matching method. You can also create and save your own custom settings. For details on making your own custom settings, see “Making Advanced settings” on page 2-12.

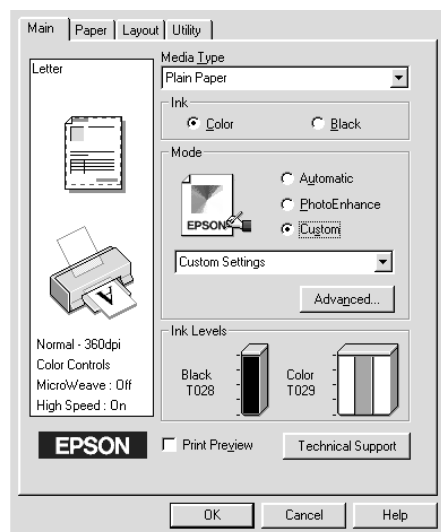

By default, you can choose from the following:

<b>Ready-made setting</b>	<b>Description</b>
Text/Graph	This setting is good for printing presentation documents such as graphs and charts.
Economy	This setting is best for printing drafts of text.
ICM	This method automatically adjusts printout colors to match the colors on your screen. ICM stands for Image Color Matching.
sRGB	This method is best for color matching with other sRGB devices.

When you select a custom setting, other settings such as Print Quality, Halftoning, and Color Adjustment are made automatically. Changes to these settings are reflected in the display at the left side of the Main menu.

Follow the steps below to select a custom setting.

1. Select Custom as the Mode setting on the Main menu.
2. From the Custom Settings list, select the most appropriate setting for the type of document or image that you want to print.
3. Verify the Media Type and Ink settings before printing, as they may be affected by the custom setting that you select. See “Making the Media Type setting” on page 2-3 or “Making the Ink setting” on page 2-15 for details.

## Making Advanced settings

The settings in the Advanced dialog box give you complete control over your printing environment. Use these settings to experiment with new printing ideas or to fine-tune a range of print settings to meet your individual needs. Once you are satisfied with your new settings, you can give them a name and add them to the Custom Settings list on the Main menu.

Follow the instructions in this section to make Advanced settings.

### Note:

*The printer software screens that appear in this procedure are for Windows 98 and 95. The Windows Me and 2000 printer software screens differ slightly in appearance.*

1. Select Custom as the Mode setting on the Main menu and then click Advanced. The Advanced dialog box opens.

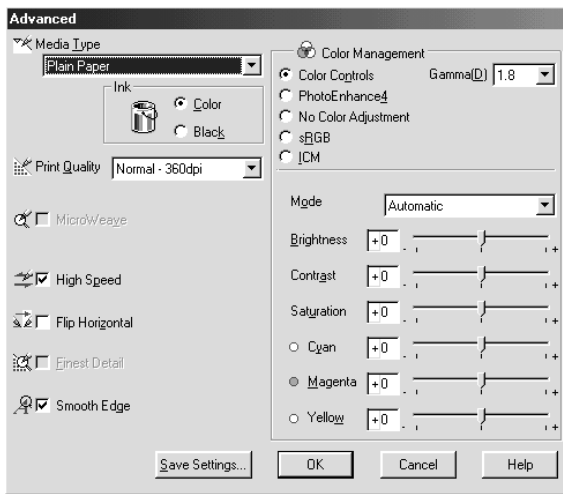

2. Select a Media Type setting that is appropriate for the media loaded in the printer. For details, see "Making the Media Type setting" on page 2-3.
3. Choose Color or Black as the Ink setting.



4. Specify a Print Quality setting.
5. Make other settings as necessary. For details, see online help.

**Note:**

- The PhotoEnhance feature only affects images, not text or graphs. For example, if Monochrome is selected from the Tone list (enabled when PhotoEnhance is selected), only the images in a document will be printed in monochrome. Any colored text or graphs in the same document will be printed in color.*
  - Some settings may be unavailable, depending on the Media Type, Ink, and Print Quality settings that you make.*
6. Click OK to apply your settings and return to the Main menu. To return to the Main menu without applying your settings, click Cancel. To save your Advanced settings, proceed to the next section.

## *Saving and deleting your settings*

To save your Advanced settings in the Custom Settings list, click Save Settings in the Advanced dialog box. The Custom Settings dialog box appears.

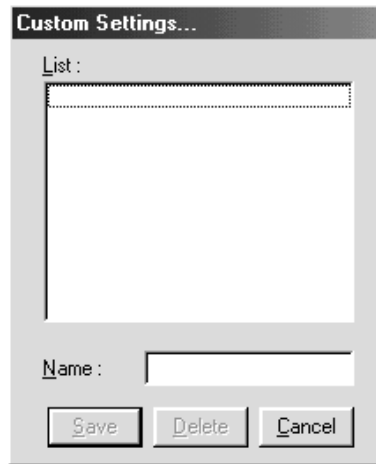

Type a unique name for your settings in the Name text box, then click Save. Your Advanced settings will be added to the Custom Settings list.

### **Note:**

- You cannot apply the names of EPSON ready-made settings or color-matching methods to your custom settings.*
- You cannot delete the ready-made settings or color-matching methods from the Custom Settings list.*

To delete a setting from the Custom Settings list, select it in the Custom Settings dialog box and click Delete.

## *Using your saved settings*

To use your saved settings, select Custom as the Mode setting on the Main menu, then select your settings in the Custom Settings list.

If you change the Media Type or Ink settings while one of your customized settings is selected in the Custom Settings list, the selection shown in the list returns to Custom Settings. The customized setting that was previously selected is not affected by the change. To return to your customized setting, simply reselect it in the list.

### *Making the Ink setting*

To make the Ink setting, click **Color** to print in color, or **Black** to print in black-and-white or grayscale.

## **Previewing your printout**



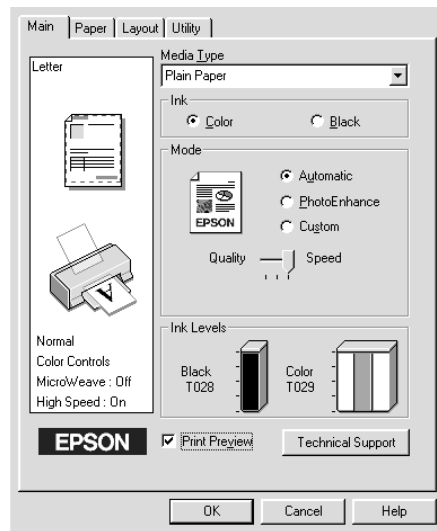

Select the **Print Preview** check box on the **Main** menu when you want to view a preview of your document before printing.

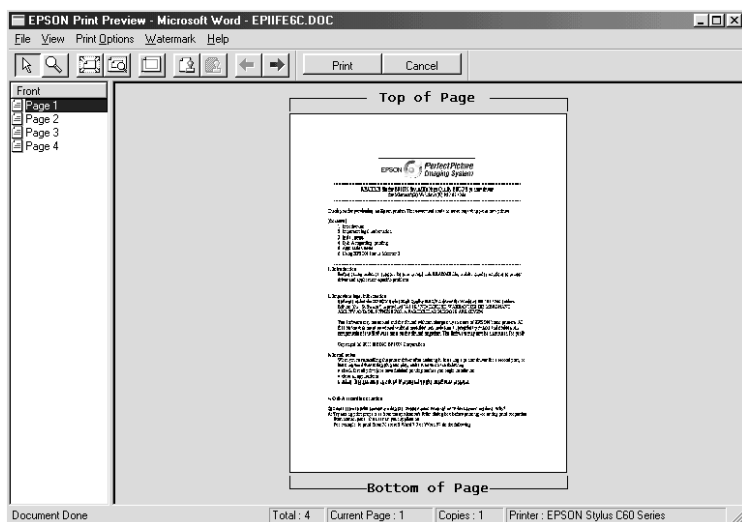





When you send a print job to the printer, the EPSON Print Preview window opens, allowing you to make changes before printing.



The EPSON Print Preview toolbar contains several icon buttons which you can use to perform the following functions.



	Drag 'n' Drop	Click this button to select and move watermarks.
	Zoom	Click this button to enlarge or reduce the size of the previewed page.
	Fit To Screen	Click this button to scale the previewed page so that it fits the size of the window. This is convenient when you want to see the entire page at one time.
	Maximum Zoom	Click this button to display the previewed page at the maximum possible zoom ratio.
	Printable Area On/Off	Click this button to display or hide the borderlines which indicate the printable area. The printer cannot print anything which is outside of this area.

	Watermark	Click this button to open the Watermark Settings dialog box, where you can add watermarks to the document and change any of the current watermark settings.
	Reset Watermark	Click this button to return all watermark settings to what they were when the EPSON Print Preview dialog box was first opened. If no settings have been changed, this feature is not available.
	Previous Page	Click this button to display the page previous to the one currently being previewed. If there is no previous page, this feature is not available.
	Next Page	Click this button to display the next page in the document. If there is no next page, this feature is not available.

You can also manipulate the previewed document in the following ways:

- Select and preview individual pages.
- Reduce or enlarge the size of the preview window.
- Magnify the previewed document. To do this, click **View** and then **Magnify** to open the Magnify window, which magnifies the area of the previewed document that is outlined by the red box. By dragging the red box, you can change which part of the document is magnified.
- View the individual pages that comprise a poster. The Poster window opens automatically when you send a print job while Poster is selected as the Multi-Page option on the **Layout** menu. From this window, you can view the individual pages which make up a poster. You can also open this dialog box by clicking **View** and then **Poster**.

- ❑ Apply watermarks. The watermark that you select will be displayed on the previewed image. For detailed information on customizing watermarks, see “Making Watermark settings” on page 2-24.
- ❑ Specify which pages of the document you would like to print. To add or remove a page, click the page icon in the list at the left side of the preview window, then add or remove it using the commands on the Print Options menu. The Print Options commands are as follows:

	Add page	Click this button to add the highlighted pages to the list of pages to be printed.
	Remove page	Click this button to remove the highlighted pages from the list of pages to be printed.

After you have previewed the document, click Print to print the document, or click Cancel to cancel printing.

---

## Making Settings on the Paper Menu

Use the settings on the Paper menu to change the paper size, set the number of copies and other copy parameters, specify the paper orientation, and adjust the printable area.

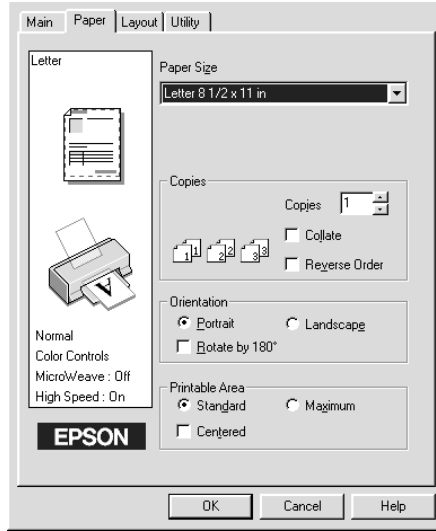

You can make the following settings on the Paper menu:

<b>Paper Size</b>	Select the paper size that you want to use. You can also add a custom paper size.
<b>Copies</b>	Select the number of copies that you want to print. You can select Collate to print one set at a time or Reverse Order to print your documents in reverse order, starting with the last page.
<b>Orientation</b>	Select Portrait (tall) or Landscape (wide) to change the orientation of your printout. To print closer to the bottom of the page, select the Rotate by 180° check box.

<b>Printable Area</b>	Use the options in the Printable Area box to adjust the total area available for printing. To center the printout, select Centered. To increase the printable area, select Maximum.
-----------------------	--

**Note:**

- Do not select Maximum when using Premium Glossy Photo Paper.*
- When Maximum is selected as the Printable Area setting, the print quality may decline at the edges of the printout. Before printing large jobs using this setting, print a single sheet to confirm quality.*
- When Maximum is selected as the Printable Area setting, make sure that the paper loaded in the sheet feeder is not curled.*

---

## **Making Settings on the Layout Menu**

You can make Reduce/Enlarge, Multi-Page, and Watermark settings on the Layout menu. Refer to the appropriate section below.



# Making Reduce/Enlarge settings

Use the Reduce/Enlarge options on the Layout menu to adjust the printed size of your document.

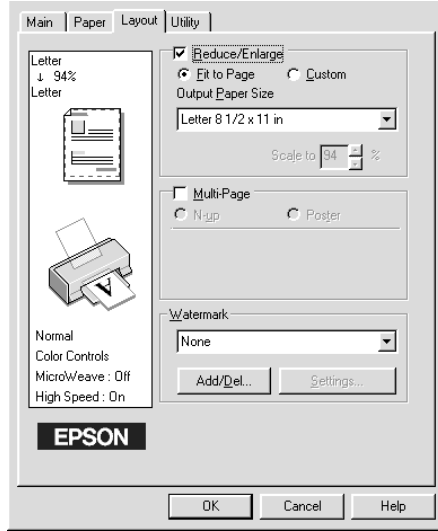

You can select from the following settings.

<b>Fit to Page</b>	Proportionally enlarges or reduces the size of your document to make it fit the paper size selected in the Output Paper Size list.
<b>Custom</b>	Allows you to manually reduce or enlarge an image. Click the arrows next to the Scale to box to select a percentage between 10% and 400%.

# Making Multi-Page settings

Selecting the Multi-Page check box allows you to choose between the N-up and Poster settings. Refer to the appropriate section below.

## Making N-up settings

Select N-up as the Multi-Page setting on the Layout menu to print two or four pages of your document on one sheet of paper.

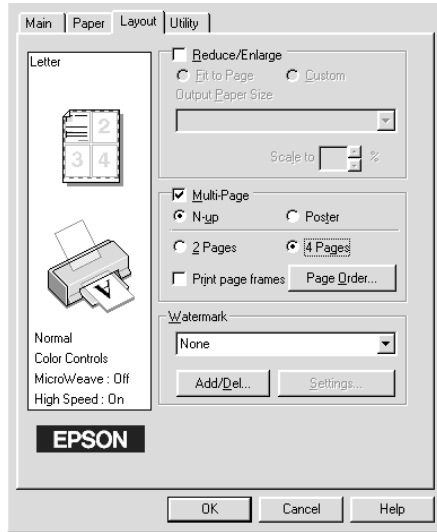

When N-up is selected, you can make the following settings:

<b>2 Pages 4 Pages</b>	Prints two or four pages of your document on a single piece of paper.
<b>Page Order</b>	Opens the Print Layout dialog box, where you can specify the order in which the pages will be printed. Some settings may be unavailable, depending upon the Orientation selection on the Paper menu.
<b>Print page frames</b>	Prints frames around the pages printed on each sheet.

## Making Poster settings

A single document page can be enlarged to cover 4, 9, or 16 printed sheets of paper. Select Poster as the Multi-Page setting to print a poster-size image.

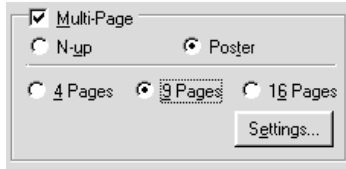

Click the Settings button to adjust the way your poster will print. The Poster Settings dialog box opens.

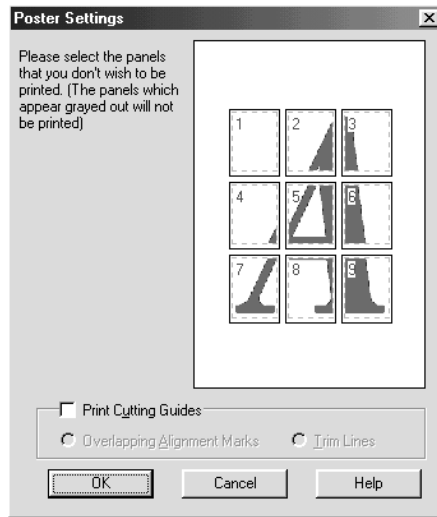

You can make the following settings.

<b>Print Cutting Guides</b>	Check this box to turn the cutting guide options on.
<b>Overlapping Alignment Marks</b>	Slightly overlaps the images and prints alignment markers so that they can be aligned more precisely.

<b>Trim Lines</b>	Prints border lines on the images to guide you when trimming the pages.
-------------------	---

If you only want to print a few of the panels without printing the entire poster, click the panels that you do not wish to print, then click OK to close the Poster Settings dialog box.

## Making Watermark settings

To print a watermark on your document, click anywhere in the Watermark list box on the Layout menu and select a watermark.

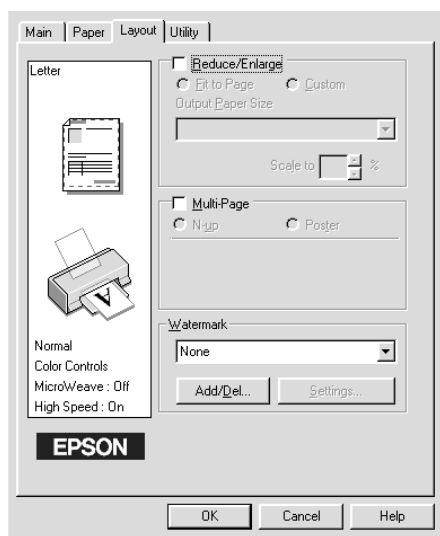

You can also add your own text-based or image-based watermarks to the Watermark list. To add a watermark, click the Add/Del button. The following dialog box appears.

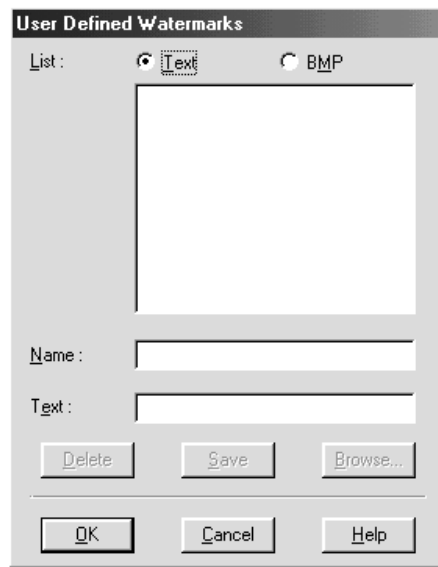

Refer to the appropriate section below to finish creating a custom watermark.

### ***Creating an image-based watermark***

Follow the steps below to create an image-based watermark.

1. Select BMP.
2. Click the Browse button to specify the bitmap file you want to use, then click OK.
3. Type a name for your watermark in the Name box, then click Save. Click OK to return to the Layout menu.

## Creating a text-based watermark

Follow the steps below to create a text-based watermark.

1. Select Text.
2. Type your text in the Text box. The text that you enter will also be used as the watermark name.
3. If you want to change the watermark name, type a new name in the Name box, then click Save. Click OK to return to the Layout menu.

## Adjusting the appearance of watermarks

Follow the steps below to adjust the appearance of watermarks when printed.

1. Select a watermark in the Watermark list box on the Layout menu.
2. Click the Settings button. The following dialog box appears.

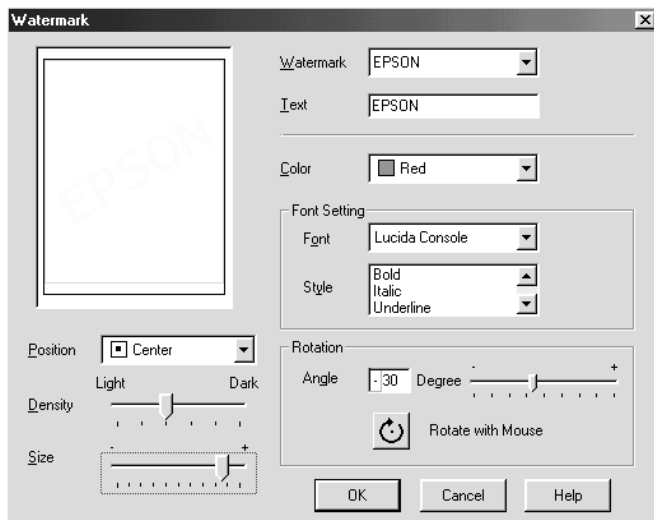

3. Make sure that the appropriate watermark is selected in the Watermark list box, then make Color, Position, Density, Size, Font, Font Style, and Angle settings. (For details, see online help.) Your settings are reflected in the display at the left side of the dialog box.
4. When you are finished making settings, click OK.

---

## Using the Printer Utilities

EPSON printer utilities allow you to check the current printer status and to perform some printer maintenance from your computer.

To use the utilities, click the Utility tab in the printer software, then click the button for the utility that you want to use. For information on how to access the printer software, see “Accessing the printer software” on page 2-2.

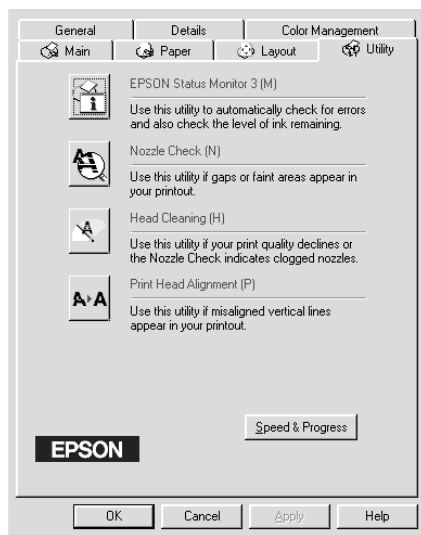

**Note:**

- ❑ *The letter in parentheses after the utility name indicates the shortcut key for that utility. Press Alt and the letter on the keyboard to open that utility.*
- ❑ *Do not use the Nozzle Check, Head Cleaning, or Print Head Alignment utilities if your printer is connected to your computer through a network.*
- ❑ *Do not use the Nozzle Check, Head Cleaning, or Print Head Alignment utilities while printing is in progress; otherwise, your printout may be marred.*

Refer to the appropriate section below.

## **EPSON Status Monitor 3**

Status Monitor 3 provides you with printer status information, such as the amount of ink remaining, and checks for printer errors.

This utility is only available when both of the following conditions are met:

- ❑ The printer is connected directly to the host computer via the parallel or USB port.
- ❑ Your system is configured to support bidirectional communication.

## **Nozzle Check**

The Nozzle Check utility checks the print head nozzles for clogging. Check the nozzles if you notice print quality has declined and after cleaning to confirm that the print head nozzles have been cleared. If the nozzle check indicates the print head needs cleaning, you can access the Head Cleaning utility directly from the Nozzle Check utility. For details, see “Checking the Print Head Nozzles” on page 9-1.



## Head Cleaning

The Head Cleaning utility cleans the print head. You may need to clean the print head if you notice print quality has declined. Use the Nozzle Check utility first to confirm that the print head needs to be cleaned. You can access the Nozzle Check utility directly from the Head Cleaning utility. For details, see “Cleaning the Print Head” on page 9-3.

## Print Head Alignment

The Print Head Alignment utility aligns the print head. If you notice a misalignment of vertical lines in your printouts, use this utility as described below to realign the print head.

When you run the Print Head Alignment utility, the printer prints test patterns that you use to check the print head alignment.

Here are sample printouts.

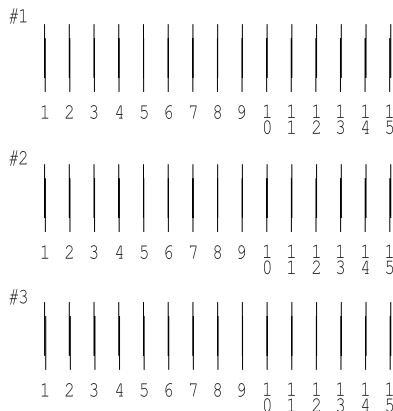

From each pattern on the printed test sheet, choose the vertical line that is aligned best. For each pattern, select the corresponding line number from the appropriate drop-down list box in the Print Head Alignment dialog box, then click Finish to put the new settings into effect.

**Note:**

*If you cannot find a line which is aligned correctly, select the number of the line which is the closest to being correct and click Realignment. The lines you selected will be reset to the center (number 8) position and the alignment test sheet will be printed again.*

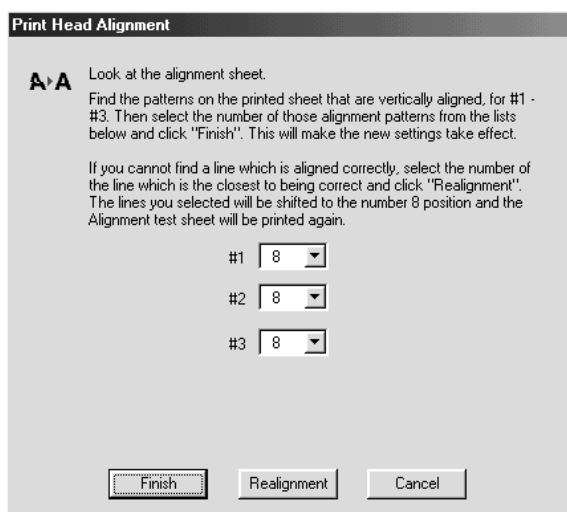

# Speed & Progress

You can make settings related to print speed and progress in this dialog box.

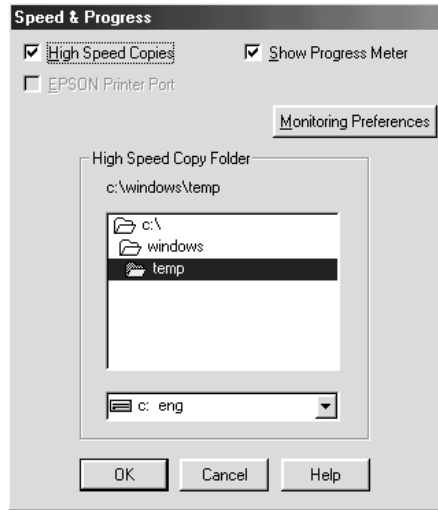

The available settings are as follows:

**Note:**

*The specific features available in the printer software vary depending on the printer model and version of Windows that you are using.*

## High Speed Copies

To print multiple copies of your document faster, select High Speed Copies. This speeds up printing by using your hard disk space as a cache when printing multiple copies of your document.

## Show Progress Meter

To display the Progress Meter every time you print, select Show Progress Meter.

## **EPSON Printer Port**

For printer models that use the parallel port, you can speed up the data transfer rate by selecting EPSON Printer Port.

Parallel port users can further increase print speed by enabling DMA transfer, as explained in “Enabling DMA transfer” on page 7-16.

## **Always spool RAW datatype**

Select this check box to have Windows NT-based clients spool documents using the RAW format instead of the EMF (metafile) format (Windows NT-based applications use the EMF format by default).

Try using this option if documents spooled in EMF format do not print correctly.

Spooling RAW datatype requires less resources than EMF, so some problems (“Insufficient memory/disk space to print”, “Slow print speed”, etc.) can be solved by selecting the Always spool RAW datatype check box.

### **Note:**

*When spooling RAW datatype, print progress as displayed by the Progress Meter may differ from actual print progress.*

## Monitoring Preferences

Click this button to open the Monitoring Preferences dialog box, where you can make settings for EPSON Status Monitor 3.

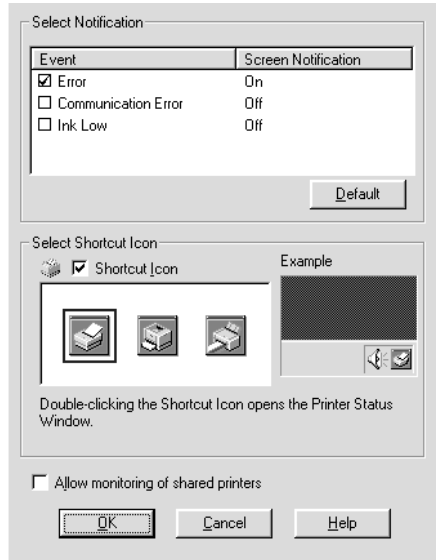

You can make the following settings:

<p><b>Select Notification</b></p>	<p>Displays the current error notification settings. Select the check boxes of the error types for which you want to receive notification.</p> <p><b>Note:</b> Click the Default button to revert all Select Notification settings to their defaults.</p>
<p><b>Select Shortcut Icon</b></p>	<p>Select the Shortcut Icon check box and choose an icon type to have a shortcut icon placed in your Windows taskbar. You can click the shortcut icon in the taskbar to open EPSON Status Monitor 3, or right-click the icon to access some of the printer utilities.</p>
<p><b>Allow monitoring of shared printers</b></p>	<p>Select this check box to allow monitoring of a shared printer by other computers.</p>

---

## **Getting Information Through Online Help**

Your printer software has an extensive online help feature, which provides you with instructions on printing, making printer driver settings, and using printer utilities.

Refer to the appropriate section below.

### **Accessing help from your application**

Open the File menu and choose Print or Print Setup. Then, click Printer, Setup, Options, or Properties. (Depending on your application, you may need to click a combination of these buttons.) Click Help at the bottom of the Main, Paper, Layout, or Utility menu for help related to the items on that menu.

You can get specific help related to any item on a menu by right-clicking the item and then clicking the What's This? command.

### **Accessing help from the Windows Start menu**

Click the Start button, point to Programs and EPSON (for Windows 98 and 95) or EPSON Printers (for Windows Me and 2000), then click EPSON Stylus C60 Series Help. The help contents window opens.

# Checking Printer Status and Managing Print Jobs for Windows

## Using the Progress Meter

When you send a print job to the printer, the Progress Meter opens, as shown in the illustration below.

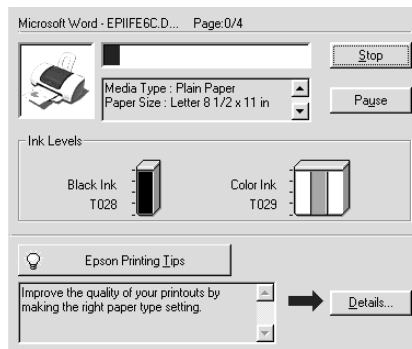

The Progress Meter indicates the progress of the current print job and provides printer status information when bidirectional communication between the printer and computer is established. This meter also displays helpful tips for better printing and error messages. Refer to the appropriate section below.

## Epson Printing Tips

Tips for getting the most out of your EPSON printer software appear in the text box at the bottom of the Progress Meter window. A new tip appears every 30 seconds. For more details on the tip which is currently displayed, click the Details button.

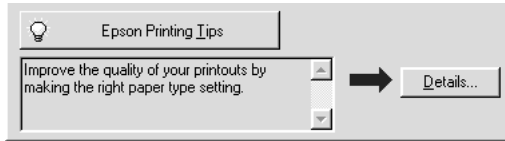

## Error messages

If a problem occurs during printing, an error message appears in the text box at the top of the Progress Meter window. For more detailed information, click Technical Support to access the Problem Solver HTML manual.

When the ink runs low or out, a How to button appears below the text box. Click How To and EPSON Status Monitor 3 will lead you step-by-step through the cartridge replacement procedure.





---

## Using EPSON Spool Manager

EPSON Spool Manager is similar to Windows Print Manager. If it receives two or more print jobs at one time, it holds them in the order that they were received (with printers on a network this may be called a print queue). When a print job reaches the top of the line, the EPSON Spool Manager sends the job to the printer. From the Spool Manager, you can view print status information about the print jobs which have been sent to your printer. You can also cancel, pause, and resume selected print jobs.

**Note:**

*EPSON Spool Manager is not available for Windows 2000.*

After you send a print job, an EPSON Stylus C60 Series Readme button appears on the taskbar. Click this button to open the EPSON Spool Manager.

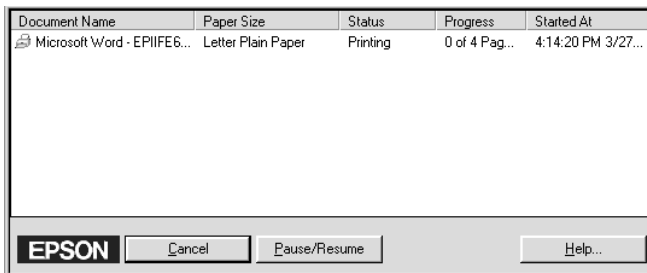

---

## Using EPSON Status Monitor 3

EPSON Status Monitor 3 displays detailed information on the printer status.

**Note:**

*Before using EPSON Status Monitor 3, be sure to read its README file. To open this file, click Start, point to Programs and then to EPSON or EPSON Printers, then click EPSON Stylus C60 Series Readme.*

## Accessing EPSON Status Monitor 3

There are two ways to access EPSON Status Monitor 3:

- ❑ Double-click the printer-shaped shortcut icon on the Windows taskbar. For details on making settings for this icon, see “Monitoring Preferences” on page 2-33.
- ❑ Open the printer software, click the Utility tab, then click the EPSON Status Monitor 3 button.

When you access EPSON Status Monitor 3, the following window appears.

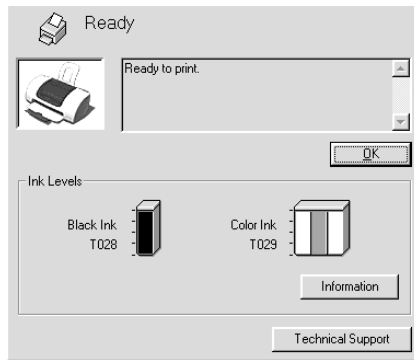

## Viewing information in EPSON Status Monitor 3

EPSON Status Monitor 3 provides the following information.

- ❑ **Current Status:**  
EPSON Status Monitor 3 provides you with detailed printer status information, a graphic display, and status messages. If the ink runs low or out, the How to button appears in the EPSON Status Monitor 3 window. Clicking How to displays ink cartridge replacement instructions and moves the print head to the ink cartridge replacement position.

- ❑ **Ink Levels:**  
EPSON Status Monitor 3 provides a graphic display of the amount of ink remaining, and an estimate of the number of pages that can be printed before ink runs out. For the color ink cartridge, the chamber with the least amount of ink remaining determines the level that is displayed for all of the colors in the cartridge.
  
- ❑ **Ink Cartridge Information:**  
You can view information about the installed ink cartridges by clicking the Information icon.
  
- ❑ **Technical Support**  
You can access the Problem Solver HTML manual from EPSON Status Monitor 3. If you encounter a problem, click Technical Support in the EPSON Status Monitor 3 window.





## Printer Software Introduction

The printer software which comes with your printer includes a printer driver and printer utilities. The printer driver lets you choose from a wide variety of settings to get the best results from your printer. The printer utilities help you check the printer and keep it in top operating condition.



The printer driver settings and utilities appear in the following dialog boxes.

Dialog Box	Settings and Utilities
Print	Media Type, Mode, Copies, Pages, Ink
Page Setup	Paper Size, Orientation, Rotate by 180 degrees, Reduce or Enlarge, Printable Area
Layout	Fit to Page, Watermark, Multi-Page, Print Order
Utility	EPSON Status Monitor 3, Nozzle Check, Head Cleaning, Print Head Alignment, Configuration (dialog box)

These dialog boxes can be accessed as described below.

Dialog Box	How to Access
Print	Click Print on the File menu of your application or click Options in the Page Setup dialog box.
Page Setup	Click Page Setup on the File menu of your application
Layout	Click the  Layout icon button in the Print dialog box
Utility	Click the  Utility icon button in the Print or Page Setup dialog box

In addition, you can access the dialog boxes below from the Print dialog box.

<b>Dialog Box</b>	<b>How to Access</b>
Background Printing	Click the  Background Printing icon button in the Print dialog box
Preview	Click the  Preview icon button in the Print dialog box and then click Preview
Save File	Click the  Preview icon button in the Print dialog box until the Print button changes into the Save File button and then click the Save File button.

In addition to the printer software information in this guide, you can get more details by clicking the help icon in any of the dialog boxes in the printer software.

If you encounter any problems when using the printer software, refer to the EPSON Technical Support Web Site. To access the Web site from the printer software CD-ROM, insert the CD in the CD-ROM drive and double-click the Technical Support Web Site icon in the EPSON folder.

---

## ***Making Settings in the Print Dialog Box***

You can make Media Type, Mode, Ink, Copies, and Pages settings in the Print dialog box. From this dialog box, you can also access other dialog boxes, from which you can set the print time, preview the document before printing, and save spool data as a file. Refer to the appropriate section below.

### ***Making the Media Type setting***

The Media Type setting determines what other settings are available, so you should always make this setting first.

In the Print dialog box, select the Media Type setting that matches the paper that is loaded in the printer. To find out what media type you are using, find your media in the list below, and refer to the corresponding media type under which it is grouped (shown in larger type). For some media, there are several Media Type settings from which to choose.

## **Plain Paper**

Plain paper

Envelopes

EPSON Premium Ink Jet Plain Paper (A4) S041214

EPSON Bright White Ink Jet Paper (A4) S041442

## **360 dpi Ink Jet Paper**

EPSON 360 dpi Ink Jet Paper (A4) S041059

S041025

EPSON 360 dpi Ink Jet Paper (Letter) S041060

S041028

EPSON Iron-On Cool Peel Transfer Paper (A4) S041154

EPSON Iron-On Cool Peel Transfer Paper (Letter) S041153

S041155



## **Photo Quality Ink Jet Paper**

EPSON Photo Quality Ink Jet Paper (A4)	S041061 S041026
EPSON Photo Quality Ink Jet Paper (Letter)	S041062 S041029
EPSON Photo Quality Ink Jet Paper (Legal)	S041067 S041048
EPSON Photo Quality Ink Jet Card (A6)	S041054
EPSON Photo Quality Ink Jet Card (5 × 8")	S041121
EPSON Photo Quality Ink Jet Card (8 × 10")	S041122
EPSON Photo Quality Self Adhesive Sheet (A4)	S041106
EPSON Ink Jet Note Cards A6 (with envelopes)	S041147
EPSON Ink Jet Greeting Cards 5 × 8" (with envelopes)	S041148
EPSON Ink Jet Greeting Cards 8 × 10" (with envelopes)	S041149

## **Matte Paper-Heavyweight**

EPSON Matte Paper-Heavyweight (A4)	S041256 S041258 S041259
EPSON Matte Paper-Heavyweight (Letter)	S041257

## **Photo Paper**

EPSON Photo Paper (A4)	S041140
EPSON Photo Paper (Letter)	S041141
EPSON Photo Paper (4 × 6")	S041134
EPSON Photo Paper (100 × 150 mm)	S041255
EPSON Photo Paper (200 × 300 mm)	S041254
EPSON Panoramic Photo Paper (210 × 594 mm)	S041145
EPSON Photo Paper Cards (A4)	S041177

## **Photo Quality Glossy Film**

EPSON Photo Quality Glossy Film (A4)	S041071
EPSON Photo Quality Glossy Film (Letter)	S041072
EPSON Photo Quality Glossy Film (A6)	S041107
EPSON Photo Stickers 16 (A6)	S041144
EPSON Photo Stickers 4 (A6)	S041176

## **Ink Jet Transparencies**

EPSON Ink Jet Transparencies (A4)	S041063
EPSON Ink Jet Transparencies (Letter)	S041064

## **Premium Glossy Photo Paper**

EPSON Premium Glossy Photo Paper (A4)	S041287 S041297
EPSON Premium Glossy Photo Paper (Letter)	S041286
EPSON Premium Semigloss Photo Paper (A4)	S041332
EPSON Premium Semigloss Photo Paper (Letter)	S041331

### **Note:**

*The availability of special media varies by location. For the latest*

information on media available in your area, contact EPSON customer services. See “Regional Customer Services” on page B-1 for details.

## Making the Mode setting

The Mode settings in the Print dialog box give you three levels of control over the printer software, as explained below:

<b>Automatic</b>	This mode provides the quickest and easiest way to start printing. See “Using the Automatic mode” on page 4-8 for details.
<b>PhotoEnhance</b>	This mode lets you choose from a variety of image-correction settings specially designed for photos. See “Using the PhotoEnhance mode” on page 4-8 for details.
<b>Custom</b>	This mode lets you choose from a list of ready-made or personalized settings suited to the kind of document that you want to print. When Custom is selected, the Advanced button is enabled, allowing you to access the Advanced dialog box. See “Using the Custom mode” on page 4-10 for details.

In addition to making comprehensive Mode settings that affect overall print quality, you can also modify individual aspects of your printout using the settings contained in the Page Setup and Layout dialog boxes. See “Making Settings in the Page Setup Dialog Box” on page 4-17 or “Making Settings in the Layout Dialog Box” on page 4-21 for details.

## Using the Automatic mode

When Automatic is selected as the Mode setting in the Print dialog box, the printer software takes care of all detailed settings based on the current Media Type and Ink settings. To make the Ink setting, see “Making the Ink setting” on page 4-14. To make the Media Type setting, see “Making the Media Type setting” on page 4-2.

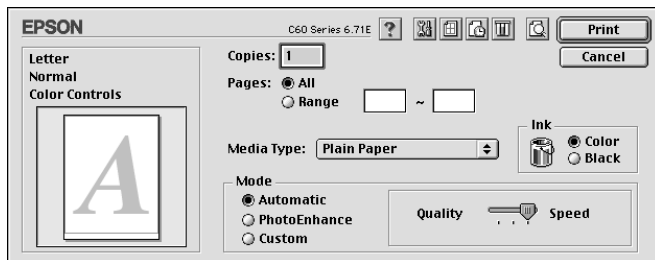

### Note:

*Depending on the media selected in the Media Type list (while Automatic is selected), a slider appears to the right of the Mode options that lets you choose Quality or Speed. Select Quality when print quality is more important than speed.*

## Using the PhotoEnhance mode

The PhotoEnhance mode provides a variety of image-correction settings that you can apply to your photos before printing. PhotoEnhance does not affect your original data.

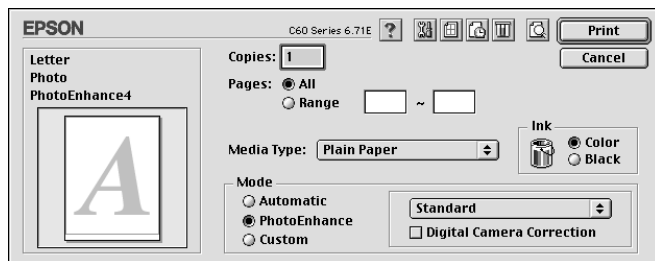

**Note:**

- This mode is only available when printing 32-bit color data.*
  
- Printing with PhotoEnhance selected may increase the time required for printing, depending on your computer system and the amount of data contained in your image.*

You can select from the following settings.

<b>Standard</b>	This setting provides standard image correction for most photos. Try this first.
<b>People</b>	This setting is best for photos of people.
<b>Nature</b>	This setting is best for outdoor scenery such as mountains, skies, and oceans.
<b>Soft Focus</b>	This setting makes your photos look as if they were taken with a soft-focus lens.
<b>Sepia</b>	This setting applies a sepia tone to your photos.

Selecting PhotoEnhance also enables the Digital Camera Correction check box. Select this check box when you are printing photos taken with a digital camera to give your printed images the smooth, natural appearance of photographs taken with a film camera.

## Using the Custom mode

Selecting Custom as the Mode option enables the Custom Settings list, from which you can choose a ready-made setting designed for printing text and graphs. Or, you can select ColorSync, a color-matching method. You can also create and save your own custom settings. For details on making your own custom settings see “Making Advanced settings” on page 4-11.

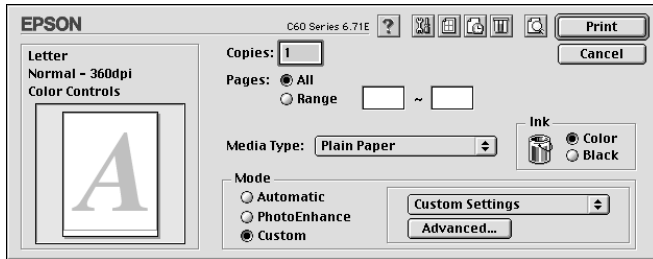

You can select from the following ready-made settings.

<b>Text/Graph</b>	This setting is good for printing presentation documents such as graphs and charts.
<b>Economy</b>	This setting is best for printing drafts of text.
<b>ColorSync</b>	This setting automatically adjusts printout colors to match colors on your screen.

When you select a custom setting, other settings such as Print Quality, Halftoning, and Color Management are made automatically. Changes to these settings are reflected in the display at the left side of the Print dialog box.

Follow the steps below to select a custom setting.

1. Select Custom as the Mode setting in the Print dialog box. This enables the Custom Settings list, located to the right of the Custom radio button.

2. From the Custom Settings list, select the most appropriate setting for the type of document or image that you want to print.
3. Confirm that the Media Type and Ink settings in the Print dialog box are correct. For details, see “Making the Ink setting” on page 4-14 or “Making the Media Type setting” on page 4-2.

### Making Advanced settings

The settings in the Advanced dialog box give you complete control over your printing environment. Use these settings to experiment with new printing ideas or to fine-tune a range of print settings to meet your individual needs. Once you are satisfied with your new settings, you can give them a name and add them to the Custom Settings list in the Print dialog box.

Follow the instructions below to make Advanced settings.

1. Select Custom as the Mode setting in the Print dialog box and then click Advanced. The Advanced dialog box opens.

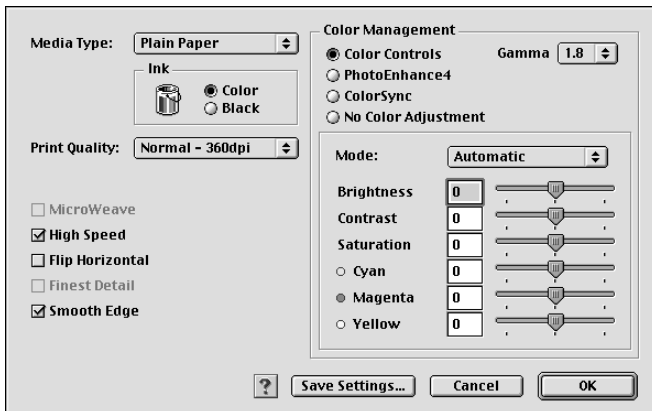

2. Select a Media Type setting that is appropriate for the media loaded in the printer. For details, see “Making the Media Type setting” on page 4-2.
3. Choose Color or Black as the Ink setting.
4. Specify a Print Quality setting.
5. Make other settings as necessary. For details, see online help.

**Note:**

- ❑ *The PhotoEnhance feature only affects images, not text or graphs. For example, if Monochrome is selected from the Tone list (enabled when PhotoEnhance is selected), only the images in a document will be printed in monochrome. Any colored text or graphs in the same document will be printed in color.*
  - ❑ *Some settings may be unavailable, depending on the Media Type, Ink, and Print Quality settings that you make.*
6. Click OK to apply your settings and return to the Print dialog box. To return to the Main menu without applying your settings, click Cancel. To save your Advanced settings, proceed to the next section.

### Saving and deleting your settings

To save your Advanced settings in the Custom Settings list, click Save Settings in the Advanced dialog box. The Custom Settings dialog box appears.





Type a unique name (up to 16 characters) for your settings in the Name text box, then click **SAVE**. Your Advanced settings will be added to the Custom Settings list. You can save up to 10 different custom settings.

**Note:**

- You cannot apply the names of EPSON ready-made settings or color-matching methods to your custom settings.*
  
- You cannot delete the ready-made settings or color-matching methods from the Custom Settings list.*

To delete a setting from the Custom Settings list, select it in the Custom Settings dialog box and click **Delete**.

### *Using your saved settings*

To use your saved settings, select **Custom** as the Mode setting in the Print dialog box, then select your setting in the Custom Settings list.

If you change the Media Type or Ink settings while one of your customized settings is selected in the Custom Settings list, the selection shown in the list returns to Custom Settings. The customized setting that was previously selected is not affected by the change. To return to your customized setting, simply reselect it in the list.

### *Making the Copies setting*

To make the Copies setting, enter the number of copies that you want to print in the Copies text box.

### *Making the Pages setting*

To make the Pages setting, select either **All** or **Range**. If you select **Range**, enter the appropriate range of pages in the Range text boxes.

## Making the Ink setting

To make the Ink setting, click Color to print in color, or Black to print in black-and-white or grayscale.

## Setting the print time

You can specify the time that you want the printer to begin printing your document. Follow the steps below.

1. Click the  Background Printing icon button in the Print dialog box. The Background Printing dialog box opens.

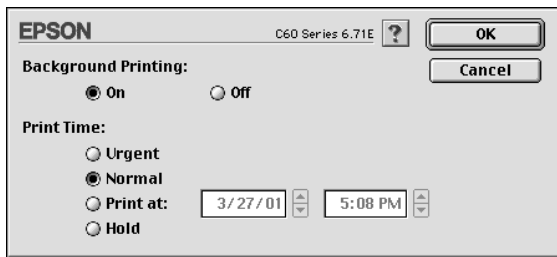

2. Select On as the Background Printing option, if necessary.
3. Select Urgent, Normal, Print at, or Hold as the Print Time option.

If you select Print at, use the arrows beside the date and time boxes to specify the date and time that you want to print the document.

**Note:**

*Make sure that the computer and printer are turned on at the date and time you specify.*

4. Click OK. The Background Printing dialog box closes.
5. In the Print dialog box, make sure that your print settings are as you want them, then click Print.

**Note:**





You can check or change the priority of print jobs using the EPSON Monitor3 utility. See “Using EPSON Monitor3” on page 5-4 for details.

## Previewing your printout

The Preview feature allows you to see how your document will look before actually printing it. Follow these steps to preview your document.

1. Make your printer driver settings.
2. Click the  Preview icon button in the Print dialog box. The Print button changes into a Preview button.





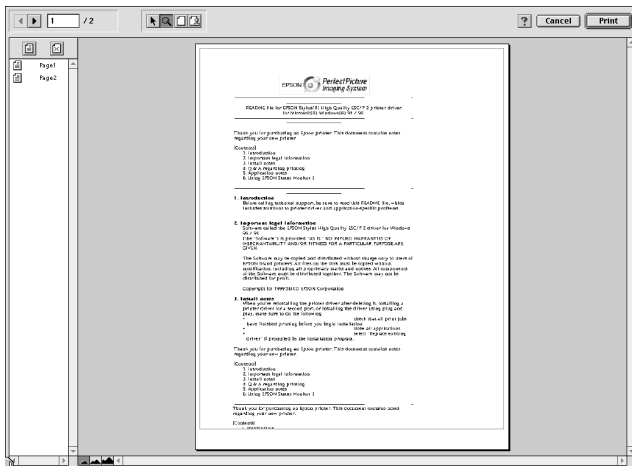

**Note:**

Use the  Preview icon button to toggle between the  Print,  Preview, and  Save File modes. Click the icon button to select the mode that you want. For information on the Save File mode, see “Saving spool data as a file” on page 4-16.

3. Click the Preview button. The Preview dialog box opens and displays a preview of your document.



The Preview dialog box contains several icon buttons that you can use to perform the following functions.

	Edit Watermark	Click this button to select, move, and resize watermarks.
	Zoom	Click this button to enlarge or reduce the size of the previewed page.
	Show/Hide Printable Area	Click this button to display or hide the borderlines which indicate the printable area. The printer cannot print anything which is outside of this area.
	Show/Hide Watermark Settings	Click this button to open the Watermark Edit dialog box, where you can add watermarks to the document and change any of the current watermark settings.
	Add page	Click these buttons to add or remove selected pages from the list of pages to be printed.
	Remove page	





4. If you are satisfied with the previewed image, click Print.

If you are not satisfied with the appearance of the image, click Cancel. The Preview and Print dialog boxes close with the current print settings preserved. Open the Print dialog box again to make additional changes to the print settings.

## ***Saving spool data as a file***

You can save spool data as a file using the  Save File icon button in the Print dialog box. This feature lets you use the saved spool data to print the document at a later time simply by double-clicking the saved file. Follow the steps below.

**Note:**

Use the  Preview icon button to toggle between the  Print,  Preview, and  Save File modes. Click the icon button to select the mode you want.

1. Make your printer driver settings.
2. Click the  Preview icon button in the Print dialog box repeatedly until the Print button changes into the Save File button.
3. Click the Save File button. The following dialog box appears.

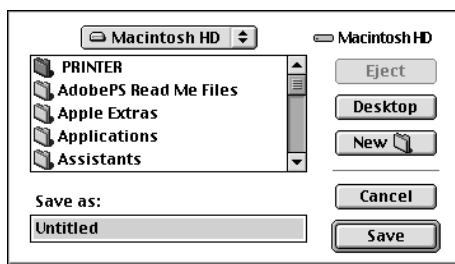

4. Select the location where you want to save the file, then type a file name in the Save As text box and click Save.
5. When you want to print the document, double-click the file to open EPSON Monitor3, make sure that the correct document is selected, then click the  Resume button to send the data to the printer.

---

## **Making Settings in the Page Setup Dialog Box**

In the Page Setup dialog box, you can change the paper size, specify the paper orientation, rotate your document by 180 degrees, reduce or enlarge your printout, and adjust the printable area.

Choose Page Setup from the File menu of your application. The Page Setup dialog box appears.

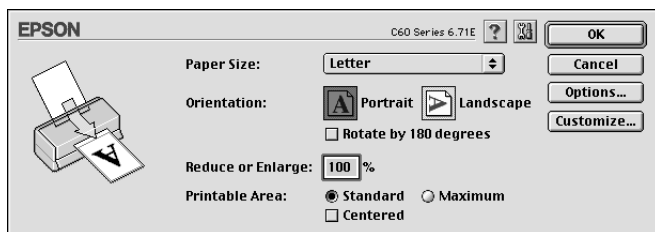

You can make the following settings in the Page Setup dialog box.

<b>Paper Size</b>	Select the paper size that you want to use. If you want to define a custom paper size, see "Defining a custom paper size" on page 4-19.
<b>Orientation</b>	Select Portrait (tall) or Landscape (wide) to change the orientation of your printout. To print close to the bottom of the page, select the Rotate by 180 degrees check box.
<b>Reduce or Enlarge</b>	Use this setting to reduce or enlarge the size of your image from 25% to 400%.
<b>Printable Area</b>	<p>Use the options in the Printable Area box to adjust the total area available for printing when Sheet Feeder is selected as the Paper Source setting.</p> <p>To center the printout, select Centered. To increase the printable area, select Maximum. Do not select Maximum while using Premium Glossy Photo Paper.</p> <p><b>Note:</b> The print quality may decline at the edges of the printout when Maximum is selected as the Printable Area setting. Before printing large jobs using this setting, print a single sheet to confirm quality. When Maximum is selected, make sure that the paper loaded in the sheet feeder is not curled.</p>

## Defining a custom paper size

You can define a custom paper size. To do so, you can either create a new paper size, or base your custom paper size on a pre-existing paper size. Refer to the appropriate section below.

### Creating a new paper size

If the appropriate paper size is not included in the Paper Size list in the Page Setup dialog box, follow the steps below to define a new custom paper size.

1. In the Page Setup dialog box, click **Customize**. The following dialog box appears.

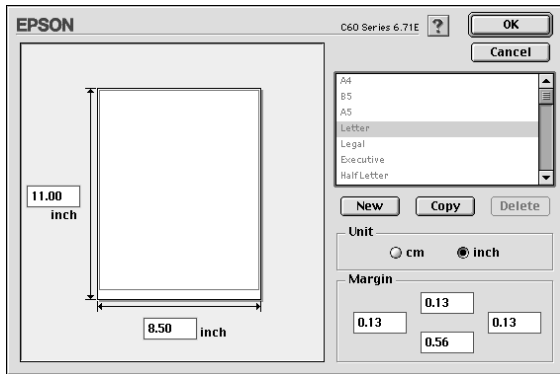

2. To define a new paper size, click New. The dialog box updates to allow you to enter a name for the new size.

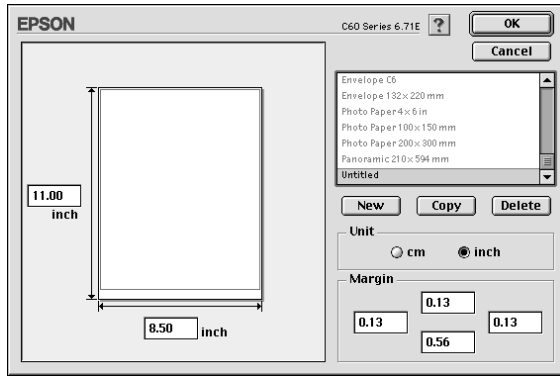

3. Type a unique name for the paper size in the Paper Size list.
4. Specify the measurement unit as either inch or cm.
5. Enter the width and the height of your paper by typing the text in the appropriate box.
6. Specify the margins by typing in the Margin input boxes or by manipulating the preview image.
7. Click OK. You return to the Page Setup dialog box.

You can define up to 100 paper sizes. The paper size names you create will appear in the Paper Size list in the Page Setup dialog box.

To delete a custom paper size, click Customize in the Page Setup dialog box, select the paper size from the list in the Custom Paper dialog box, and click Delete.

### ***Copying a pre-existing paper size to use as a template***

Follow the steps below to copy an existing paper size to use as a template.



1. Select the existing paper size to copy and click Copy.
2. Specify the measurement unit as either inch or cm.
3. Specify the margins by typing in the Margin input boxes or by manipulating the preview image.
4. Click OK.

---

## Making Settings in the Layout Dialog Box

You can modify the page layout of your document using the printer driver settings located in the Layout dialog box. To open this dialog box, click Print on the File menu of your application, then click the  Layout icon button in the Print dialog box.

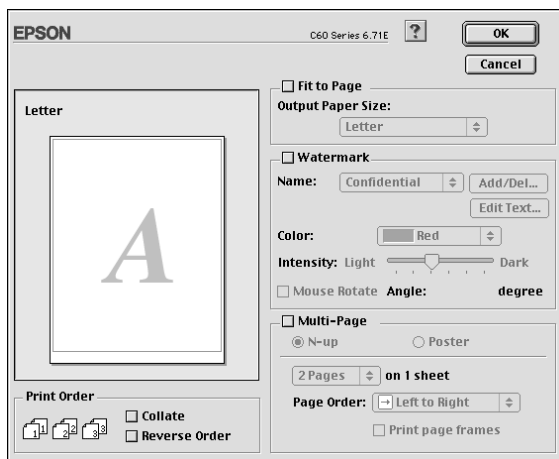

The Layout dialog box allows you to automatically match the document size to the paper size, print two or four pages on a single sheet of paper, print poster-size images by enlarging one page to cover several sheets, place watermarks on documents, or specify the printing order for your print job. Refer to the appropriate section below.

## Making the Fit to Page setting

You can proportionally enlarge or reduce the size of the image to make it fit a selected paper size. To do this, select the Fit to Page check box, then select the paper size in the Output Paper Size list.

## Making Watermark settings

To print a watermark on your document, select the Watermark check box in the Page Layout dialog box.

Select the watermark that you want to print from the Name list, then specify its position, size, color, and intensity. You can change the position and size of the watermark by dragging it with your mouse in the preview window at the left.

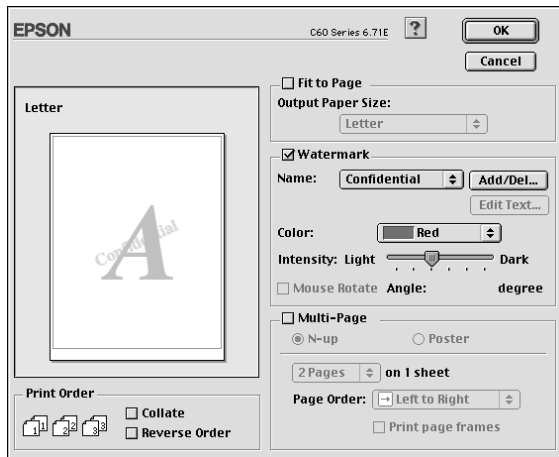

You can also add your own text-based or image-based watermarks to the Name list. Follow these steps.

1. Click the Add/Del button beside the Name list. The following dialog box appears.



2. To use an image file as a watermark, click the Add PICT button. Specify the desired image file, then click Open.

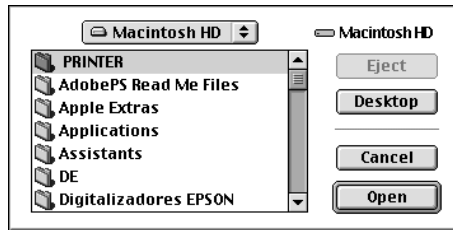

To create a text-based watermark, click the Add Text button. Type the text in the Text box, select a font and a text style, then click OK.

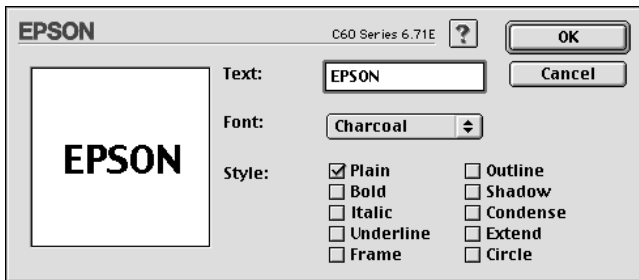

3. The image file name or the watermark text appears in the Mark Name list in the Watermark dialog box. To change the name of an image watermark, click it in the list, then type a new name. When a text watermark is selected in the Name list, you can edit the text or change the font and text style by clicking the Edit Text button.



4. Click OK to add your watermark to the Name list in the Page Layout dialog box.

## **Making Multi-Page settings**

Selecting the Multi-Page check box allows you to choose between the N-up and Poster settings. Refer to the appropriate section below.

## Making N-up settings

Select N-up as the Multi-Page setting in the Layout dialog box to print two or four pages of your document on one sheet of paper.

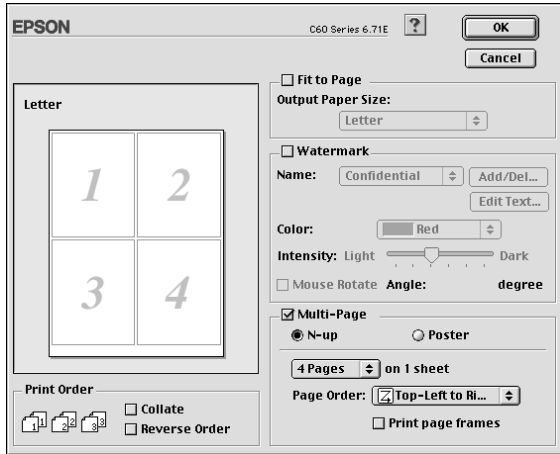

When N-up is selected, you can make the following settings:

<b>2 Pages 4 Pages</b>	Prints two or four pages of your document on a single piece of paper.
<b>Page Order</b>	Allows you to specify the order in which the pages will be printed on the sheet of paper.
<b>Print page frames</b>	Prints frames around the pages printed on each sheet.

## Making Poster settings

A single document page can be enlarged to cover 4, 9, or 16 printed sheets of paper. Select Poster as the Multi-Page setting to print a poster-size image.

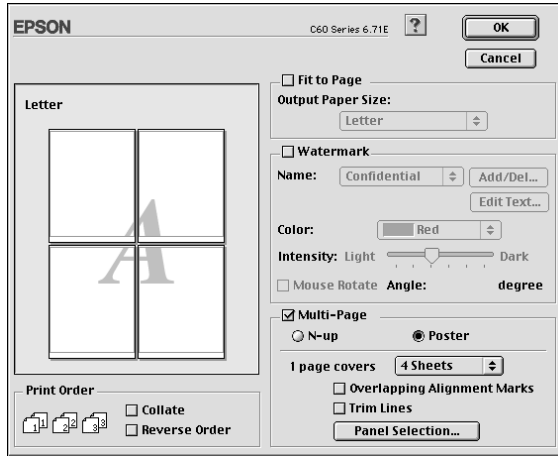

You can make the following settings.

<b>1 page covers xx sheets</b>	Specifies how many printed sheets of paper the enlarged document page is to cover. You can select 4, 9, or 16 pages.
<b>Overlapping Alignment Marks</b>	Slightly overlaps the images and prints alignment markers so that they can be aligned more precisely.
<b>Trim Lines</b>	Prints border lines on the images to guide you when trimming the pages.
<b>Panel Selection</b>	Click the panels you do not need to print, then click the OK button to print the remaining panels.

If you only want to print a few of the panels without printing the entire poster, click Panel Selection, then click the panels that you do not wish to print, and then click OK. Only the panels that you did not click will be printed.

# Making Print Order settings

You can specify the printing order for your print job. When printing multiple copies of your document, select Collate to print one complete document set at a time. Select Reverse Order to print your documents in reverse order, starting with the last page.

---

## Using the Printer Utilities

EPSON printer utilities allow you to check the current printer status and to perform printer maintenance from your computer.

To use the utilities, click the  Utility icon button in the Print or Page Setup dialog box, then click the button for the utility that you want to use.

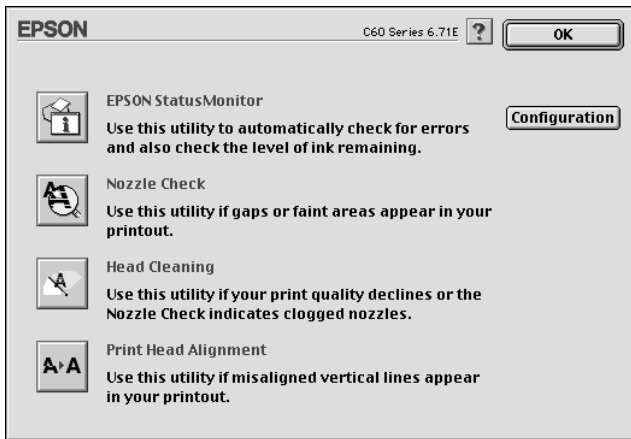

**Note:**

*Do not use the Nozzle Check, Head Cleaning, or Print Head Alignment utilities while printing is in progress; otherwise, your printout may be marred.*

Refer to the appropriate section below.

## **EPSON StatusMonitor**

The StatusMonitor utility monitors the printer status. If it detects a printer error, it will inform you with an error message.

You can also use this utility to check how much ink is remaining before printing.

To use the StatusMonitor, click the EPSON StatusMonitor button in the Utility dialog box. For details, see “Using EPSON StatusMonitor” on page 5-1.

## **Nozzle Check**

The Nozzle Check utility checks the print head nozzles for clogging. Check the nozzles if you notice print quality has declined and after cleaning to confirm that the print head nozzles have been cleared. If the nozzle check indicates the print head needs cleaning, you can access the Head Cleaning utility directly from the Nozzle Check utility. For details, see “Checking the Print Head Nozzles” on page 9-1.

## **Head Cleaning**

The Head Cleaning utility cleans the print head. You may need to clean the print head if you notice print quality has declined. Use the Nozzle Check utility first to confirm that the print head needs to be cleaned. For details, see “Cleaning the Print Head” on page 9-3.

## **Print Head Alignment**

The Print Head Alignment utility aligns the print head. Use this utility if you notice a misalignment of vertical or horizontal lines. Follow the on-screen instructions to use this utility.



When you run the Print Head Alignment utility, the printer prints test patterns that you use to check the print head alignment.

Here are sample printouts.

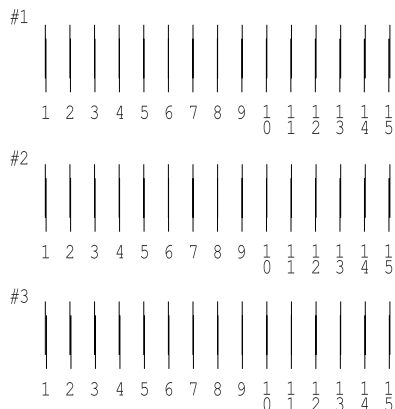

From each pattern on the printed test sheet, choose the vertical line that is aligned best. For each pattern, select the corresponding line number from the appropriate drop-down list box in the Print Head Alignment dialog box, then click Finish to put the new settings into effect.

**Note:**

*If you cannot find a line which is aligned correctly, select the number of the line which is the closest to being correct and click Realignment. The lines you selected will be reset to the center (number 8) position and the alignment test sheet will be printed again.*

## Configuration

Click this button to open the Configuration dialog box, where you can change the method by which the StatusMonitor utility notifies you when the printer status changes. For details, see "Using the Configuration Settings dialog box" on page 5-2.

---

## **Getting Information Through Online Help**

Your printer software has an extensive online help feature, which provides you with instructions on printing, making printer driver settings, and using the printer utilities.

To access online help, choose Print or Page Setup from the File menu of your application. Then, click the  Help icon button.

---

# Checking Printer Status and Managing Print Jobs for Macintosh

---

## Using EPSON StatusMonitor

EPSON StatusMonitor monitors the printer. If it detects a printer error, it will inform you with an error message.

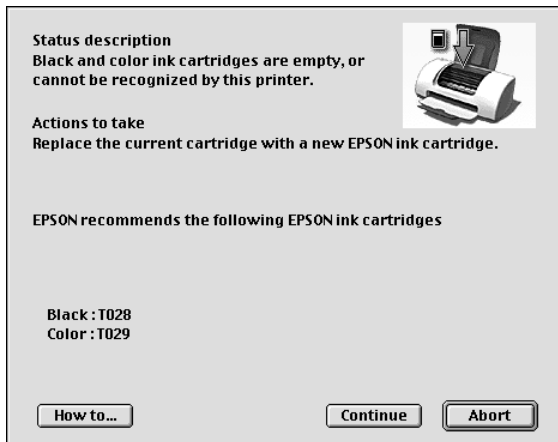

When the ink runs low or out, a How to button appears. Click How to and EPSON StatusMonitor will lead you step-by-step through the ink cartridge replacement procedure.



You can also use this utility to check ink levels before printing. When open, EPSON StatusMonitor displays the amount of ink remaining at the time it was opened. To update the ink level information, click the Update button.

## Accessing EPSON StatusMonitor

Follow the steps below to access EPSON StatusMonitor.

1. Click Print or Page Setup on the File menu of your application. The Print dialog box opens.
2. Click the  StatusMonitor icon button or click the  Utility icon button and then the EPSON StatusMonitor button in the Utility dialog box. The StatusMonitor dialog box opens.

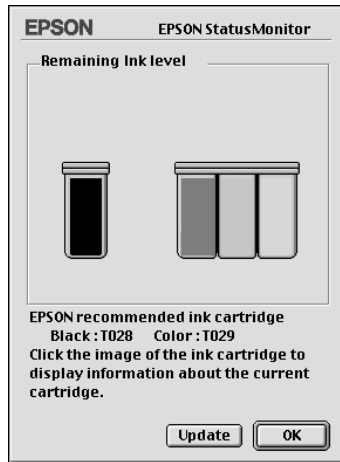

## Using the Configuration Settings dialog box

To change the way that the StatusMonitor utility monitors your printer, or to change the way that your printer handles print jobs, follow the steps below.

1. Click Print or Page Setup on the File menu of your application.
2. Click the  Utility icon button.

- Click the Configuration button. The Configuration Settings dialog box appears.

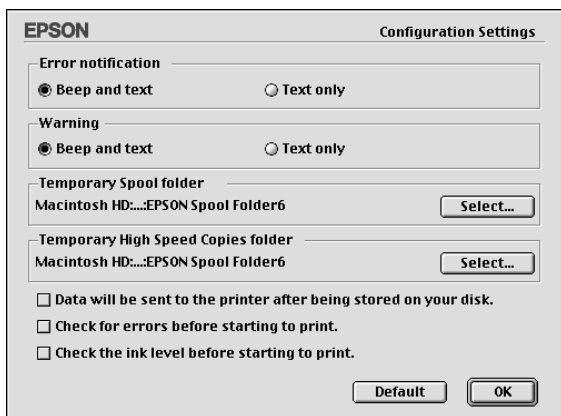

In the Configuration Settings dialog box, you can make the following settings:

<b>Error notification</b>	Choose the method by which EPSON StatusMonitor will notify you in case of an error.
<b>Warning</b>	Choose the method by which EPSON StatusMonitor will notify you if a warning message becomes necessary.
<b>Temporary Spool folder</b>	Specify the folder in which print data will be temporarily spooled.
<b>Temporary High Speed Copies folder</b>	Specify the folder in which multiple-copy print data will be temporarily stored.
<b>Data will be sent to the printer after being stored on your disk.</b>	Select this check box to prevent horizontal banding in printouts that contain images by having the computer temporarily store image data on its hard drive. The computer will then send the image data to the printer as a whole rather than as rectangular bands.
<b>Check for errors before starting to print.</b>	Select this check box to have the printer check for errors before starting to print.

**Check the ink level before starting to print.**

Select this check box to have the printer check the ink levels before starting to print.

---

## Using EPSON Monitor3

After you send a print job to the printer, you can use the EPSON Monitor3 utility to check, cancel, or change the priority of print jobs that are queued for printing. This utility also shows the status of the job currently being printed.

## Accessing EPSON Monitor3

To access EPSON Monitor3, follow these steps.

1. First, turn on Background Printing in the Chooser or in the Background Printing dialog box.
2. Send a print job to the printer.
3. Select EPSON Monitor3 from the Application menu at the right end of the menu bar. The EPSON Monitor3 dialog box opens.

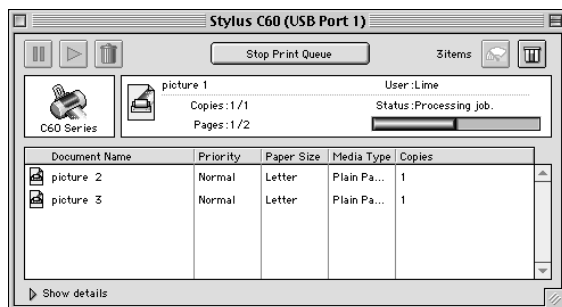



**Note:**

You can also open EPSON Monitor3 by double-clicking the EPSON Monitor3 icon in the Extensions folder.



## Managing print jobs using EPSON Monitor3

Using EPSON Monitor3, you can manage print jobs as described below:

- ❑ Use the buttons below to hold, resume, and delete print jobs. Select the print job that you want to manage, then click the appropriate button.

	Hold	Pauses printing and keeps the current print job at the top of the print queue
	Resume	Resumes printing
	Delete	Stops printing and deletes the print job from the print queue

- ❑ Click Stop Print Queue to stop printing. Click Start Print Queue to resume printing.
- ❑ Use the buttons below to start the printer utilities.

	Print head cleaning	Starts the Print Head Cleaning utility
	StatusMonit or	Starts EPSON StatusMonitor, which displays the amount of ink remaining

- ❑ Double-click a file in the list to preview it (this function is disabled when you are printing the ESC/P command file).
- ❑ Double-click Copies to change the number of copies of the selected print job that will be printed.

- ❑ Click the Show details arrow to open an extension at the bottom of the EPSON Monitor3 dialog box similar to the one below. The extension displays detailed information on the selected document's printer software settings.

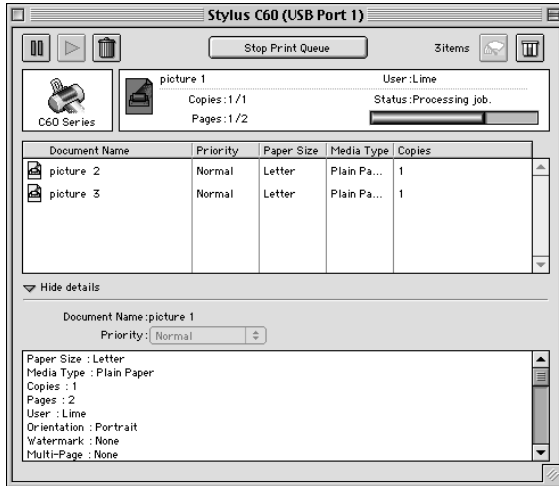

## Changing the priority of print jobs

To change the priority of print jobs in a print queue, follow the steps in this section.

### Note:

*You can also change the priority of print jobs whose print times were previously set in the printer software's Background Printing dialog box.*

1. In the Document Name column, select the print job for which you want to change the priority.



2. Click the Show details arrow to open an extension at the bottom of the EPSON Monitor3 dialog box, similar to the one below.

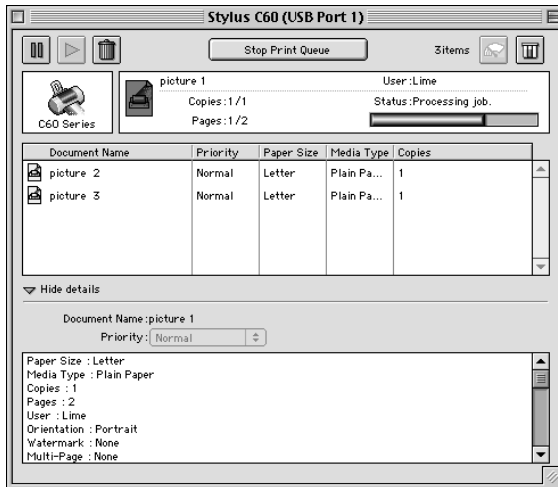

3. From the Priority list, select Urgent, Normal, Hold, or Print Time.

**Note:**

*If you select Print Time, a dialog box opens where you can specify the date and time that the document will print. Make sure that your printer and computer are turned on at the specified time.*



# Setting Up Your Printer on a Network

---

## For Windows Me, 98, and 95 Users

---

This section tells you how to set up your printer so that other computers on a network can use it.

First, you need to set up the printer as a shared printer on the computer to which the printer is connected. Then, you must add the printer to each computer that will access it through the network.

**Note:**

*This section describes how to use your printer as a shared printer on a network. To connect your printer directly to a network without setting it up as a shared printer, consult your network administrator.*

## Setting up your printer as a shared printer

To share a printer with other computers on a network, follow the steps below to configure the computer to which the printer is connected.

1. Click Start, point to Settings, then click Control Panel.
2. Double-click the Network icon.
3. Click the File and Print Sharing button.

4. Select the I want to be able to allow others to print to my printer(s) check box and click OK.



5. In the Network dialog box, click OK.
6. In the Control Panel, double-click the Printers icon.

**Note:**

- ❑ *If a dialog box requesting the insertion of the Windows Me, 98 or 95 CD-ROM appears, insert the CD in the CD-ROM drive and follow the on-screen instructions.*
  - ❑ *If a dialog box requesting that you to restart your computer appears, do so. Then, open the Printers folder, and continue from step 7.*
7. Select the icon for your printer in the Printers folder, then click Sharing on the File menu.

8. Select **Shared As**, then type the printer information as required and click **OK**.

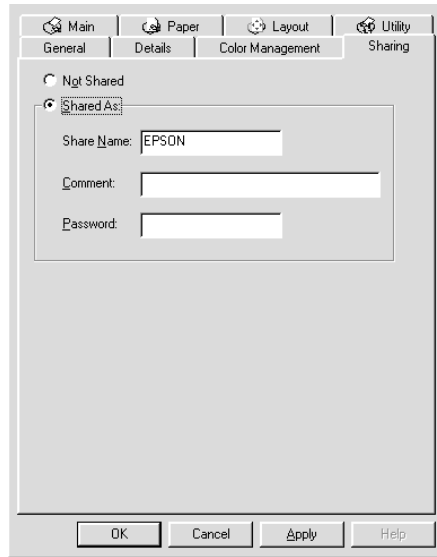

## Accessing the printer through a network

To use your printer from other computers on a network, you must first add the printer to each computer that will access it. Follow the steps below.

**Note:**

*Your printer must be set up as a shared resource on the computer to which it is directly connected before you can access it from another computer. For instructions, see "Setting up your printer as a shared printer" on page 6-1.*

1. Click **Start**, point to **Settings**, and click **Printers**.
2. Double-click the **Add Printer** icon. The **Add Printer Wizard** opens.
3. Click **Next**.

4. Select Network printer, then click Next.



5. On the next screen, click Browse.
6. Double-click the icon of the computer that is directly connected to the printer. Then, click the icon for the appropriate printer.

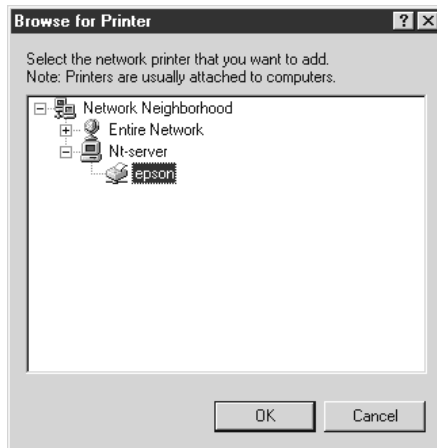

7. Click OK and follow the on-screen instructions.

**Note:**

To monitor the status of a shared printer, you must install EPSON Status Monitor 3 on each computer that will access the printer. See "Installing EPSON Status Monitor 3" on page 6-5 for instructions.

## **Installing EPSON Status Monitor 3**

To monitor the status of a printer accessed through a network, you must install EPSON Status Monitor 3 on each computer that will access the printer. Follow the steps below.

1. Insert the printer software CD in the CD-ROM drive. If the Installer dialog box does not appear, double-click EPsetup.exe in the CD-ROM.
2. Select Install EPSON Status Monitor 3, and click .
3. Follow the on-screen instructions.

---

## **For Windows 2000 Users**

This section tells you how to set up your printer so that other computers on the network can use it.

**Note:**

*This section is written for small network users only. If you are on a large network and would like to share your printer, consult your network administrator.*

First, you need to set up the printer as a shared printer on the computer to which the printer is connected. Then, you must add the printer to each computer that will access it through the network.

## Setting up your printer as a shared printer

To share a printer with other computers on a network, follow the steps below to configure the computer to which the printer is connected.

1. Click Start, point to Settings, and click Printers.
2. Right-click the icon for your printer, then click Sharing.
3. Select Shared as, then type a name for the shared printer.

**Note:**

*Do not use spaces or hyphens in the printer name.*

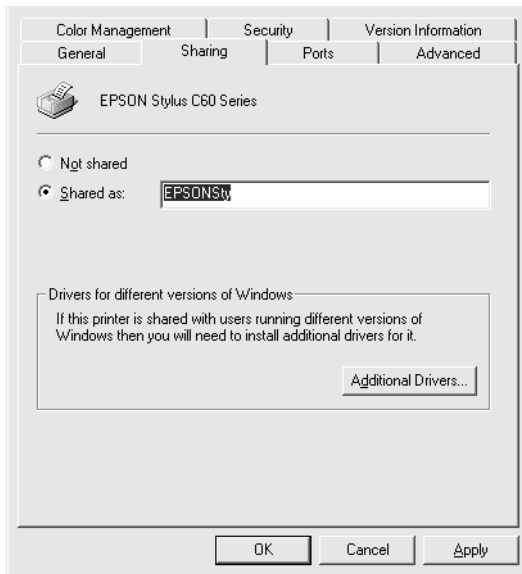

If you want Windows 2000 to automatically download printer drivers to computers that are not running Windows 2000, click Additional Drivers and select the environment and the operating system for the other computers. Click OK to install the additional drivers.



4. Click OK, or click Close if you installed additional drivers.

## Accessing the printer through a network

To use your printer from other computers on a network, you must first add the printer to each computer that will access it. Follow the steps below.

### *Note:*

*Your printer must be set up as a shared resource on the computer to which it is directly connected before you can access it from another computer. For instructions, see “Setting up your printer as a shared printer” on page 6-6.*

1. Click Start, point to Settings, and click Printers.
2. Double-click the Add Printer icon. The Add Printer Wizard opens.
3. Click Next.
4. Select Network printer, then click Next.

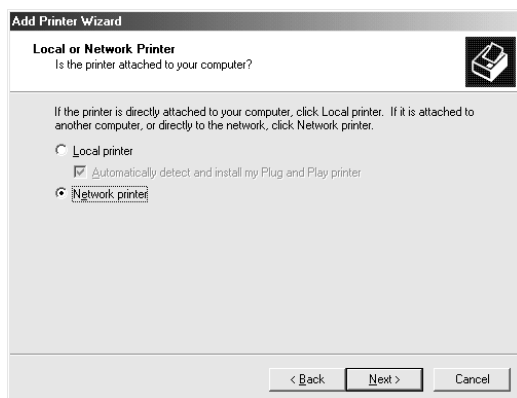

5. On the next screen, click Next.

6. Double-click the icon of the computer that is directly connected to the printer. Then, click the icon for the appropriate printer.

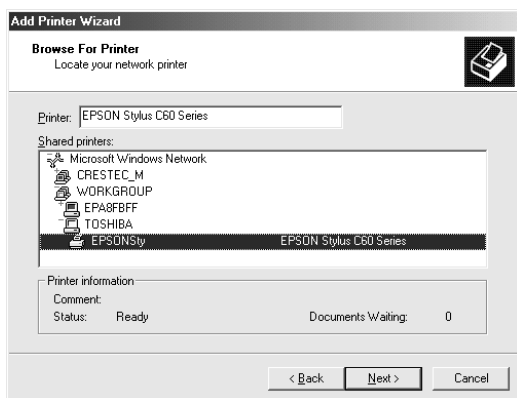

7. Click Next and follow the on-screen instructions.

**Note:**

- ❑ Depending on the operating system and the configuration of the computer to which the printer is connected, the Add Printer Wizard may prompt you to install the printer driver from the printer software CD-ROM. In this case, click the Have Disk button and follow the on-screen instructions.
- ❑ To monitor the status of a shared printer, you must install EPSON Status Monitor 3 on each computer that will access the printer. See "Installing EPSON Status Monitor 3" on page 6-8 for instructions.

### **Installing EPSON Status Monitor 3**

To monitor the status of a printer accessed through a network, you must install EPSON Status Monitor 3 on each computer that will access the printer. Follow the steps below.

1. Insert the printer software CD in the CD-ROM drive. If the Installer dialog box does not appear, double-click EPsetup.exe in the CD-ROM.
2. Select Install EPSON Status Monitor 3, and click .
3. Follow the on-screen instructions.

---

## **For Macintosh Users**

This section tells you how to set up the printer so that you can use it on an AppleTalk network. By setting up your printer as a shared printer, your local printer is connected to the network and can be used by other computers.

First, you need to set up the printer as a shared printer on the computer to which the printer is connected. Then, you must specify the network path to the printer from each computer that will use it, and install the printer software on those computers.

### **Setting up your printer as a shared printer**

To share a printer with other computers on an AppleTalk network, follow the steps below to configure the computer to which the printer is connected.

1. Turn on the printer.

2. Choose Chooser from the Apple menu and click the icon for your printer. Then, select the port to which the printer is connected.

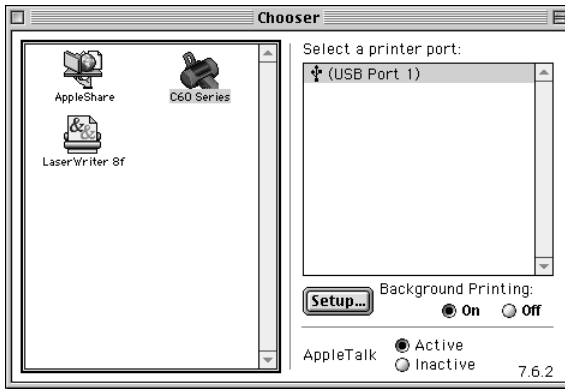

3. Click the Setup button. The Printer Sharing Setup dialog box opens.



4. Select the Share this Printer check box, then type the printer name and password information as necessary.
5. Click OK. The name of the shared printer appears in the port list in the Chooser.
6. Close the Chooser.

# Accessing the printer through a network

To access your printer from other computers on a network, follow the steps in this section for each computer that will access the printer.

1. Turn on your printer.
2. Install the printer software from the printer software CD-ROM.
3. Choose Chooser from the Apple menu. Then, click the appropriate printer icon and select the printer port that you want to use from the Select a printer port list.

**Note:**

*Only printers that are connected to your current AppleTalk zone are available.*

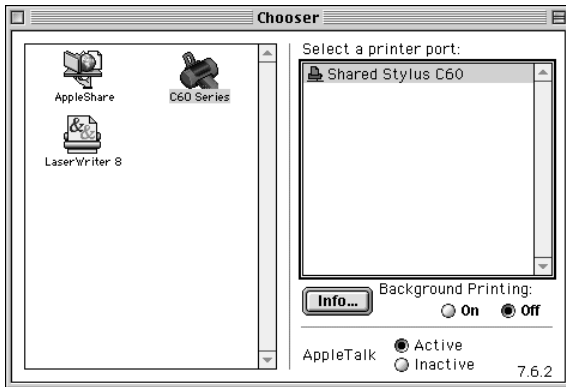

If the following dialog box appears, enter the password for the printer, then click OK.



4. Select the appropriate Background Printing radio button to turn background printing on or off.
5. Close the Chooser.

## Increasing the Print Speed

### General tips

Just as printing at a high resolution requires more processing time than printing at a low resolution, printing in color takes longer than printing in black-and-white because the volume of data in a color document is much greater. For this reason, it is important to be selective in your use of color if you also require a fast print speed.

However, even if your document requires the highest resolution and extensive use of color – for example, when you are printing a camera-ready composite that includes color photographs – it may still be possible to optimize the print speed by adjusting other printing conditions. Keep in mind that changing some conditions to increase the print speed may also lower print quality.

The following table shows the factors that inversely affect print speed and print quality (increasing one will decrease the other).

Print quality Print speed		Lower Faster	Higher Slower	Menu or dialog box
Printer software settings	Print Quality	Economy, Normal	Photo	Advanced dialog box
	High Speed	On	Off	
	Finest Detail	Off	On	
Data characteristics	Image size	Small	Large	–
	Resolution	Low	High	

The table below shows the factors related to print speed only.

Print speed		Faster	Slower	Menu or dialog box
<b>Printer software settings</b>	Ink	Black	Color	Advanced dialog box, Main menu (Windows), Print dialog box (Macintosh)
	Flip Horizontal*	Off	On	Advanced dialog box
	Collate*	Off	On	Paper menu (Windows), Layout dialog box (Macintosh)
	Reverse Order*	Off	On	
<b>Data characteristics</b>	Variety of colors	Grayscale**	Full color	–
<b>Hardware resources</b>	System speed	Faster	Slower	–
	HDD free space	Large	Small	
	Memory free space	Large	Small	
<b>Software status</b>	Running applications	One	Many	–
	Virtual memory	Not in use	In use	

\* Varies depending on the printer software and application that you are using.

\*\* Grayscale means using black ink only to print varying shades of gray, ranging from pure black to pure white.



---

## Using the Speed & Progress dialog box (Windows only)

Windows users can make certain print speed settings in the Speed & Progress dialog box. Click the Speed & Progress button on your printer software's Utility menu. The following dialog box appears.

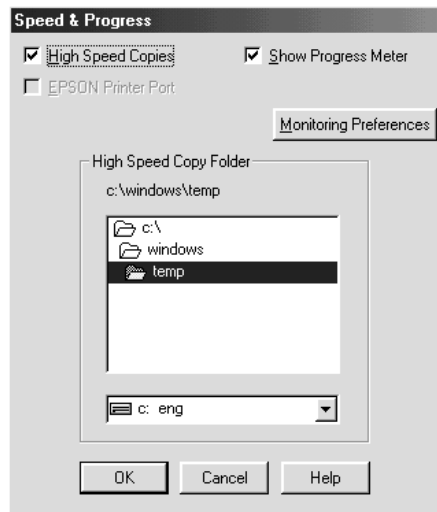

The settings related to print speed are listed below.

**Note:**

*The specific features available in the printer software vary depending on the printer model and the version of Windows that you are using.*

### High Speed Copies

To print multiple copies of your document faster, select High Speed Copies. This speeds up printing by using your hard disk space as a cache when printing multiple copies of your document.

## EPSON Printer Port

For printer models that use the parallel port, select this check box to enable the EPSON printer port, which is optimized for EPSON printers, instead of the Windows default printer port. This speeds up the data transfer rate to EPSON printers. Parallel port users can further increase print speed by enabling DMA transfer, as explained below.

### Enabling DMA transfer

If your computer has a parallel port which supports ECP mode, you can enable DMA transfer to speed up printing. See your computer manual to determine if it supports ECP mode and DMA transfer.

To determine whether you need to enable DMA transfer, compare the message below the EPSON Printer Port check box to this table, and take the recommended action.

Message	Action
High Speed (DMA) Transfer enabled.	DMA transfer is already enabled. Click OK to close the dialog box.
For higher data transfer rates, use DMA Transfer.	Follow the steps below this table to enable DMA transfer.
(No message)	Your system's parallel port setting does not allow DMA transfer. However, if you change the parallel port setting to ECP or Enhanced using your computer's BIOS Setup program, you may be able to use DMA transfer. Consult your computer manual or computer manufacturer for instructions. Once you change the parallel port setting, follow the steps below this table to enable DMA transfer.  <b>Note:</b> Before you run the BIOS Setup program, uninstall the printer software using Add/Remove Programs in the Control Panel. After running the BIOS Setup program, reinstall the printer software.

If you want to enable DMA transfer, follow the steps below.

1. Double-click the My Computer icon on your desktop and then Control Panel.
2. Double-click the System icon and click the Device Manager tab.
3. Double-click the Ports (COM & LPT) icon and then the LPT1 icon. If your printer is connected to a port other than LPT1, double-click the appropriate port icon.
4. Click the Resources tab, then clear the Use automatic settings check box. Write down the Input/Output Range settings shown in the resource settings box.

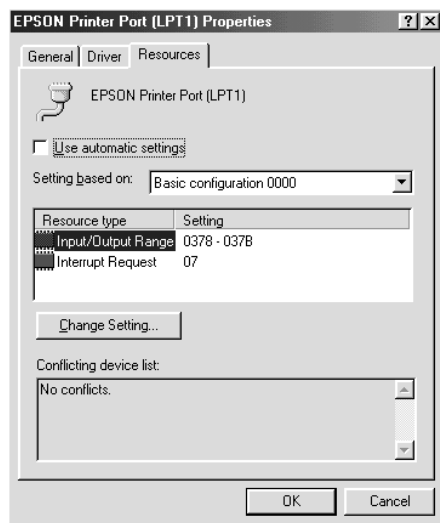

5. Select a basic configuration setting from the Setting based on list that uses the same Input/Output Range settings as those you wrote down in Step 4, and make sure that the Direct Memory Access channel and Interrupt Request numbers are allocated and displayed. Confirm also that the Conflicting device list text box shows No conflicts.

6. Click OK to save the settings.
7. Reopen the Speed & Progress dialog box to verify whether DMA transfer has been enabled.

**Note:**

*You may not be able to use DMA transfer on some computers even after you make the settings explained above. Consult your computer maker for information on the DMA transfer capability of your computer.*

---

# Replacing Ink Cartridges

---

## Introduction

This printer use ink cartridges equipped with IC chips. The IC chip accurately monitors the amount of ink used by each cartridge, so even if a cartridge is removed and later reinserted, all of its ink can be used. However, some ink is consumed each time the cartridge is inserted because the printer automatically checks reliability.



You can replace an ink cartridge using the printer's control panel or using the Status Monitor utility. Refer to the appropriate section below for instructions.

---

## Using the Printer's Control Panel









The printer's indicator lights will inform you when it is time to obtain a replacement ink cartridge and when it is time to replace an empty cartridge.

This table describes the status of the lights on your printer and the actions you need to take.

Lights	Action
	Obtain a replacement black (T028) or color (T029) ink cartridge.
	Replace the empty black or color ink cartridge.

● = on, ◐ = flashing

To find out which ink cartridge is empty, check EPSON Status Monitor 3 (for Windows) or EPSON StatusMonitor (for Macintosh). You can also tell which cartridge is empty by checking the speed at which the  error light flashes when the print head moves to the ink cartridge replacement position. See the table below.

Lights	Action
 	Replace the black ink cartridge if the  error light flashes at the same speed as the power light.
 	Replace the color ink cartridge if the  error light flashes at twice the speed of the  power light.
 	Replace both the black and color ink cartridges if this light remains on.



### **Warning:**

- Keep ink cartridges out of the reach of children. Do not allow children to drink from or otherwise handle the cartridges.*
- Be careful when you handle the used ink cartridges, as there may be some ink around the ink supply port. If ink gets on your skin, wash the area thoroughly with soap and water. If ink gets into your eyes, flush them immediately with water. If discomfort or vision problems remain after a thorough flushing, see a doctor immediately.*



**Caution:**

- ❑ *EPSON recommends the use of genuine EPSON ink cartridges. Other products not manufactured by EPSON may cause damage to your printer not covered by EPSON's warranties.*
- ❑ *Leave the old cartridge installed in the printer until you have obtained a replacement; otherwise, ink remaining in the print head nozzles may dry out.*
- ❑ *Do not refill the ink cartridges. The printer calculates the amount of ink remaining using an IC chip on the ink cartridge. Even if the cartridge is refilled, the amount of ink remaining will not be recalculated by the IC chip and the amount of ink available for use will not change.*



**Note:**

- ❑ *You cannot continue printing with one ink cartridge empty, even if the other cartridge still contains ink. Before printing, replace the empty cartridge.*
- ❑ *In addition to the ink used during document printing, ink is consumed during the print head cleaning operation, during the self-cleaning cycle which is performed when the printer is turned on, and during ink charging when the ink cartridge is installed in the printer.*

For more information about ink cartridges, see “When handling the ink cartridges” on page -3.

To replace an ink cartridge using the  ink cartridge replacement button, follow the steps below.

1. Make sure that the printer is on. The  power light should be on, but not flashing.
2. Lower the output tray, then open the printer cover.

3. Press the  ink cartridge replacement button. The print head moves to the ink cartridge replacement position, the  power light begins to flash, and the  error light begins to flash or remains on. To find out which cartridge requires replacing, see “Using the Printer's Control Panel” on page 8-1, or check EPSON Status Monitor 3 (for Windows) or EPSON StatusMonitor (for Macintosh).

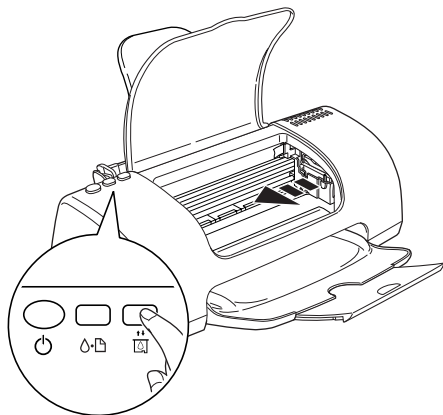

**Caution:**

*Do not move the print head by hand, as this may damage the printer. Always press the  ink cartridge replacement button to move it.*



4. Lift up the ink cartridge clamp as far as it will go. The cartridge rises partly out of the cartridge holder.

The illustration shows color ink cartridge replacement. To replace the black ink cartridge, lift up only the smaller clamp on the left.

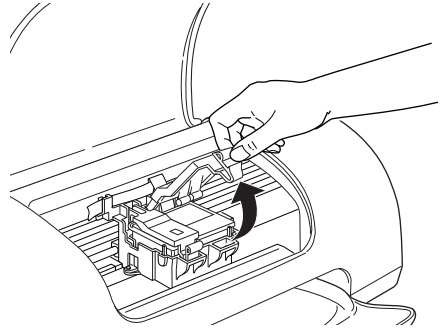

5. Lift the cartridge out of the printer and dispose of it properly. Do not take the used cartridge apart or try to refill it.

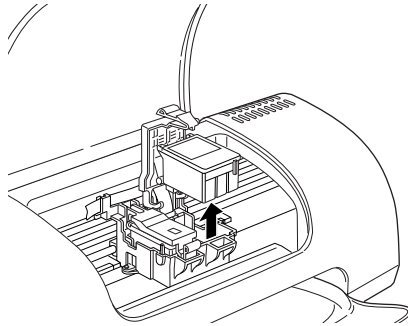

6. Remove the new ink cartridge from its protective bag. Next, remove only the yellow tape seal from the cartridge. Do not touch the green IC chip on the side of the cartridge.

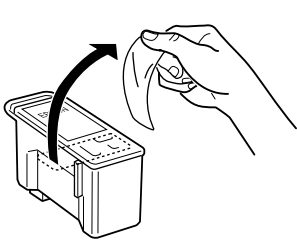

black ink cartridge (T028)

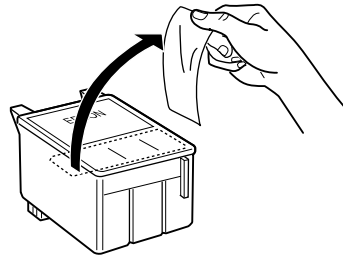

color ink cartridge (T029)



**Caution:**

- ❑ You must remove the yellow tape seal from the cartridge before installing it; otherwise, the cartridge will become unusable and you will be unable to print.
- ❑ If you have installed an ink cartridge without removing the yellow tape seal, you must remove the cartridge and install a new one. Prepare the new cartridge by removing the yellow tape seal, then install it in the printer.
- ❑ Do not remove the blue portion of the tape seal from the top of the cartridge; otherwise, the print head may become clogged and be unable to print.
- ❑ Do not remove the tape seal from the bottom of the cartridge; otherwise, ink will leak.
- ❑ Do not remove the green IC chip from the side of the cartridge. If you install an ink cartridge without an IC chip, the printer may be damaged.
- ❑ Do not touch the green IC chip on the side of the cartridge; otherwise, normal operation and printing may not be possible.

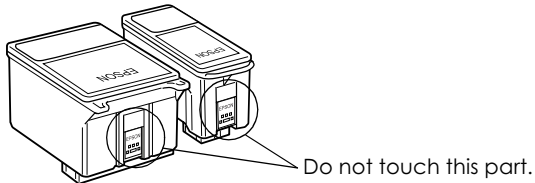

7. Align the tabs on the ink cartridge so that they are resting on the tabs protruding from the base of the opened ink cartridge clamp. Push the clamps down until they lock firmly into place.

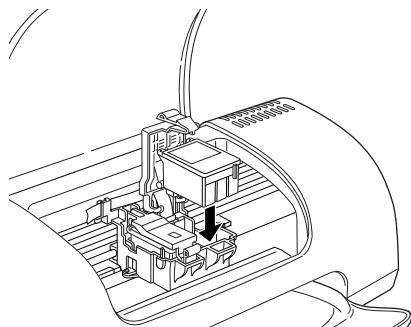

8. Lower the ink cartridge clamp until it locks into place.

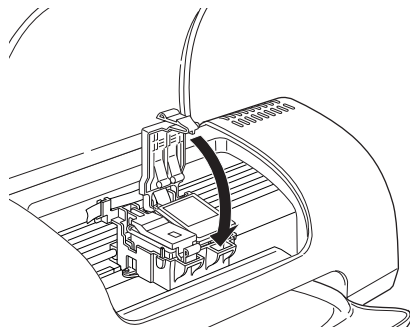

The illustration shows color ink cartridge replacement. To replace the black ink cartridge, replace only the cartridge held by the smaller clamp on the left.



**Caution:**

*After you remove an ink cartridge from the printer, insert a new one immediately. If no cartridge is present, the print head may dry out and become unable to print.*

9. Close the printer cover.

10. Press the  ink cartridge replacement button. The printer moves the print head and begins charging the ink delivery system. This process takes about thirty seconds to complete. When the ink charging process is finished, the printer returns the print head to its home position, the  power light stops flashing and remains on, and the  error light goes out.

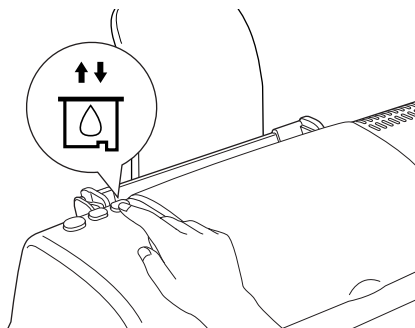

**Caution:**

The  power light continues to flash while the printer is charging ink. Never turn off the printer while this light is flashing. Doing so can result in incomplete charging of ink.

---

## Using the Status Monitor

You can monitor the remaining ink levels from your computer and view on-screen instructions for replacing a low or empty ink cartridge using EPSON Status Monitor 3 (for Windows) or EPSON StatusMonitor (for Macintosh).

When an ink cartridge is low or empty, click the How to button in the EPSON Status Monitor window. Follow the on-screen instructions to replace the cartridge.

For more information on using EPSON Status Monitor, see “Using EPSON Status Monitor 3” on page 3-3 for Windows, or “Using EPSON StatusMonitor” on page 5-1 for Macintosh.

---

# Checking the Ink Supply

## For Windows users

You can check the amount of ink remaining in the ink cartridges using EPSON Status Monitor 3 or the Progress Meter. Refer to the appropriate section below for details.

### EPSON Status Monitor 3

Access EPSON Status Monitor 3 in one of the following ways.

- ❑ Double-click the printer-shaped shortcut icon on your Windows taskbar. To add a shortcut icon to the taskbar, see “Monitoring Preferences” on page 2-33.
- ❑ Open the printer software, click the Utility tab, then click the EPSON Status Monitor 3 button.

A graphic display showing the amount of ink remaining appears.

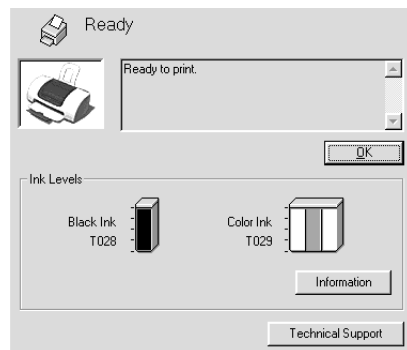

**Note:**

For the color ink cartridge, the color with the least amount of ink remaining determines the level that is displayed for all of the colors in the cartridge.

## Progress Meter

The Progress Meter dialog box appears automatically when you send a print job to the printer. You can check the amount of ink remaining from this dialog box.

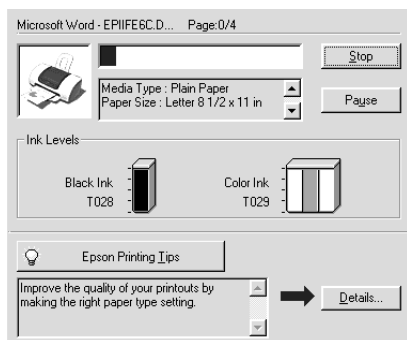

## For Macintosh users

You can check the amount of ink remaining in the ink cartridges using the StatusMonitor. Follow the steps below.

1. Click Print or Page Setup on the File menu of your application. The Print dialog box appears.
2. Click the  Utility icon button, then click the EPSON StatusMonitor button in the Utility dialog box.

A graphic displaying the amount of ink remaining appears.

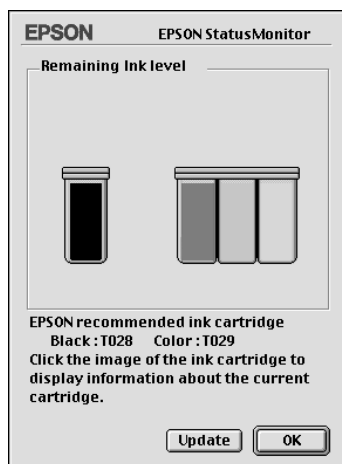

**Note:**

- ❑ *The graphic displays the amount of ink that was remaining when EPSON StatusMonitor was first opened. To update the ink-level information, click the Update button.*
  
- ❑ *For the color ink cartridge, the color with the least amount of ink remaining determines the level that is displayed for all of the colors in the cartridge.*



## Checking the Print Head Nozzles

---

If you find that the printed image is unexpectedly faint or dots in the printed image are missing, you may be able to identify the problem by checking the print head nozzles.

You can check the print head nozzles from your computer using the Nozzle Check utility in the printer software, or from the printer itself by using the printer's control panel buttons.

### Using the Nozzle Check utility

Refer to the appropriate section below to use the Nozzle Check utility.

**Note:**

*Do not use the Nozzle Check utility while printing is in progress; otherwise, your printout may be marred.*

### For Windows users

Follow the steps below to use the Nozzle Check utility.

1. Make sure that A4 or Letter size paper is loaded in the sheet feeder.
2. Right-click the printer icon on the taskbar, then select Nozzle Check. Or access the printer software, then click the Utility tab and click the Nozzle Check button.
3. Follow the on-screen instructions.





## For Macintosh users

Follow the steps below to use the Nozzle Check utility.

1. Access the Print or Page Setup dialog box and click the  Utility icon button, then click the Nozzle Check button in the Utility dialog box.
2. Follow the on-screen instructions.

## Using the control panel buttons

Follow the steps below to check the print head nozzles using the control panel buttons.

1. Turn off your printer.
2. Make sure that A4 or Letter size paper is loaded in the sheet feeder.
3. Hold down the  maintenance (① in the illustration below) button and press the  power button (② in the illustration below) to turn on the printer. Then release only the  power button. When the printer starts the operation check, release the  maintenance button.

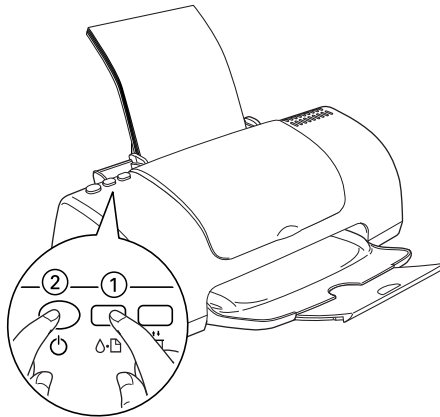

The printer prints an operation check page that includes your printer's ROM version information, the ink counter code, and a nozzle check pattern. Below are sample printouts.

Good sample



Print head needs to be cleaned

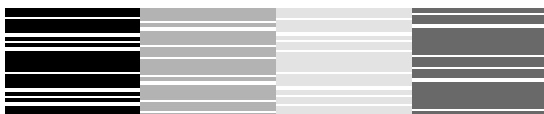

The above sample is in black and white, but the actual test prints in color (CMYK).

If the nozzle check page does not print satisfactorily, there is a problem with the printer. This could be a clogged ink nozzle or a misaligned print head. See the next section for details on cleaning the print head. For information on aligning the print head, see "Aligning the Print Head" on page 9-9.

---

## ***Cleaning the Print Head***

If you find that the printed image is unexpectedly faint or dots in the printed image are missing, you may be able to solve these problems by cleaning the print head, which ensures that the nozzles are delivering ink properly.

You can clean the print head from your computer using the Head Cleaning utility in the printer software, or from the printer itself by using the printer's control panel buttons.

**Note:**

- ❑ *Print head cleaning uses both color and black ink. To avoid wasting ink, clean the print head only if print quality declines; for example, if the printout is blurry or the color is incorrect or missing.*
- ❑ *Use the Nozzle Check utility first to confirm that the print head needs to be cleaned. This saves ink.*
- ❑ *When the  error light is flashing or on, you cannot clean the print head. Replace the appropriate ink cartridge first.*
- ❑ *Do not start the Head Cleaning or Nozzle Check utility while printing is in progress; otherwise, your printout may be marred.*

## **Using the Head Cleaning utility**

Refer to the appropriate section below to use the Head Cleaning utility.

### **For Windows users**

Follow the steps below to clean the print head using the Head Cleaning utility.

1. Make sure that the printer is on and the  error light is off.

**Note:**

*If the  error light is flashing, you cannot clean the print head. Replace the appropriate ink cartridge first.*

2. Right-click the printer icon on the taskbar, then select Head Cleaning. Or access the printer software, then click the Utility tab and click the Head Cleaning button.
3. Follow the on-screen instructions.

The  power light flashes while the printer performs the cleaning cycle.



**Caution:**

*Never turn off the printer while the  power light is flashing. Doing so may damage the printer.*

4. When the  power light stops flashing, click Print Nozzle Check Pattern in the Head Cleaning dialog box to confirm that the head is clean and to reset the cleaning cycle.

Below are nozzle check patterns:

Good sample



Print head needs to be cleaned

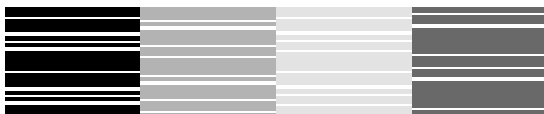

The above sample is in black and white, but the actual check pattern prints in color.

If the nozzle check page does not print satisfactorily, you may need to repeat the head cleaning and print the nozzle check pattern again.

If print quality hasn't improved after repeating this procedure four or five times, turn the printer off and leave it alone overnight. Then, do the nozzle check again, and repeat the head cleaning if necessary.

If the print quality still has not improved, one or both of your ink cartridges may be old or damaged and may need to be replaced. To replace an ink cartridge before it is empty, see "Replacing Ink Cartridges" on page 8-1.

If print quality remains a problem after replacing the ink cartridges, contact your dealer.

**Note:**

*To maintain print quality, we recommend printing a few pages at least once every month.*

## **For Macintosh users**

Follow the steps below to clean the print head using the Head Cleaning utility.

1. Make sure that the printer is on and the ⏻ error light is off.
2. Access the printer software and click the  Utility icon button, then click the Head Cleaning button.
3. Follow the on-screen instructions.

The ⏻ power light flashes while the printer performs the cleaning cycle.



**Caution:**

*Never turn off the printer while the ⏻ power light is flashing. Doing so may damage the printer.*

4. When the ⏻ power light stops flashing, click the Confirmation button in the Head Cleaning dialog box to print a nozzle check pattern and to reset the cleaning cycle. Use the check pattern to confirm that the head is clean. Refer to page 148 to see a sample of the nozzle check pattern.

If print quality has not improved after repeating this procedure four or five times, turn the printer off and leave it alone overnight. Then, do the nozzle check again, and repeat the head cleaning if necessary.

If the print quality still has not improved, one or both of your ink cartridges may be old or damaged and may need to be replaced. To replace an ink cartridge, see “Replacing Ink Cartridges” on page 8-1.



If print quality remains a problem after replacing the ink cartridges, contact your dealer.

**Note:**



*To maintain print quality, we recommend printing a few pages at least once every month.*

## **Using the control panel buttons**

Follow the steps below to clean the print head using the control panel buttons.



1. Make sure that the  power light is on and that the  error light is off.

**Note:**

*If the  error light is flashing or on, you cannot clean the print head and this operation will start the ink cartridge replacement procedure. If you do not want to replace an ink cartridge at this moment, press the  maintenance button to return the print head to its home position.*

2. Hold down the  maintenance button for three seconds.

**Note:**

If you release the  maintenance button for less than three seconds, paper will feed. Press the  maintenance button again to eject paper, then repeat step 1.

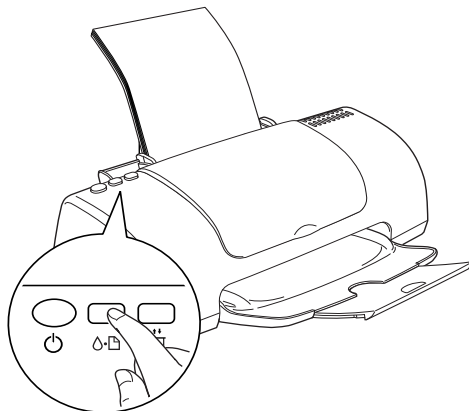

The printer starts cleaning the print head and the  power light begins flashing.



**Caution:**

*Never turn off the printer while the  power light is flashing. Doing so may damage the printer.*

3. When the  power light stops flashing, print a nozzle check pattern to confirm that the head is clean and to reset the cleaning cycle.

If print quality has not improved after repeating this procedure four or five times, turn the printer off and leave it alone overnight. Then, do the nozzle check again, and repeat the head cleaning if necessary.

If the print quality still has not improved, one or both of your ink cartridges may be old or damaged and may need to be replaced. To replace an ink cartridge before it is empty, see “Replacing Ink Cartridges” on page 8-1.



If print quality remains a problem after replacing the ink cartridges, contact your dealer.

**Note:**

*To maintain print quality, we recommend printing a few pages at least once every month.*

---

## **Aligning the Print Head**

If you notice a misalignment of vertical lines, you may be able to solve this problem from your computer using the Print Head Alignment utility in your printer software. Refer to the appropriate section below.

**Note:**

*Do not start the Print Head Alignment utility while printing is in progress; otherwise, your printout may be marred.*

### **For Windows users**

Follow the steps below to align the print head using the Print Head Alignment utility.

1. Make sure that A4 or Letter size plain paper is loaded in the sheet feeder.
2. Right-click the printer icon on the taskbar, then select Print Head Alignment. Or access the printer software, then click the Utility tab and click the Print Head Alignment button.
3. Follow the on-screen instructions to align the print head.

## For Macintosh users

Follow the steps below to align the print head using the Print Head Alignment utility.

1. Make sure that A4 or Letter size plain paper is loaded in the sheet feeder.
2. Access the printer software and click the  Utility icon button, then click the Print Head Alignment button.
3. Follow the on-screen instructions to align the print head.

---

## Cleaning the Printer

To keep your printer operating at its best, clean it thoroughly several times a year as follows.

1. Unplug the printer's power cord.
2. Remove any paper from the sheet feeder.
3. Use a soft brush to carefully clean away all dust and dirt from the sheet feeder.
4. If the outer case or the inside of the sheet feeder is dirty, clean it with a soft, clean cloth dampened with mild detergent. Keep the printer cover closed to prevent water getting inside.
5. If the inside of the printer accidentally gets soiled with ink, wipe it off with a damp cloth.



**Warning:**

*Be careful not to touch the gears inside of the printer.*



**Caution:**

- ❑ *Be careful not to wipe the carriage shaft.*
- ❑ *Never use alcohols or thinners to clean the printer; these chemicals can damage the components as well as the case.*
- ❑ *Be careful not to get water on the printer mechanism or electronic components.*
- ❑ *Do not use a hard or abrasive brush.*
- ❑ *Do not spray the inside of the printer with lubricants. Unsuitable oils can damage the mechanism. Contact your dealer or a qualified service person if lubrication is needed.*

---

## Transporting the Printer

If you need to transport your printer, carefully prepare and repack it as described below using the original box (or a similar box that the printer fits snugly into) and packing materials. Follow the steps below.

1. Open the printer cover and make sure that the print head is in the home (far right) position. If not, plug in the printer and wait until the print head returns to the home position. Then, close the printer cover and unplug the printer.



**Caution:**

*Leave the ink cartridges installed when you transport the printer. Removing the cartridges during transport can damage the printer.*

2. Disconnect the interface cable from the printer.
3. Remove the paper from the sheet feeder and remove the paper support.

4. Open the printer cover again. Secure the ink cartridge holder to the printer with the protective material and tape as shown below, then close the printer cover.

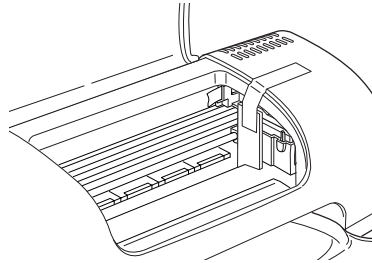

5. Raise the output tray.
6. Attach the protective materials to both sides of the printer.
7. Repack the printer and power cord in the original box.
8. Keep the printer level during transport.

---

## **Updating and Uninstalling Software**

See this section when upgrading your Windows operating system, updating the printer software in Windows Me or Windows 2000, or when uninstalling the printer driver from Windows or Macintosh.

### **Updating to Windows Me or 98**

If you have upgraded your computer's operating system from Windows 95 to Windows Me or 98, you must uninstall your printer software and then install it again. See "Uninstalling the printer driver" on page 9-13 for instructions.

## **Updating the printer software in Windows Me or 2000**

When you update the printer software in Windows Me or 2000, please be sure to uninstall the previous printer software before you install the new software. Installing over the existing printer software results in a failure to update. See “Uninstalling the printer driver” on page 9-13 for details on uninstalling the printer software.

### **Uninstalling the printer driver**

#### **For Windows**

1. Turn off the printer and disconnect the cable from the printer.
2. Click the Start button and select Settings, then choose Control Panel.
3. Double-click the Add/Remove Programs icon and select EPSON Printer Software from the list. Then, click the Add/Remove button.
4. Select the EPSON Stylus C60 Series icon and click OK.
5. Select OK.

#### **Note:**

*If you are using the USB port to connect the printer in Windows Me or 98, you need to uninstall an additional USB component. Select EPSON USB Printer Device from the list in the Add/Remove Programs utility, then click the Add/Remove button and click OK when a message prompts you to restart the computer. If EPSON USB Printer Device does not appear in the Add/Remove Programs list, double-click EPUSBUN.EXE and EPUBLUN.EXE on the printer software CD-ROM, then follow the on-screen instructions.*

## For Macintosh

1. Turn on your Macintosh and insert the software CD in the CD-ROM drive. The EPSON printer software disk will open automatically.
2. If a single Installer icon appears, double-click the icon. If separate folders containing installer icons for several languages appear, double-click the folder for your preferred language, then double-click the Installer icon inside it.
3. After the initial screen, click Continue. The following dialog box will appear.

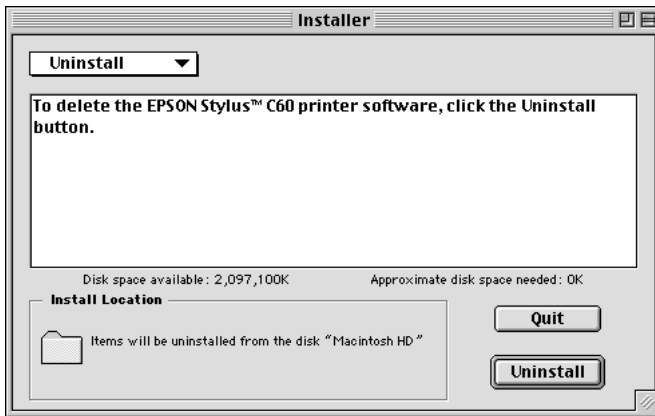

4. Select Uninstall from the pull-down menu at the top left, then click Uninstall.

# Troubleshooting

---

## Diagnosing the Problem

If you are connecting via the USB interface and are having difficulty printing, the problem may be related to your USB connection. Refer to “Correcting USB Problems” on page 10-21 for details.

If your problem is not USB related, troubleshooting printer problems is best handled in two easy steps: first diagnose the problem, then apply likely solutions until the problem is fixed.

The information that you need to diagnose and solve most common problems is provided by online problem solving, the printer’s control panel, the EPSON Status Monitor utility, or by running a printer operation check. Refer to the appropriate section below.

If you have a specific problem relating to print quality, a printout problem not related to print quality, or a paper feeding problem, or if the printer does not print at all, refer to the appropriate section in this chapter.

To solve a problem, you may need to cancel printing. For details, see “Cancelling Printing” on page 10-26.

## Online problem solving

You can use online problem solving to diagnose and solve most of the problems you may encounter. Refer to the appropriate section below.

## **For Windows users**

The Problem Solver HTML manual provides you with tips to help solve any problems you may encounter when using your printer.

If you encounter a problem, access the Problem Solver in one of the following ways:

- ❑ From the Windows Start menu

Click Start, point to Programs and then to EPSON, then click ES C60 Problem Solver.

- ❑ From Status Monitor 3

Click Technical Support in the Status Monitor 3 dialog box.

- ❑ From your printer software

Click Technical Support on the Main menu of the printer software.

If you cannot solve your problem using the Problem Solver, contact Technical Support for assistance by clicking the Technical Support Web Site link in the Problem Solver.

## **For Macintosh users**







EPSON's Technical Support Web Site provides help with problems that cannot be solved using the troubleshooting information in your printer documentation.



To access Technical Support, insert the CD in the CD-ROM drive and double-click the Technical Support Web Site icon in the EPSON window.



## Error indicators

You can identify many common printer problems using the lights on your printer's control panel. If your printer stops working and the lights are on or flashing, use the following table of panel light patterns to diagnose the problem, then follow the recommended corrective measures.

Lights	Problem and Solution	
	<b>Paper out</b>	
	No paper is loaded in the printer.	Load paper in the sheet feeder, then press the  maintenance button. The printer resumes printing and the light goes out.
	<b>Paper jam</b>	
	Paper has jammed in the printer.	Press the  maintenance button to eject the jammed paper. If the error does not clear, open the printer cover and remove all of the paper inside, including any torn pieces. Then, reload the paper in the sheet feeder and press the  maintenance button to resume printing.
	<b>Ink low</b>	
	The black or color ink cartridge is nearly empty.	Obtain a replacement black (T028) or color (T029) ink cartridge. To determine which cartridge is nearly empty, check the ink level using EPSON Status Monitor 3 (Windows) or EPSON StatusMonitor (Macintosh).

	<b>Ink out</b>	
	The black or color ink cartridge is empty or not installed.	Replace the black (T028) or color (T029) ink cartridge with a new one. See "Replacing Ink Cartridges" on page 8-1 for details.
	<b>Wrong cartridge</b>	
	The installed black or color ink cartridge cannot be used by this printer.	Use the appropriate black (T028) or color (T029) ink cartridge. See "Replacing Ink Cartridges" on page 8-1 for details.
	<b>Carriage error</b>	
	The print head carriage is obstructed by jammed paper or other foreign material and cannot return to the home position.	Turn off the printer. Open the printer cover and remove any paper or other obstructions from the paper path by hand. Then, turn the printer back on. If the error does not clear, contact your dealer.
	<b>Unknown printer error</b>	
	An unknown printer error has occurred.	Turn off the printer and contact your dealer.

● = on, ○ = off, ◐ = flashing

## EPSON Status Monitor

The EPSON Status Monitor utility provides status messages and a graphic display showing the current status of the printer.

If a problem occurs while printing, an error message appears in the Progress Meter window.

When the ink is out, click the How To button in the EPSON Status Monitor or Progress Meter window and EPSON Status Monitor will lead you step-by-step through the cartridge replacement procedure.

## Running a printer operation check

If you are unable to determine the source of the problem, performing a printer operation check can help you determine whether the problem comes from the printer or the computer.



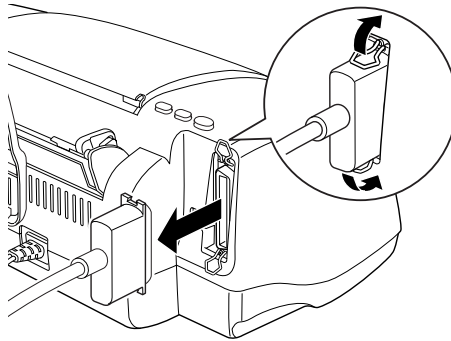

To print a printer operation check page, follow these steps.

1. Make sure both the printer and computer are turned off.
2. Disconnect the cable from the printer's interface connector.

If you use the parallel interface, unlock the wire clips on both sides of the interface connector and remove the ground connector, if necessary. Then, disconnect the cable from the printer's interface connector.



3. Make sure that A4 or Letter size paper is loaded in the sheet feeder.

4. Hold down the  maintenance button and press the  power button to turn on the printer. Then, release only the  power button. When the printer starts the operation check, release the  maintenance button.

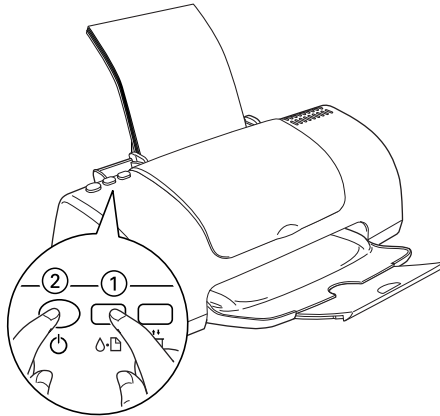

The printer prints an operation check page which includes the version of your printer's ROM, the ink counter code, and a nozzle check pattern.

Compare the quality of the printed test page with the sample shown below. If there are no print quality problems, the printer itself is fine and the problem probably lies with the printer software settings, the application settings, the interface cable (be sure to use a shielded cable), or the computer itself.



The above sample is in black and white, but the actual check page prints in color (CMYK).

If the test page does not print satisfactorily, there is a problem with the printer. For example, if bands appear in the check pattern as shown below, this could mean a clogged ink nozzle or a misaligned print head.

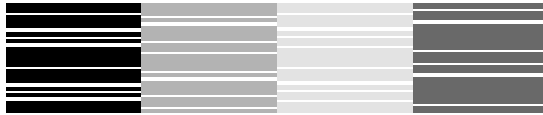

The above sample is in black and white, but the actual check pattern prints in color.

---

## **Print Quality Problems**

If you are having print quality problems, try the solutions offered in this section.

### **Horizontal banding**

Try one or more of these solutions:

- Make sure that the printable side of the paper is face up in the sheet feeder.
- Run the Head Cleaning utility to clear any clogged ink nozzles.
- Clear all customised settings, and select **Automatic** as the Mode setting on your printer software's Main menu (Windows) or in the Print dialog box (Macintosh).
- Check the  error light. If the light is flashing, replace the appropriate ink cartridge. See "Replacing Ink Cartridges" on page 8-1 for details.

- ❑ Make sure that *Maximum* is not selected as the Printable Area setting in your printer software. When this setting is selected, banding may occur in the expanded area.
- ❑ Make sure that the Media Type selected in the printer software is appropriate for the type of media loaded in the printer.
- ❑ Make sure that the *MicroWeave* check box is selected when available in the Advanced dialog box. For Windows users, see “Making Advanced settings” on page 2-12 for details. For Macintosh users, see “Making Advanced settings” on page 4-11.

## ***Vertical misalignment or banding***

Try one or more of these solutions:

- ❑ Make sure that the printable side of the paper is face up in the sheet feeder.
- ❑ Run the Print Head Alignment utility.
- ❑ Clear the High Speed check box in the Advanced dialog box. For Windows users, see “Making Advanced settings” on page 2-12 for details. For Macintosh users, see “Making Advanced settings” on page 4-11.
- ❑ Run the Head Cleaning utility to clear any clogged ink nozzles.
- ❑ Make sure that the Media Type setting selected in the printer software is appropriate for the type of media loaded in the printer.

- ❑ Make sure that the MicroWeave check box is selected when available in the Advanced dialog box. For Windows users, see “Making Advanced settings” on page 2-12 for details. For Macintosh users, see “Making Advanced settings” on page 4-11.

## **Color gaps**

Try one or more of these solutions:

- ❑ Make sure that your paper is not damaged, dirty, or too old. Also, make sure that the printable side of the paper is face up in the sheet feeder.
- ❑ Run the Head Cleaning utility to clear any clogged ink nozzles.
- ❑ Check the  error light. If the light is flashing, replace the appropriate ink cartridge. See “Replacing Ink Cartridges” on page 8-1.
- ❑ Adjust the color settings in your application or in your printer software’s Advanced dialog box. For instructions, see “Making Advanced settings” on page 2-12 for Windows or “Making Advanced settings” on page 4-11 for Macintosh.
- ❑ Clear all customised settings, and select Automatic as the Mode setting on your printer software’s Main menu (Windows) or in the Print dialog box (Macintosh).
- ❑ Make sure that the Media Type setting selected in the printer software is appropriate for the type of media that is loaded in the printer.

## **Incorrect or missing colors**

Try one or more of these solutions:

- ❑ Change the Ink setting in your printer software to Color. For instructions, see “Using the Automatic mode” on page 2-8 for Windows or “Using the Automatic mode” on page 4-8 for Macintosh.
- ❑ Adjust the color settings in your application or in your printer software’s Advanced dialog box. For instructions, see “Making Advanced settings” on page 2-12 for Windows or “Making Advanced settings” on page 4-11 for Macintosh.
- ❑ Run the Head Cleaning utility. If colors are still incorrect or missing, replace the color ink cartridge. If the problem persists, replace the black ink cartridge. See “Replacing Ink Cartridges” on page 8-1 for details.
- ❑ Do not use ink cartridges beyond the expiration data printed on the cartridge package. Also, if the printer has not been used for a long time, replace the ink cartridges. See “Replacing Ink Cartridges” on page 8-1.

## ***Blurry or smeared printout***

Try one or more of these solutions:

- ❑ Make sure that you are using the appropriate printer driver for your printer.
- ❑ Use only paper recommended by EPSON.
- ❑ Make sure that the printer is on a flat, stable surface that extends beyond the printer base in all directions. The printer will not operate properly if it is tilted.
- ❑ Make sure that your paper is not damaged, dirty, or too old. Also, make sure that the printable side of the paper is face up in the sheet feeder.



- ❑ Make sure that your paper is dry and that the printable side is facing up. Also, make sure that you are using an acceptable paper type. See “Paper” on page A-1 for specifications.
- ❑ Clear all customised settings, and select Automatic as the Mode setting on your printer software’s Main menu (Windows) or in the Print dialog box (Macintosh).
- ❑ If the paper is curled toward the printable side, flatten it or curl it slightly toward the opposite side.
- ❑ Remove each sheet from the output tray as it is printed, especially if you are using transparencies.
- ❑ If you are printing on glossy media or transparencies, place a support sheet (or a sheet of plain paper) beneath the stack. Or, load only one sheet at a time.
- ❑ Run the Head Cleaning utility.
- ❑ Run the Print Head Alignment utility.
- ❑ Load and eject dry paper several times. If the problem persists, ink may have leaked inside the printer, so wipe the inside of the printer with a soft, clean cloth.

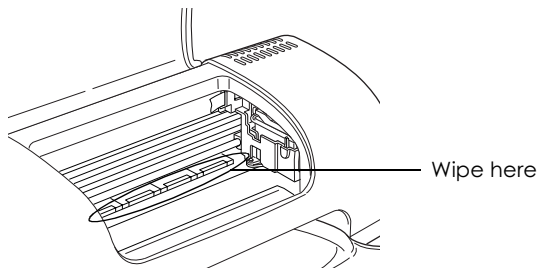

**Warning:**

*Be careful not to touch the gears inside the printer.*



**Caution:**

*Be careful not to wipe the carriage shaft.*

---

## ***Printout Problems Not Related to Print Quality***

If one of the following problems has occurred, try the solutions listed for the problem.

- Incorrect or garbled characters
- Incorrect margins
- Inverted image
- Blank pages print
- Printout has smears on the bottom edge
- Printing is too slow

### ***Incorrect or garbled characters***

Try one or more of these solutions:

- Make sure that you are using the appropriate printer driver for your printer.
- Select your printer as the default printer in Windows.
- Windows Me, 98 and 95 users can clear any stalled print jobs from the Spool Manager. For instructions, see "Using EPSON Spool Manager" on page 10-27.
- Turn off the printer and computer. Make sure that the printer's interface cable is securely plugged in.

### ***Incorrect margins***

Try one or more of these solutions:

- ❑ Check the margin settings in your application. Make sure that the margins are within the printable area of the page. See “Paper” on page A-1 for specifications.
- ❑ Check the settings on the Paper menu (Windows) or in the Page Setup dialog box (Macintosh). Make sure the settings are appropriate for the paper size you are using.

## ***Inverted image***

Clear the Flip Horizontal check box in the printer software, or turn off the “Mirror” setting in your application. For instructions, see online help for the printer software or for your application.

Macintosh users can refer to “Making Advanced settings” on page 4-11 for details.

## ***Blank pages print***

Try one or more of these solutions:

- ❑ Make sure that you are using the appropriate printer driver for your printer.
- ❑ Windows users can make sure that their printer is selected as the default printer.
- ❑ Check the settings on the Paper menu (Windows) or in the Page Setup dialog box (Macintosh). Make sure the settings are appropriate for the paper size you are using.
- ❑ Run the Head Cleaning utility to clear any clogged nozzles.

After trying one or more of these solutions, run a printer operation check to check your results. See “Running a printer operation check” on page 10-5 for details.

## ***Printout has smears on the bottom edge***

If the paper is curled toward the printable side, flatten it or curl it slightly toward the opposite side.

## ***Printing is too slow***

Try one or more of these solutions:

- ❑ Make sure that the Media Type setting in your printer software is correct. For instructions, see “Making the Media Type setting” on page 2-3 for Windows or “Making the Media Type setting” on page 4-2 for Macintosh.
- ❑ Select Automatic as the Mode setting on your printer software’s Main menu (Windows) or in the Print dialog box (Macintosh) and then move the slider to Speed. For instructions, see “Using the Automatic mode” on page 2-8 for Windows or “Using the Automatic mode” on page 4-8 for Macintosh.
- ❑ Close any applications that you are not using at the moment.
- ❑ If you upgraded from Windows 95 to Windows 98, uninstall the printer software using Add/Remove Programs in the Control Panel in Windows, then install the software again.
- ❑ For printer models that use the parallel port, you can enable DMA transfer if your computer supports ECP mode. See “Enabling DMA transfer” on page 7-16.

---

## ***Paper Does Not Feed Correctly***

If one of the following problems has occurred, try the solutions listed for that problem.

- Paper does not feed
- Multiple pages feed
- The paper jams
- Paper is not ejected fully or is wrinkled
- Paper does not feed correctly when using the double-sided printing feature

## ***Paper does not feed***

Remove the stack of paper and make sure of the following:

- The paper is not curled or creased.
- The paper is not too old. See the instructions that came with the paper for more information.
- The paper stack fits under the tabs inside the edge guides.
- The number of sheets in the paper stack does not exceed the limit specified for the media. See “Loading capacities for EPSON special media” on page 1-5 for details.
- The paper is not loaded above the arrow on the edge guide.
- Paper is not jammed inside the printer. If it is, remove the jammed paper.
- The ink cartridges are not empty. Replace cartridges as necessary. See “Replacing Ink Cartridges” on page 8-1.

After trying the solutions above, load the paper again. Make sure that you follow any special loading instructions that came with your paper. See also “Paper Handling” on page 1-1.

## Multiple pages feed

- ❑ Make sure that the paper stack fits under the arrow mark located on the inside surface on the left edge guide.
- ❑ Make sure that the paper is loaded under the tabs inside the edge guides.
- ❑ Make sure that the left edge guide is flush against to the left edge of the paper.
- ❑ Make sure that the paper is not curled or folded. If it is, flatten it or curl it slightly toward the opposite side.
- ❑ Remove the stack of paper and make sure that the paper is not too thin. See “Paper” on page A-1. Fan the edges of the stack to separate the sheets, then reload the paper.
- ❑ If too many copies of a document are being printed, check the Copies setting on the printer software’s Paper menu (Windows) or in the Print dialog box (Macintosh) and in your application. For instructions, see “Making Settings on the Paper Menu” on page 2-19 for Windows or “Making Settings in the Print Dialog Box” on page 4-2 for Macintosh.

## Paper jams

Press the ⏏ maintenance button to eject the jammed paper. If the error does not clear, open the printer cover and remove all of the paper inside, including any torn pieces. Then, reload the paper in the sheet feeder and press ⏏ maintenance button to resume printing.

### **Note:**

*If you cannot remove a foreign object easily by yourself, do not use force and do not disassemble the printer. Call your dealer for assistance.*

If your paper jams frequently, make sure of the following:

- ❑ The paper is smooth, not curled or wrinkled.
- ❑ The paper is of high quality, loaded with the printable side up.
- ❑ The paper stack was fanned before loading.
- ❑ The paper stack is loaded under the tabs inside the edge guides.
- ❑ The paper is not loaded above the arrow on the left edge guide.
- ❑ The number of sheets in the paper stack does not exceed the limited specified for the media. See “Loading capacities for EPSON special media” on page 1-5 for details.
- ❑ The left edge guide is adjusted to fit your paper.
- ❑ The printer is on a flat, stable surface that extends beyond the printer base in all directions. The printer will not operate properly if it is tilted.

## ***Paper is not ejected fully or is wrinkled***

Try one or more of these solutions:

- ❑ If the paper does not eject fully, press the ⏻ maintenance button, then open the printer cover and remove the paper. Also, check the Paper Size setting in your application or printer software.
- ❑ If the paper is wrinkled when it comes out, it may be damp or too thin. Load a new stack.

### ***Note:***

*Store any unused paper in its original package in a dry area. See “Paper” on page A-1 for specifications.*

---

## **Printer Does Not Print**

If the printer does not print, see if the status of your printer's lights is listed below, then try the solutions listed.

- All lights are off
- Lights came on and then went out
- Only the power light is on
- The ⚠ error light is flashing or on
- One of the ink out lights is flashing or on
- Ink out lights are on and the other lights are flashing

### **All lights are off**

Try one or more of these solutions:

- Press the ⏻ power button to make sure that the printer is on.
- Turn off the printer and make sure that the power cord is securely plugged in.
- Make sure that your outlet works and is not controlled by a wall switch or timer.

### **Lights came on and then went out**

The printer's voltage may not match the outlet rating. Turn off the printer and unplug it immediately. Then, check the printer labels.

If the voltage does not match, DO NOT PLUG YOUR PRINTER BACK IN. Contact your dealer.



## **Only the power light is on**

Try one or more of these solutions:

- ❑ Turn off the printer and computer. Make sure that the printer's interface cable is securely plugged in.
- ❑ Make sure that there is no packing material in the printer.
- ❑ Turn off the printer and the computer and disconnect the printer's interface cable. Then, print an operation check page. See "Running a printer operation check" on page 10-5.

If the check page prints correctly, make sure that the printer software and your application are installed correctly.

- ❑ If you are trying to print a large image, your computer may not have enough memory to print. Try printing a smaller image.
- ❑ Windows Me, 98, and 95 users can clear any stalled print jobs from the Spool Manager. For instructions, see "Using EPSON Spool Manager" on page 10-27.
- ❑ If the printer sounds like it is trying to print, but is unable to, run the Head Cleaning utility.

If this does not work, replace the ink cartridges. See "Replacing Ink Cartridges" on page 8-1 for instructions.

## **Error light is flashing or on**

Check EPSON Status Monitor 3 (for Windows) or EPSON StatusMonitor (for Macintosh) to find the cause of the error, then try one or more of these solutions:

- ❑ If the ⚠ error light is on and paper is jammed in the printer, remove the paper from the printer.

- ❑ If the ⚠ error light is on and no paper is loaded, load more paper in the sheet feeder.
- ❑ If the ⚠ error light is flashing, ink is low. Obtain a replacement cartridge of the appropriate type. To determine which cartridge is low, see “Replacing Ink Cartridges” on page 8-1.
- ❑ If the ⚠ error light is on and ink is out, replace the appropriate ink cartridge. To determine which ink cartridge is empty, see “Replacing Ink Cartridges” on page 8-1.

## **Error light is on and power light is flashing**

Follow the steps below.

1. Press the ⚠ maintenance button, then remove any paper in the printer.
2. Turn the printer off. Check for and remove any foreign objects or pieces of paper from inside the printer. Also, make sure that there is sufficient space around the vent on the back of the printer to allow proper ventilation. Remove any objects blocking the vent. Then, turn the printer back on.

**Note:**

*If you cannot remove a foreign object easily by yourself, do not use force and do not disassemble the printer. Call your dealer for assistance.*

3. If the error does not clear, contact your dealer.

---

## **Correcting USB Problems**

If you are having difficulty using your printer with a USB connection, see if your problem is listed below, and take any recommended actions.

### **USB connections**

USB cables or connections can sometimes be the source of USB problems. Try one or both of these solutions:

- ❑ Use the USB cable (C83623\*) recommended in “System Requirements” on page A-11.
- ❑ For best results, you should connect the printer directly to the computer’s USB port. If you must use multiple USB hubs, we recommend that you connect the printer to the first-tier hub.

### **Windows operating system**

Your computer must be a Windows Me, 98 or 2000 pre-installed model, or a Windows 98 pre-installed model that was upgraded to Windows Me. You may not be able to install or run the USB printer driver on a computer that does not meet these specifications, or that is not equipped with a built-in USB port.

For details about your computer, contact your dealer.

### **Printer software installation**

Incorrect or incomplete software installation can lead to USB problems. Take note of the following, and perform the recommended checks to ensure proper installation.

## Checking printer software installation for Windows 2000

When using Windows 2000, you must follow the steps in the *Setup* sheet packed with your printer to install the printer software. Otherwise, Microsoft's Universal driver may be installed instead. To check if the Universal driver has been installed follow the steps below.

1. Open the Printers folder and right-click the icon for your computer.
2. Click Printing Preference on the shortcut menu that appears, then right-click anywhere in the driver.

If ABOUT is displayed in the shortcut menu that appears, click it. If a message box with the words "Unidrv Printer Driver" appears, you must reinstall the printer software as described in the *Setup* sheet. If ABOUT is not displayed, the printer software has been installed correctly.

**Note:**

*If the Digital Signature Not Found dialog box appears during the installation process, click Yes. If you click NO, you will have to install the printer software again.*

## Checking printer software for Windows Me and 98

If you canceled the plug-and-play driver installation in Windows Me or 98 before the procedure was complete, the USB printer device driver or the printer software may be incorrectly installed. Follow the directions below to ensure that the driver and printer software are installed correctly.

**Note:**

*The screens shown in this section are for Windows 98. Windows Me screens may differ slightly.*

1. Click the Start button, point to Settings, and click Printers. Make sure that the icon for your printer appears in the Printers window.

Select the icon for your printer, then click Properties on the File menu.



2. Click the Details tab.

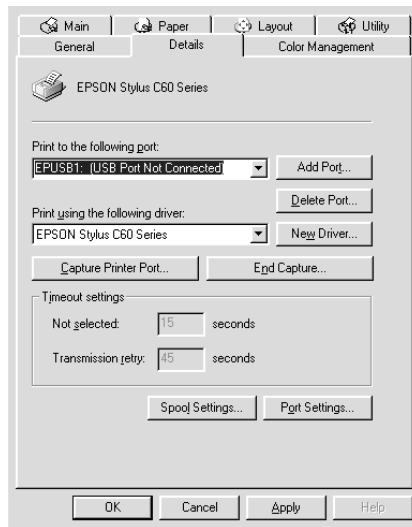

If EPUSBX: (EPSON Stylus C60 Series) is displayed in the Print to the following port list box, then the USB printer device driver and printer software is installed correctly. If the correct port is not displayed, proceed to the next step.

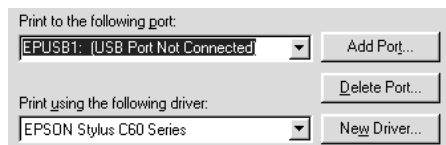

3. Right-click the My Computer icon on your desktop, then click Properties.
4. Click the Device Manager tab.

If your drivers are correctly installed, EPSON USB Printer Devices should appear on the Device Manager menu.

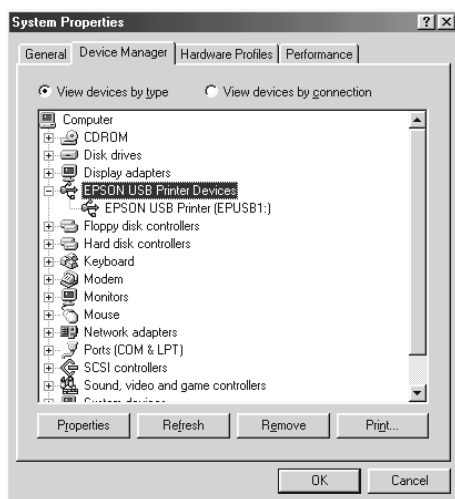

If EPSON USB Printer Devices does not appear on the Device Manager menu, click the plus (+) sign beside Other devices to view the installed devices.



If USB Printer or EPSON Stylus C60 Series appears under Other devices, the printer software is not installed correctly. Proceed to step 5.

If neither USB Printer nor EPSON Stylus C60 Series appears under Other devices, click Refresh or unplug the USB cable from the printer, then plug it into the printer again. Once you've confirmed that these items appear, proceed to step 5.

5. Under Other devices, select USB Printer or EPSON Stylus C60 Series and click Remove. Then, click OK.

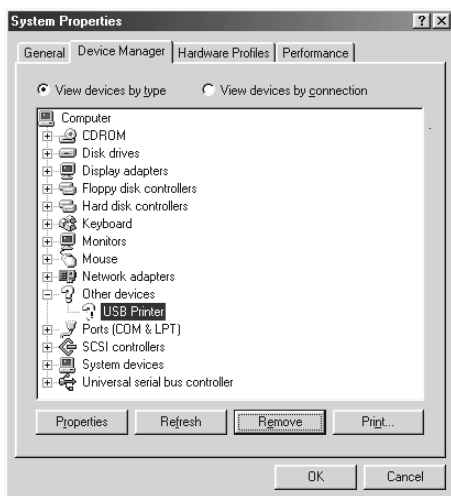

When the following dialog box appears, click OK, then click OK to close the System Properties dialog box.



6. Uninstall the printer software as explained in “Uninstalling the printer driver” on page 9-13. Then turn off the printer, restart your computer, and reinstall the printer software as explained in the *Setup* sheet packed with your printer.

---

## **Cancelling Printing**

If you encounter problems while printing, you may need to cancel printing. To cancel printing, follow the instructions in the appropriate section below.

### **For Windows Me, 98 and 95 users**

It is possible to cancel printing using either the Progress Meter or EPSON Spool Manager. Refer to the appropriate section below.



## Using the Progress Meter

When you send a print job to the printer, the Progress Meter appears on your computer screen.

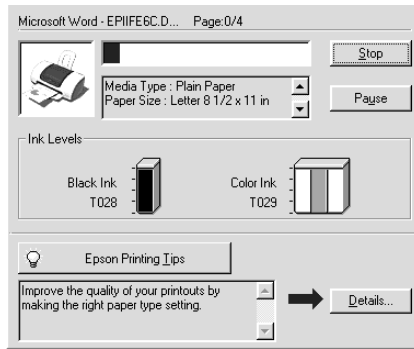

Click the Stop button to cancel printing.

## Using EPSON Spool Manager

EPSON Spool Manager is similar to Windows Print Manager. If it receives two or more print jobs at one time, it holds them in the order that they were received (with printers on a network this may be called a print queue). When a print job reaches the top of the line, the EPSON Spool Manager sends the job to the printer. From the Spool Manager, you can cancel print jobs. You can also view print status information about the print jobs which have been sent to your printer, as well as pause and resume or restart selected print jobs.

After you send a print job, an EPSON Stylus C60 Series button appears on the taskbar. Click this button to open the EPSON Spool Manager.

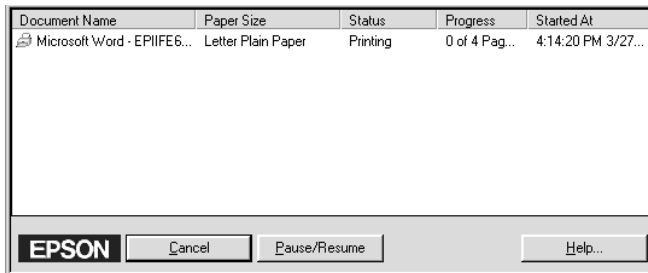

To cancel a print job, select the job in the list, then click Cancel.

## For Windows 2000 users

When you send a print job to the printer, the Progress Meter appears on your computer screen.

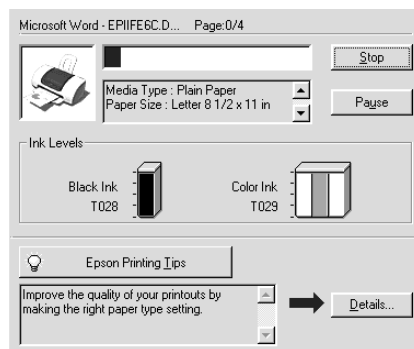

Click the Stop button to cancel printing.

## For Macintosh users

The procedure for canceling printing for Macintosh varies depending upon whether background printing is on or off. Refer to the appropriate section below.

### When background printing is on

Follow the steps below to cancel a print job.

1. Select EPSON Monitor3 from the application menu.
2. Press the  power button to turn off the printer.



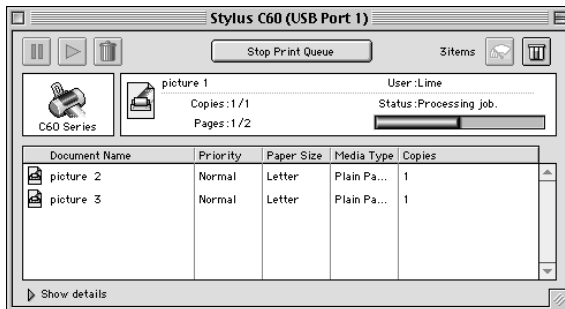

3. In the Document Name list, select the document which is printing, then click the  Stop icon button to cancel the print job.



### When background printing is off

Follow the steps below to cancel a print job.

1. Press the  power button to turn off the printer.
2. Hold down the  command key on your keyboard and press the period (.) key to cancel the print job.

---

# Options and Consumable Products

---

## Options

The following options are available for your printer.

### Interface cables

EPSON supplies the following interface cables for your printer. However, you can use any interface cable that meets these specifications. See your computer manual for any additional requirements.

- ❑ Parallel Interface Cable (shielded) C83602\* from D-SUB 25-pin (computer) to 36-pin Amphenol 57 Series (printer)
- ❑ USB Interface Cable (shielded) C83623\* from Series A 4-pin (computer) to series B 4-pin (printer).

**Note:**

- ❑ *The asterisk (\*) is a substitute for the last digit of the product number, which varies by location.*
- ❑ *Depending on your geographic location, this cable may not be supplied.*



**Caution:**

*Use only interface cables which meet the specifications listed above. Using other cables not covered by EPSON warranties may cause the printer to malfunction.*

---

## Consumable products

The following ink cartridges and EPSON special media are available for your printer.

### Ink cartridges

You can use the following cartridges with your printer.

Black ink cartridge	T028
Color ink cartridge	T029

**Note:**

*The product numbers of ink cartridges may vary by location.*

### Media types

EPSON offers specially-designed media for ink jet printers to meet most high-quality printing needs.

**Note:**

*For the latest information on media available in your area, contact EPSON customer services. See "Regional Customer Services" on page B-1 for details.*

## **Plain Paper**

EPSON Premium Ink Jet Plain Paper (A4)	S041214
EPSON Bright White Ink Jet Paper (A4)	S041442

## **360 dpi Ink Jet Paper**

EPSON 360 dpi Ink Jet Paper (A4)	S041059 S041025
EPSON 360 dpi Ink Jet Paper (Letter)	S041060 S041028
EPSON Iron-On Cool Peel Transfer Paper (A4)	S041154
EPSON Iron-On Cool Peel Transfer Paper (Letter)	S041153 S041155

## **Photo Quality Ink Jet Paper**

EPSON Photo Quality Ink Jet Paper (A4)	S041061 S041026
EPSON Photo Quality Ink Jet Paper (Letter)	S041062 S041029
EPSON Photo Quality Ink Jet Paper (Legal)	S041067 S041048
EPSON Photo Quality Ink Jet Card (A6)	S041054
EPSON Photo Quality Ink Jet Card (5 × 8")	S041121
EPSON Photo Quality Ink Jet Card (8 × 10")	S041122
EPSON Photo Quality Self Adhesive Sheet (A4)	S041106
EPSON Ink Jet Note Cards A6 (with envelopes)	S041147
EPSON Ink Jet Greeting Cards 5 × 8" (with envelopes)	S041148
EPSON Ink Jet Greeting Cards 8 × 10" (with envelopes)	S041149

## **Matte Paper-Heavyweight**

EPSON Matte Paper-Heavyweight (A4)	S041256 S041258 S041259
EPSON Matte Paper-Heavyweight (Letter)	S041257

## **Photo Paper**

EPSON Photo Paper (A4)	S041140
EPSON Photo Paper (Letter)	S041141
EPSON Photo Paper (4 × 6")	S041134
EPSON Photo Paper (100 × 150 mm)	S041255
EPSON Photo Paper (200 × 300 mm)	S041254
EPSON Panoramic Photo Paper (210 × 594 mm)	S041145
EPSON Photo Paper Cards (A4)	S041177

## **Photo Quality Glossy Film**

EPSON Photo Quality Glossy Film (A4)	S041071
EPSON Photo Quality Glossy Film (Letter)	S041072
EPSON Photo Quality Glossy Film (A6)	S041107
EPSON Photo Stickers 16 (A6)	S041144
EPSON Photo Stickers 4 (A6)	S041176

## **Ink Jet Transparencies**

EPSON Ink Jet Transparencies (A4)	S041063
EPSON Ink Jet Transparencies (Letter)	S041064



## **Premium Glossy Photo Paper**

EPSON Premium Glossy Photo Paper (A4)	S041287 S041297
EPSON Premium Glossy Photo Paper (Letter)	S041286
EPSON Premium Semigloss Photo Paper (A4)	S041332
EPSON Premium Semigloss Photo Paper (Letter)	S041331

**Note:**

*The availability of special media varies by location.*



# Printer Specifications

---

## Printing

---

Printing method	On-demand ink jet
Nozzle configuration	Monochrome (black) 144 nozzles Color (cyan, magenta, yellow) 144 nozzles (48 [each color] × 3)
Resolution	Maximum 2880 dpi × 720 dpi
Print direction	Bidirectional with logic seeking
Control code	EPSON/P Raster EPSON Remote
Input buffer	32 KB

---

## Paper

**Note:**

*Since the quality of any particular brand or type of paper may be changed by the manufacturer at any time, EPSON cannot attest to the quality of any non-EPSON brand or type of paper. Always test samples of paper stock before purchasing large quantities or printing large jobs.*

## **Paper specifications**

### Single sheets:

Size	A4 (210 mm × 297 mm) A5 (148 mm × 210 mm) Letter (216 mm × 279 mm) Half letter (139.7 mm × 215.9 mm) Legal (216 mm × 356 mm) Executive (184.2 mm × 266.7 mm)
Paper types	Plain bond paper, special paper distributed by EPSON
Thickness (for plain bond paper)	0.08 mm to 0.11 mm (0.003 to 0.004 inch)
Weight (for plain bond paper)	64 g/m <sup>2</sup> (17 lb) to 90 g/m <sup>2</sup> (24 lb)

### Envelopes:

Size	No. 10 (104.8 mm × 241 mm) DL (110 mm × 220 mm) C6 (114 mm × 162 mm) 132 mm × 220 mm
Paper types	Plain bond paper, air mail
Thickness	0.16 mm to 0.52 mm (0.006 to 0.02 inch)
Weight	45 g/m <sup>2</sup> (12 lb) to 75 g/m <sup>2</sup> (20 lb)

### Index Cards:

Size	A6 (105 mm × 148 mm) 5 × 8" (127 mm × 203 mm) 8 × 10" (203 mm × 254 mm)
Paper types	Special paper distributed by EPSON

### Transparencies, Glossy Film, Glossy Paper:

Size	A4 (210 mm × 297 mm) Letter (216 mm × 279 mm) A6 (105 mm × 148 mm) for glossy film
Paper types	Special paper distributed by EPSON

### Self Adhesive Sheets:

Size	A4 (210 mm × 297 mm)
Paper types	Special paper distributed by EPSON

### Photo Paper:

Size	A4 (210 mm × 297 mm) Letter (216 mm × 279 mm) Panorama (210 mm × 594 mm) 4 × 6" (113.6 mm × 175.4 mm) 100 mm × 150 mm 200 mm × 300 mm 113.6 mm × 175.4 mm
Paper types	Special paper distributed by EPSON

### Premium Glossy Photo Paper:

Size	Letter (216 mm × 279 mm) A4 (210 mm × 297 mm)
Paper types	Special paper distributed by EPSON

### Premium Semigloss Photo Paper:

Size	Letter (216 mm × 279 mm) A4 (210 mm × 297 mm)
Paper types	Special paper distributed by EPSON

### Photo Stickers:

Size	A6 (105 mm × 148 mm) with 4 or 16 frames
Paper types	Special paper distributed by EPSON

### Matte Paper-Heavyweight:

Size	A4 (210 mm × 297 mm) Letter (216 mm × 279 mm)
Paper types	Special paper distributed by EPSON

### **Note:**

- Poor quality paper may reduce print quality and cause paper jams or other problems. If you encounter problems, switch to a higher grade of paper.*
- Do not load curled or folded paper.*
- Use paper under normal conditions:  
Temperature 15 to 25°C (59 to 77°F)  
Humidity 40 to 60% RH*
- EPSON Photo Quality Glossy Film and Self Adhesive Sheets should be stored under the following conditions:  
Temperature 15 to 30°C (59 to 86°F)  
Humidity 20 to 60% RH*

## Printable area

Single sheets (including panoramic size) and index cards

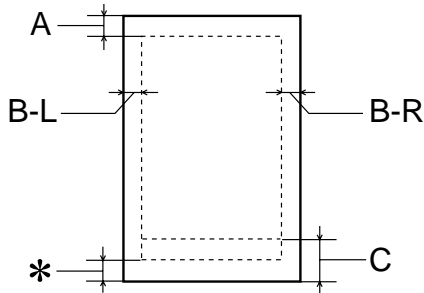

Envelopes

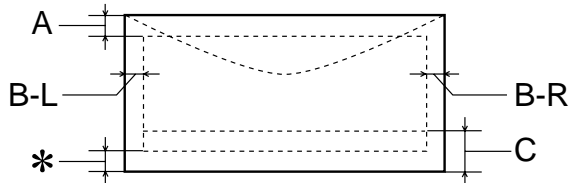

A: The minimum top margin is 3.0 mm (0.12").

When loading multiple sheets of EPSON Photo Quality Glossy Film, the minimum top margin is 30.0 mm (1.2").

B-L: The minimum left margin is 3.0 mm (0.12").

B-R: The minimum right margin is as follows:  
3.0 mm (0.12") for single sheets and C6 envelopes.  
7.0 mm (0.28") for DL envelopes.  
28.0 mm (1.10") for No. 10 envelopes.

- C: The minimum bottom margin is 14.0 mm (0.55").
- \*: You can extend the minimum bottom margin to 3 mm by selecting **MAXIMUM** as the Printable Area setting on the printer software's Paper menu (Windows) or in the Page Setup dialog box (Macintosh). However, print quality may decline in the expanded area. Before printing large jobs using this setting, print a single sheet to confirm printout quality.

**Note:**

*Always load paper into the sheet feeder short edge first. Load envelopes flap edge first with the flap side down.*



---

## **Ink Cartridges**

### **Black ink cartridge (T028)**

Color	Black
Print capacity*	600 pages/A4 (ISO/IEC 10561 Letter Pattern at 360 dpi)
Cartridge life	2 years from production date (within 6 months after opening package, at 25°C [77°F])
Temperature	Storage: -20 to 40°C (-4 to 104°F) 1 month at 40°C (104°F) Transit: -30 to 60°C (-22 to 140°F) 1 month at 40°C (104°F) 120 hours at 60°C (140°F) Freezing:** -16°C (3.2°F)
Dimensions	28.1 mm (W) × 66.85 mm (D) × 38.5 mm (H)

## Color ink cartridge (T029)

Color	Cyan, magenta, and yellow
Print capacity*	300 pages, 5% each CMY (Total 15%) in calculation
Cartridge life	2 years from production date (within 6 months of opening the package at 25°C [77°F])
Temperature	Storage: -20 to 40°C (-4 to 104°F) 1 month at 40°C (104°F) Transit: -30 to 60°C (-22 to 140°F) 1 month at 40°C (104°F) 120 hours at 60°C (140°F) Freezing:** -18°C (-0.4°F)
Dimensions	43.2 mm (W) × 66.85 mm (D) × 38.5 mm (H)

\* The figure given is based upon continuous printing after ink cartridge replacement. The actual print capacity may vary, depending on how often you use the print head cleaning function and how often you turn the printer on.

\*\* Ink thaws and is usable after approximately 3 hours at 25°C (77°F).



### **Caution:**

- ❑ *EPSON recommends the use of original EPSON ink cartridges only. Other products not manufactured by EPSON may cause damage to your printer not covered by EPSON's warranties.*
- ❑ *Do not use an ink cartridge if the date on the package has expired.*

---

## Mechanical

Paper feed method	Friction
Paper path	Sheet feeder, rear entry
Sheet feeder capacity	About 100 sheets at 65 g/m <sup>2</sup> (17 lb) paper
Dimensions	Storage Width: 479.6 mm (18.9 inches) Depth: 259.6 mm (10.2 inches) Height: 181.2 mm (7.1 inches)  Printing Width: 479.6 mm (18.9 inches) Depth: 450.6 mm (17.7 inches) Height: 271.8 mm (10.7 inches)
Weight	3.42 kg (7.5 lb) without the ink cartridges

---

## Electrical

	120 V Model	220-240 V Model
Input voltage range	99 to 132 V	198 to 264 V
Rated frequency range	50 to 60 Hz	
Input frequency range	49.5 to 60.5 Hz	
Rated current	0.4 A	0.2 A
Power consumption	Approx. 17 W (ISO10561 Letter Pattern) Approx. 4 W in standby mode	Approx. 17 W (ISO10561 Letter Pattern) Approx. 4.5 W in standby mode

**Note:**

*Check the label on the back of the printer for the voltage of your printer.*

---

## **Environmental**

Temperature	Operation: 10 to 35°C (50 to 95°F) Storage: -20 to 60°C (-4 to 140°F) 1 month at 40°C (104°F) Transit: * -20 to 60°C (-4 to 140°F) 120 hours at 60°C (140°F)
Humidity	Operation: 20 to 80% RH Storage: *, ** 5 to 85% RH

\* Stored in a shipping container

\*\* Without condensation

---

## **Standard and Approvals**

U.S. model:

Safety	UL 1950 CSA C22.2 No. 950
EMC	FCC Part 15 Subpart B Class B CSA C108.8 Class B

European model:

Low Voltage Directive  
73/23/EEC

EN 60950

EMC Directive  
89/336/EEC

EN 55022 Class B  
EN 55024  
EN 61000-3-2  
EN 61000-3-3

Australian model:

EMC

AS/NZS 3548 Class B

---

## **System Requirements**

Refer to the appropriate section below for the minimum and recommended computer system requirements necessary to use this printer.

### **For Windows computers**

To use your printer, you need Microsoft® Windows® Millennium Edition, Windows® 98, Windows® 95, or Windows® 2000 installed and the printer must be connected via a shielded, twisted-pair parallel cable. If you want to connect your printer to a USB port, you need a Windows 98 or Windows 2000 pre-installed PC equipped with a USB port and the printer must be connected via a standard, shielded USB cable.

Your computer should also meet the following system requirements.

Minimum System Requirements	Recommended System
-----------------------------	--------------------

Pentium 150 MHz processor for Windows Me Pentium for Windows 98 and 95 Pentium 133 MHz processor for Windows 2000	150 MHz or higher processor for Windows Me Pentium or higher processor for Windows 98 and 95 133 MHz or higher processor for Windows 2000
32 MB RAM for Windows Me 16 MB RAM for Windows 98 and 95 64 MB RAM for Windows 2000	64 MB RAM or more.
20 MB hard disk space for Windows Me, 98 and 95 40 MB hard disk space for Windows 2000	50 MB hard disk space or more for Windows Me, 98 and 95 100 MB hard disk space or more for Windows 2000
VGA monitor	VGA or better monitor

Your computer dealer can help you update your system if it does not meet these requirements.

## ***For Macintosh computers***

To connect this printer to Apple® Macintosh® computers, you must use a USB cable.

Your Macintosh must also meet the following system requirements.

<b>Minimum System Requirements</b>	<b>Recommended System</b>
Mac OS 8.1	Mac OS 9.0 or later
8 MB of available memory 8 MB of available memory when background printing is turned on.	19 MB of available memory or more 32 MB of available memory or more when background printing is turned on.

**Note:**

- ❑ *The amount of available memory varies according to the number and kind of applications that are open. To see how much memory is available, choose About This Computer from the Apple menu and refer to the memory size (listed in kilobytes) under “Largest Unused Block” (1,024K=1 MB).*
  
- ❑ *The memory requirements above are for printing on Letter size paper. These requirements may vary depending on the size of the paper, the type of application you are using, and the complexity of the document that you want to print.*

In addition to these system and memory requirements, you need 12 MB of free hard disk space to install your printer software. To print, you also need extra hard disk space amounting to about twice the size of the file that you want to print.





# Customer Support

---

## Technical Support Web Site

---

EPSON's Technical Support Web Site provides help with problems that cannot be solved using the troubleshooting information in your printer documentation. If you have a Web browser and can connect to the Internet, access that site at:

<http://support.epson.net/StylusC60>

## Regional Customer Services

---

If your EPSON product is not operating properly and you cannot solve the problem using the troubleshooting information in your product documentation, contact customer support services for assistance. If customer support for your area is not listed below, contact the dealer where you purchased your product.

Customer support will be able to help you much more quickly if you give them the following information.

- Product serial number  
(The serial number label is usually on the back of the product)
- Product model
- Product software version  
(Click About, Version Info, or similar button in the product software)
- Brand and model of your computer

- ❑ Your computer operating system name and version
- ❑ Names and versions of the software applications you normally use with your product

### ***For users in United States and Canada***

EPSON provides technical assistance 24 hours a day through the electronic support services and automated telephone services listed below. If you wish to speak directly to a technical support representative, see your *Printer Basics* book for contact information.

***Note:***

*For help using any other software on your system, see the documentation for that software for technical support information.*

### ***World Wide Web***

From the Internet, you can reach EPSON Support at <http://support.epson.com>. At this site, you can download drivers and other files, look at documentation such as product brochures and user manuals, and access troubleshooting information.

### ***EPSON Internet FTP Site***

If you have Internet FTP capability, use your Web browser (or other software for FTP downloading) to log onto <ftp.epson.com> with the user name `anonymous` and your e-mail address as the password.

### ***EPSON E-Mail Technical Support***

To receive technical advice through e-mail, go to <http://support.epson.com> and complete the form under the troubleshooting tab, as requested.

## *Automated Telephone Services*

A variety of automated help services are available 24 hours a day, seven days a week. To use these services, you must have a touch tone telephone and call (800) 922-8911.

## *EPSON Accessories*

You can purchase ink cartridges, paper, manuals, and accessories from EPSON at (800) 873-7766 or visit our web site at [www.epsonstore.com](http://www.epsonstore.com) (U.S. sales only). In Canada, please call (800) 873-7766 for dealer referral.

## ***For users in the United Kingdom and the Republic of Ireland***

If you purchased your product in the UK or the Republic of Ireland, EPSON (UK) LTD provides a range of customer services and technical support.

## *Support Via the World Wide Web*

- ❑ For information on the latest EPSON products, software drivers, online user guides, and answers to frequently asked questions:

<http://www.epson.co.uk>

- ❑ To e-mail EPSON Technical Support:

<http://www.epson.co.uk/support/email/>

- ❑ For a full list of EPSON Customer and Warranty Support services:

<http://www.epson.co.uk/support/>

## *Support Via Telephone*

Our Customer and Warranty Support teams can be contacted by calling 0870 163 7766 in the UK or 0044 0870 163 7766 from the Republic of Ireland. They can provide the following services:

- ❑ Technical information on installing, configuring, and operating your EPSON products
- ❑ Arranging for faulty EPSON products to be repaired within the warranty period

### *Pre-Sales Enquiry Desk*

Our Enquiry Desk team can be contacted by calling 0800 220546 in the UK or 1 800 409132 from the Republic of Ireland, by faxing 01442 227271 in the UK or 0044 1442 227271 from the Republic of Ireland, and via e-mail at [info@epson.co.uk](mailto:info@epson.co.uk). They can provide the following information:

- ❑ Pre-sales information and literature on new EPSON products (also available via our world wide web site at <http://www.epson.co.uk>)
- ❑ Where to purchase genuine EPSON consumables, accessories, and options

### **For users in Australia**

EPSON Australia wishes to provide you with a high level of customer service. In addition to your product documentation, we provide the following sources for obtaining information:

#### *Your Dealer*

Don't forget that your dealer can often help identify and resolve problems. The dealer should always be the first call for advise on problems, they can often solve problems quickly and easily as well as give advise on the next step to take.

#### *Internet URL <http://www.epson.com.au>*

Access the EPSON Australia World Wide Web pages. Worth taking your modem here for the occasional surf! The site provides a download area for drivers, EPSON contact points, new product information and technical support (e-mail).

## *EPSON Faxback service*

EPSON Faxback service will fax you the latest specifications for most EPSON products offered in Australia. Phone (02) 9903 9075 and the system will guide you through a number of choices before faxing the information to your fax machine.

## *EPSON Helpdesk*

EPSON Helpdesk is provided as a final backup to make sure our clients have access to advice. Operators on the Helpdesk can aid you in installing, configuring and operating your EPSON product. Our Pre-sales Helpdesk staff can provide literature on new EPSON products and advise where the nearest dealer or service agent is located. Many types of queries are answered here.

The Helpdesk numbers are:

Phone: 1300 361 054

Fax: (02) 9903 9189

We encourage you to have all the relevant information on hand when you ring. The more information you prepare, the faster we can help solve the problem. This information includes your EPSON product documentation, type of computer, operating system, application programs and any information you feel is required.

## ***For users in Malaysia***

Contacts for information, support, and services are:

*World Wide Web* ([www.epson.com.my](http://www.epson.com.my))

Information on product specifications, drivers for download, Frequently Asked Questions (FAQ), and e-mail enquiries are available.

## *Epson Trading Shah Alam Head Office*

Phone: 03 5191366

Fax: 03 5191281

### ***For users in Singapore***

Sources of information, support, and services available from Epson Singapore are:

*World Wide Web ([www.epson.com.sg](http://www.epson.com.sg))*

Information on product specifications, drivers for download, Frequently Asked Questions (FAQ), Sales Enquiries, and Technical Support via e-mail are available.

*Epson HelpDesk [Phone: (065) 5863111]*

Our HelpDesk team can help you with the following over the phone:

- Sales enquiries and product information
- Product usage questions or problem
- Enquiries on repair service and warranty

### ***For users in India***

Contacts for information, support, and services are:

*World Wide Web ([www.epson.co.in](http://www.epson.co.in))*

Information on product specifications, drivers for download, Frequently Asked Questions (FAQ), Products Enquiry, and Technical Query are available.

## *Epson India Bangalore Head Office:*

Phone: 5321 266-70  
Fax: 5581799/5321095  
Help Desk Phone: -5321 625

## ***For users in the Philippines***

To obtain technical support as well as other after sales services, users are welcome to contact the EPSON Philippines Representative Office at the telephone and fax numbers below:

Phone: (632) 813-6552  
Fax: (632) 813-6545  
BBS: (632) 814-0595

## ***For users in Hong Kong***

To obtain technical support as well as other after-sales services, users are welcome to contact EPSON Hong Kong Limited.

## *Internet home page*

EPSON Hong Kong has established a local home page in both Chinese and English on the Internet to provide users with the following information:

- Product information
- Answers to Frequently Asked Questions (FAQs)
- Latest versions of EPSON product drivers

Users can access our World Wide Web home page at:

<http://www.epson.com.hk>

### *Electronic bulletin board system*

An electronic bulletin board system (BBS) is also available to obtain product information and the latest versions of product drivers. You can log on to the following number for the BBS service:

BBS: (852) 2827-4244

### *Technical Support Hotline*

You can also contact our technical staff at the following telephone and fax numbers:

Phone: (852) 2585-4399

Fax: (852) 2827-4383



---

# Glossary

The following definitions apply specifically to printers.

**application**

Software that helps you carry out a particular task, such as word processing or financial planning.

**ASCII**

American Standard Code for Information Interchange. A standardized coding system for assigning numerical codes to letters and symbols.

**banding**

The horizontal lines that sometimes appear when printing graphics. This occurs when the print head is misaligned. See also *MicroWeave*.

**bit**

A binary digit (0 or 1), which is the smallest unit of information used by a printer or computer.

**brightness**

The lightness or darkness of an image.

**buffer**

The portion of the printer's memory used to store data before printing it.

**byte**

A unit of information consisting of eight bits.

**characters per inch (cpi)**

A measure of the size of text characters, sometimes referred to as pitch.

**CMYK**

Cyan (blue-green), magenta, yellow, and black. These colored inks are used to create the subtractive system array of printed colors.

**color matching**

A method of processing color data so that colors displayed on a computer screen closely match colors in printouts. A variety of color-matching software is available.

**ColorSync**

Macintosh software that is designed to help you get WYSIWYG (what you see is what you get) color output. This software prints colors as you see them on your screen.

**cpi**

See *characters per inch (cpi)*.

**default**

A value or setting that takes effect when the equipment is turned on, reset, or initialized.

**dithering**

A halftoning method in which dots are arranged in an orderly pattern. Dithering works best when printing images with solid colors, such as charts and graphs.

**DMA**

Direct Memory Access. A data transfer feature that bypasses a computer's CPU and allows direct communication between a computer and peripheral devices (like printers), and between one peripheral device and another.

**dpi**

Dots per inch. The dpi measures the resolution. See also *resolution*.

**drive**

A memory device, such as a CD-ROM, hard disk, or floppy disk drive. In Windows, a letter is assigned to each drive for easy management.

**driver**

Software that sends instructions to a computer peripheral to tell it what to do. For example, your printer driver accepts print data from your word processor application and sends instructions to the printer on how to print this data. Together, the printer driver and printer utilities are referred to as "printer software". See also *printer software*.

**economy printing**

Printing in which images are printed with fewer dots to save ink.

**error diffusion**

Error diffusion blends individual colored dots with the colors of the surrounding dots to create the appearance of natural colors. By blending colored dots, the printer can achieve excellent colors and subtle color gradation. This method is best suited for printing documents that contain detailed graphics or photographic images.

**ESC/P**

Abbreviation for EPSON Standard Code for Printers, the system of commands your computer uses to control your printer. It is standard for all EPSON printers and is supported by most applications for personal computers.

**ESC/P 2**

The enhanced version of the ESC/P printer command language. Commands in this language produce laser-like features, such as scalable fonts and enhanced graphics printing.

**Finest detail**

This printer software setting automatically makes your printouts sharper and clearer, especially for text. Be aware that this may increase the time required for printing.

**font**

A style of type designated by a family name.

**grayscale**

A scale of shades of gray from black to white. Grayscale is used to represent colors when printing with black ink only.

**halftones**

Patterns of black or colored dots used to reproduce an image.

**high speed printing**

Printing in which the print head prints images in both directions as it moves back and forth. This provides faster printing.

**ICM (Image Color Matching)**

The color matching method used by Windows Me, 98, 95, and 2000 to match the colors in your printout with the colors displayed on your screen.

**initialization**

Returns the printer to its defaults (fixed set of conditions). This happens every time you turn on the printer or reset the printer.

**ink cartridge**

Contains the ink that your printer uses to print.

**ink jet**

A method of printing in which each letter or symbol is formed by precisely spraying ink onto paper.

**interface**

The connection between the computer and the printer. A parallel interface transmits data one character or code at a time. A serial interface transmits data one bit at a time.

**interface cable**

The cable that connects the computer to the printer.

**local printer**

The printer connected to the computer's port directly by an interface cable.

**media**

Materials upon which data is printed, such as envelopes, plain paper, special paper, and transparency film.

**memory**

The part of the printer's electronic system that is used to store information (data). Some information is fixed and is used to control how the printer operates. Information that is sent to the printer from the computer is stored in memory temporarily. See also *RAM* and *ROM*.

**MicroWeave**

Printing in which images are printed in finer increments to reduce the possibility of banding and to produce laser-like images. See also *banding*.

**monochrome**

Printing which uses only one color of ink, usually black.

**nozzles**

Fine tubes in the print head through which ink is sprayed onto the page. Print quality may decline if the print head nozzles are clogged.

**operation check**

A method for checking the operation of the printer. When you perform a printer operation check, the printer prints the ROM version, code page, ink counter code, and a nozzle check pattern.

**parallel interface**

See *interface*.

**port**

An interface channel through which data is transmitted between devices.

**printable area**

The area of a page on which the printer can print. It is smaller than the physical size of the page due to margins.

**printer driver**

See *driver*.

**printer software**

The printer software which comes with your printer includes a printer driver and printer utilities. The printer driver lets you choose from a wide variety of settings to get the best results from your printer. The printer utilities help you check the printer and keep it in top operating condition. See also *driver* and *utilities*.

**printer utilities**

See *utilities*.

**print queue**

When your printer is connected to a network, a waiting line in which print jobs that are sent to the printer while it is busy are stored until they can be printed.

**RAM**

Random Access Memory. The portion of the printer's memory used as a buffer and for storing user-defined characters. All data stored in RAM is lost when the printer is turned off.

**reset**

To return a printer to its defaults by turning the printer off and then back on.

**resolution**

The number of dots per inch used to represent an image.

**ROM**

Read Only Memory. A portion of memory that can only be read and cannot be used for data storage. ROM retains its contents when you turn off the printer.

**RGB**

Red, green, and blue. These colors, in phosphors irradiated by a cathode ray tube (CRT) monitor's electron gun, are used to create the additive array of screen colors.

**serial interface**

See *interface*.

**Smooth Edge**

Improves the print quality of lower-resolution images by smoothing jagged edges and lines. This setting has no effect on high-resolution images or on text.

**spool**

The first step in printing, in which the printer software converts the print data into codes that your printer understands. This data is then sent directly to the printer or to the print server.

**spool manager**

The software that converts print data into codes that your printer understands. See also *spool*.

**sRGB**

The color management method used to maintain color consistency between devices which adhere to the sRGB standard.

**Status Monitor**

The software that allows you to check the printer's status.

**subtractive colors**

Colors produced by pigments that absorb some colors of light and reflect others. See also *CMYK*.

**USB interface**

Universal Serial Bus interface. Enables the user to connect up to 127 peripheral devices (such as keyboards, mice, and printers) to the computer through a single, general-purpose port. The use of USB hubs allows you to add additional ports. See also *interface*.

**utilities**

Software that allows you to monitor and maintain your printer. Together, utilities and the printer driver are referred to as "printer software". See also *printer software*.

**WYSIWYG**

What-you-see-is-what-you-get. This term is used to describe printout that looks exactly like it appears on screen.

