

EPSON®

M M PROJECTOR
ULTRA EDIA

EMP-7600/5600™

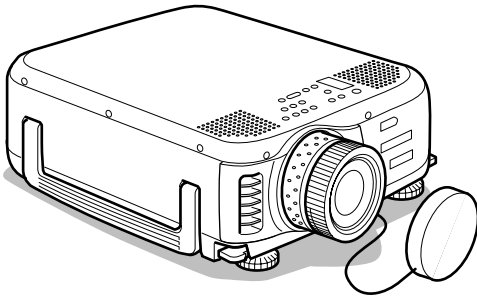

Before use

Installation

Connections

Projection

Useful Functions

Adjustments and
setting

Troubleshooting







Maintenance

Others

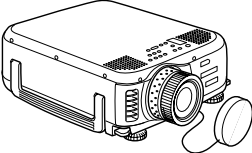
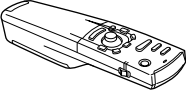
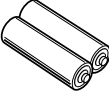
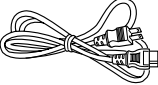
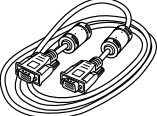
Owner's Manual

Accessory Verification

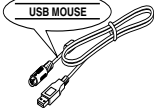
Check to confirm that the following items are included in the package when removing the projector and accessories from the box. Contact your dealer if any items are found to be missing.

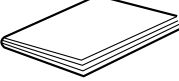
<ul style="list-style-type: none">· Projector Lens Cover with string 	<ul style="list-style-type: none">· Remote Control 	<ul style="list-style-type: none">· 2AA Batteries for the remote control (three-cell alkaline manganese batteries) 	
<ul style="list-style-type: none">· Power Cord 	<ul style="list-style-type: none">· Computer Cable 	<ul style="list-style-type: none">· Audio Cable 	<ul style="list-style-type: none">· RCA Audio Cable (Yellow) 
<ul style="list-style-type: none">· RCA Audio Cable (Red/White) 	<ul style="list-style-type: none">· USB Mouse Cable 	<ul style="list-style-type: none">· PS/2 Mouse Cable 	<ul style="list-style-type: none">· Owner's Manual (this document) 

■ Features

- **Crystal clear screen**

Clarity has been vastly improved.

Provides crystal clear projections even in bright areas, perfect for presentation purposes.

- **Wide range of display resolution**

Uses a high-resolution liquid-crystal panel.

EMP-7600 : 1024×768

EMP-5600 : 800×600

- **Compact and light**

A compact body makes it easy for carrying around.

(Approximately 6.8kg, 14.9 litres)

- **DVI-D* port that supports digital output**

Fitted with a DVI-D Port for digital input purposes. This can also be connected to a computer's digital output port.

■ Contents

Accessory Verification	1
-------------------------------	----------

Features	1
-----------------	----------

Contents	2
-----------------	----------

Using this manual	7
--------------------------	----------

Symbol displays	7
-----------------------	---

Safety Precautions	8
---------------------------	----------

Before using this equipment	13
------------------------------------	-----------

Parts, Names and Operations	13
------------------------------------	-----------

Projector	13
-----------------	----

Remote Control	18
----------------------	----

Range of Remote Control Operations	21
--	----

Inserting the Remote Control Batteries	22
--	----

Installation	23
---------------------	-----------

Installation Procedure	23
-------------------------------	-----------

Installation example	23
----------------------------	----

Screen size and projection distance	24
---	----

Projection angles	25
-------------------------	----

Connections	26
--------------------	-----------

Connecting the projector to a computer	26
---	-----------

Eligible computers	26
--------------------------	----

In the case of the Computer1 port (mini D-sub 15-pin)	29
---	----

In the case of the Computer2/Component Video port	31
---	----

In the case of DVI-D*	32
-----------------------------	----

Sound connection	33
Connecting external audio equipment	34
Connecting the mouse (wireless mouse function)	35

Connecting the video equipment **37**

In the case of composite image signals	37
In the case of S image signals	37
In the case of component (color differential*) image signals	38
In the case of the digital tuner's D output port	39
In the case of RGB image signals	40

Projecting **41**

Projection **41**

Preparations	41
Commencing projection	42

Ending **45**

Adjusting the Projection Position **47**

Feet adjustments	47
------------------------	----

Adjusting the Projection Size **48**

Zoom adjustment	48
Keystone adjustment	49

Picture Quality Adjustment **50**

Focus adjustment	50
Auto adjustment (when projecting computer images)	50
Tracking adjustments (when projecting computer images)	51
Synchronization adjustments (when projecting computer images)	51
Calling out adjustment values (when projecting computer images)	51

Introduction of Functions	52
----------------------------------	-----------

Useful Functions	53
-------------------------	-----------

Useful Functions	53
-------------------------	-----------

Help Function	53
---------------------	----

Projection Cutting	55
---------------------------	-----------

A/V Mute Function	55
-------------------------	----

Freeze Function	55
-----------------------	----

Switching Image Sizes	56
------------------------------	-----------

Enlarging Images (E-Zoom function)	57
---	-----------

Effect Function	58
------------------------	-----------

Cursor/Stamp	58
--------------------	----

Box	58
-----------	----

Spotlight	59
-----------------	----

Bar	60
-----------	----

Canceling effects	60
-------------------------	----

P in P Function	61
------------------------	-----------

Adjustments and Settings	62
---------------------------------	-----------

Volume Adjustment	62
--------------------------	-----------

Menu Configuration	63
---------------------------	-----------

Menu items	63
------------------	----

Menu Operations	65
------------------------	-----------

Operation method	65
------------------------	----

Setting items	67
---------------------	----

User logo registration	72
------------------------------	----

Troubleshooting **74**

Troubleshooting **74**

Operation Indicator	74
Lamp Indicator	75
Temperature Indicator	76

When the Indicators provide No Help **77**

The image is not projected	77
The image is unclear	79
The image is cut up (Large)/Small	81
The image color is bad	81
The image is dark	82
No sound	82
The remote control will not work	83
Cannot end (after the [Power] button has been pressed) ..	83

Maintenance **84**

Cleaning the Projector, Cleaning the Lens, Cleaning the Air Filter **84**

Cleaning the projector	85
Cleaning the lens	85
Cleaning the Air Filter	85

Replacing the Air Filter **86**

Replacement method	86
--------------------------	----

Replacing the Lamp **87**

Replacement method	88
Resetting the lamp illumination time	89

Others **90**

Optional Parts **90**

Transportation	91
Terminology	92
Specifications	94
Check Sheet	95
World-Wide Warranty Terms	97
Index	101

■ Using this manual

Symbol displays

A variety of pictures displays have been used in this manual and on the actual product to ensure that the projector is used correctly and safely in order to prevent risks to users and other people, and to prevent damage to property. Explanations for these displays are provided below. Ensure that they are fully understood before reading this manual.

 **Warning**

Displays details that may result in death or injury if ignored.

 **Caution**

Displays details that may result in injury or damage to property if ignored.

Point: Includes supplementary explanations and useful tips.

Reference: Indicates reference pages

*: Refer to the terminology

· Usage of the terms “this unit” and “this projector” in this manual

The terms “this unit” and “this projector” appear regularly in this manual, and these terms also cover the accessories supplied with the projector and other optional products.

· The projection distances, illustrations and screen sizes apply to when the standard lens is in use.

■ Safety Precautions

Read and observe the following safety precautions to ensure safe use of the equipment.

⚠ Warning

- **If any of the following abnormalities occur, switch off the power supply immediately, remove the plug from the power socket and contact your dealer or nearest address provided at page 97.**

- The emission of smoke, strange odors or strange noises.
- Faults, such as images not being able to be projected or no sound being emitted.
- When water or foreign objects have entered the inside of the unit.
- When the unit has been dropped or the case damaged.

Continuation of operations under these conditions may result in the outbreak of fire or electric shocks.

Repairs should never be attempted by the user.

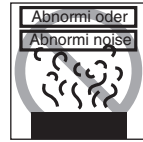

- **The cabinet to the unit should never be opened by anyone other than our service personnel.**

The inside of the projector contains many high-voltage parts that may result in the outbreak of fire, electric shocks or other incidents.



- **Never use an electrical voltage other than that displayed.**

The use of a voltage other than that specified may result in the outbreak of fire or electric shocks.



- **Verify the specifications of the Power Cord.**

The Power Cord supplied with the projector conforms to the electrical specifications of the country of purchase. If the projector is to be used in any other location, check the electrical voltage and shape of sockets in the relevant country beforehand and purchase a cable that conforms to that country's specifications.

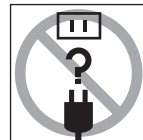

- **Never use damaged Power Cord.**

Failure to observe this may result in the outbreak of fire or electric shocks. Also ensure that the following points are strictly observed.

- Never make any modifications to the Power Cord.
- Never place anything heavy on the Power Cord.
- Never bend, twist or pull the cable.
- Ensure that the cable is not installed near heaters.

Contact your dealer or nearest address provided at page 97 if the power cord becomes damaged.

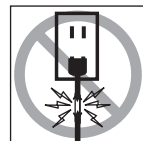

⚠ Warning

- **Never look into the lens when the power is switched on.**

An extremely strong light is emitted that may cause sight defects. Special attention must be paid by households with children.



- **Take care when handling power plugs and power connectors.**

Failure to observe these instructions may result in the outbreak of fire or electric shocks.

Observe the following precautions when handling power plugs and power connectors.

- Never connect too many appliances to a single socket.
- Never use plugs or connectors to which dust, dirt or other foreign objects have adhered.
- Ensure that the plugs and connectors are firmly inserted as far as they will go.
- Do not attempt to plug in plugs or connectors with wet hands.
- Do not pull the Power Cord when disconnecting plugs and connectors. Always ensure that the actual plug or connector is firmly gripped.



- **The projector includes many glass parts, such as the lens and lamps.**

If any of these parts should break, handle them with extreme care to avoid injury and then contact your dealer or nearest address provided at page 97 and request repairs.



- **Never place vases or containers that contain liquid on top of the projector.**

If the water is spilt and enters the outer case, it may result in the outbreak of fire or electric shocks.



- **Never insert or drop metal or inflammable objects, or any other foreign objects into the suction inlets and ventilation outlets on the projector.**

Failure to observe this may result in the outbreak of fire or electric shocks.



- **Never place the projector or the battery-operated remote control in locations with excessive temperatures, such as in vehicles with closed windows, in areas subject to direct sunlight, or near the fan outlets of air-conditioners and heaters.**

Failure to observe this may result in heat-distortion that would have an adverse affect on the contents of the projector, and may result in the outbreak of fire or electric shocks.



- **Do not block or look inside the main unit's ventilation outlet.**

Failure to observe this may result in injury through glass shreds if the lamp is broken.

⚠ Caution

- **Never stand on the projector or place any heavy objects on it.**

Failure to observe this may result in it dropping over, becoming damaged, or causing injury.



- **Never place the projector on unstable surfaces, such as wobbly tables or slanted surfaces.**

Failure to observe this may result in it dropping over, becoming damaged, or causing injury.



- **Do not place or store the projector within the reach of children's hands.**

Failure to observe this may result in it dropping over, becoming damaged, or causing injury.



- **Do not place the projector in humid or dusty locations, or in locations where it would be subject to oil steam or water steam, such as kitchens or near humidifiers.**

Failure to observe this may result in the outbreak of fire or electric shocks.



- **Never block the projector's suction inlets or ventilation outlets. Failure to observe this may result in the build up of high temperatures inside the projector, leading to the outbreak of fire. Do not place the projector in the following locations.**

- In narrow, badly ventilated areas, such as in cupboards or in bookcases.
- On top of carpets, mattresses or blankets.
- Never cover the projectors with table cloth or other material.

Also, if placing by a wall, ensure that at least 20cm of space has been provided between the projector and the wall.

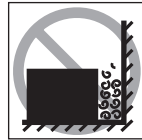

- **Always ensure that the plug has been disconnected from the power socket when it is not to be used.**

Failure to observe this may result in the outbreak of fire.

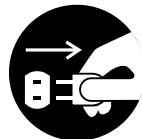

- **Always ensure that the power has been switched off, the plug has been disconnected from the power socket, and all other cables have been disconnected when moving the projector.**

Failure to observe this may result in the outbreak of fire or electric shocks.

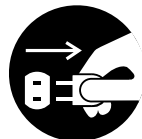

⚠ Caution

- **Never attempt to remove the lamp immediately after the projector has been used. Wait for the projector to cool down sufficiently by leaving it for at least sixty minutes after the power supply has been switched off.**

Failure to observe this may result in burns or other injuries.

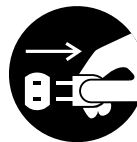

- **Misuse of the batteries may result in damage to the batteries and subsequent leakages, leading to the outbreak of fire, injury and product corrosion. Observe the following precautions to ensure safety.**

- Never use combinations of different batteries, or old batteries together with new batteries.
- Never use batteries that are not specified in the instruction manual.
- If liquid should leak from the battery, wipe up the leakage with a cloth and then replace the battery accordingly.
- Replace the batteries immediately when the time for replacement arrives.
- Remove the batteries when the projector is not to be used for a long period of time.
- Never apply heat to the batteries, or place them in naked flames or water.
- Ensure that the batteries are inserted in accordance with the correct polarity (+ and -).
- If any liquid that has leaked from a battery gets onto the hands, wash it off immediately with water.

Batteries must be disposed of in accordance with the regulations in effect in each relevant area.

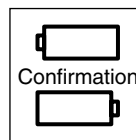

- **Ensure that the electric plug and connectors have been disconnected from their sockets when performing maintenance tasks.**

Failure to observe this may result in electric shocks.

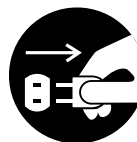

Safety Precautions

- **Using the projector outside of the permissible temperature range (+5C° to 40C°) may result in unstable display and excessive loads being placed on the fan, leading to damage to the equipment.**
- **Storing the projector outside of the permissible temperature range (-10C° to 60C°) may result in damage of the case. Take special care to avoid placing the equipment in direct sunlight for a long period of time.**
- **Do not use the projector with the lens cover still in place. The heat generated by the lens may cause the cover to become malformed.**
- **The liquid crystal display panel has been manufactured with high-accuracy technology and contains more than 99.99% active pixels. However, note that there is a possibility of 0.01% of missing pixels and pixels that will be constantly illuminated.**

Before using this equipment

This section provides explanations on parts and part names, and the items that should be verified before operating the remote control.

■ Parts, Names and Operations

Projector

● Front Panel

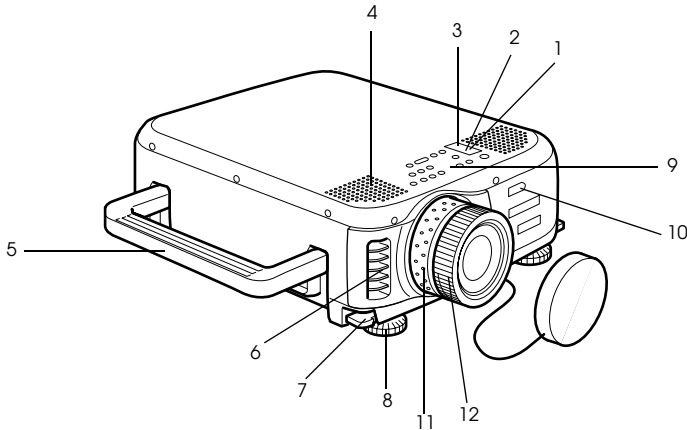

- 1 Operation Indicator
- 2 Lamp Indicator
- 3 Temperature Indicator
- 4 Speaker
- 5 Handle
- 6 Ventilation Outlet
- 7 Foot Adjust Lever
- 8 Front Foot
- 9 Operation Panel
- 10 Remote Control Receiver
- 11 Zoom Ring
- 12 Focus Ring

● **Side Panel**

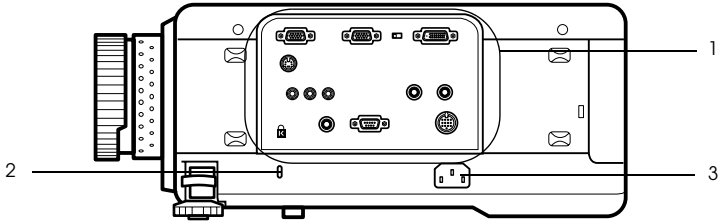

1 I/O Port

2 Theft-protection lock (see page 93)

3 Power Inlet

● **Back Panel**

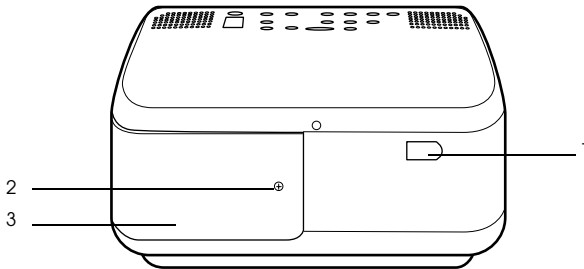

1 Remote Control Receiver

2 Screw holding the lamp cover

3 Lamp Cover

● **Rear Panel**

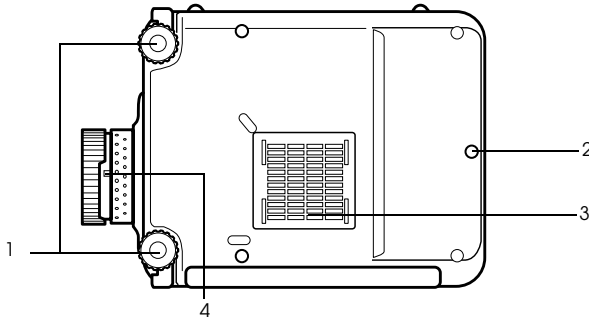

1 Front Foot

2 Rear Foot

3 Air Filter (suction inlet)

4 Lens Removal Lever

· This lever is only to be used when replacing the lens with optional attachment lenses.

● **Operation Panel**

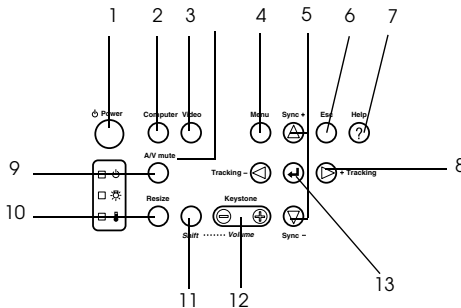

1 [Power] button (see page 42, 45)

Switches the power supply on and off.

2 [Computer] button (see page 43)

Switches between Computer #1 images and computer #2 (computer image or RGB image) images.

3 [Video] button (see page 43)

Switches the images between video images (Video), S video (S-Video) and component video (YCbCr, YPbPr).

4 [Menu] button (see page 65)

Displays and cancels the menu.

5 [Sync] button (see page 51)

Makes the necessary adjustments when the screen is out of focus or flickering. This button functions as the up and down key when the menu or help text are being displayed.

6 [Esc] button (see page 66)

Ends functions that are currently in use. Returns the screen to the previous stage when this is pressed during menu and help text display.

7 [Help] button (see page 53)

Displays the methods of solving problems. Press this button when trouble occurs.

8 [Tracking] button (see page 51)

Performs the necessary adjustments when stripes appear on the screen. Moves left and right when this is pressed during menu and help text display.

9 [A/V mute] button (see page 55)

Temporarily erases the image and sound. Projection is resumed when this button is pressed once more or when the volume control is adjusted or when the menu is displayed. User logos can also be set up for projection when in the mute mode.

10 [Resize] button (see page 56)

Switches between the window display and the resizing display when computer images are being projected. Switches the aspect ratio between 4:3 and 16:9 when video images are being projected.

11 [Shift] button (see page 62)

Adjusts the volume when pressed simultaneously with the [Volume (Keystone)] button.

12 [Keystone] button (see page 49)

Performs the necessary adjustments when the screen distorts into a trapezoid shape.

13 [↵(Enter)] button (see page 50, 65)

- Sets the menu item and moves onto the lower stage.
- Optimizes the computer image when the menu or help text are not displayed. (Switches the input resolution across to [Auto] when set for [Manual]).

● I/O Ports

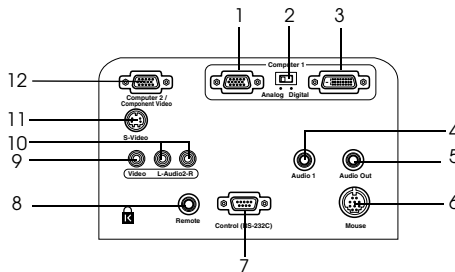

1 Computer #1 mini D-Sub 15 Port

Inputs the computer's analog image signals.

2 Change-over Switch

Switches the valid port for Computer #1 across to either mini D-Sub15 (analog) or DVI-D (digital). Operate the switch with the tip of a ballpoint pen or other pointed object.

- Be sure to set before inputting the signal.

3 Computer #1-DVI-D Port

Inputs the computer's digital image signals.

4 Audio1 Port

Inputs the sound signals from the computer or the A/V equipment connected to the Computer #1 port. The connection is made with a stereo mini-jack.

5 Audio Out Port

Outputs the projector's sound signals.

- When a cable is connected here, no audio will be output from the speakers on the projector main unit.

6 Mouse Port

Connected to the computer when the remote control is to be used as a wireless mouse.

7 Control (RS-232C) Port

Connected with a serial cable (RS-232C) available on the open market when the optional projector software is to be used with a computer.

8 Remote Port

Connects the optional remote control receiver (ELPST04).

9 Video Port

Inputs the A/V equipment's component image signals.

10 L-Audio2-R Port

Inputs the audio signals from A/V equipment and computers connected to the Video port, the S-Video port, and the Computer2/Component Video port.

11 S-Video Port

Inputs the A/V equipment's S image signals.

12 Computer #2 /Component Video Port

Inputs the computer's (second computer's) analog image signals, the A/V equipment's component signals (color -difference signals) and the RGB image signals.

Remote Control

● Front Panel

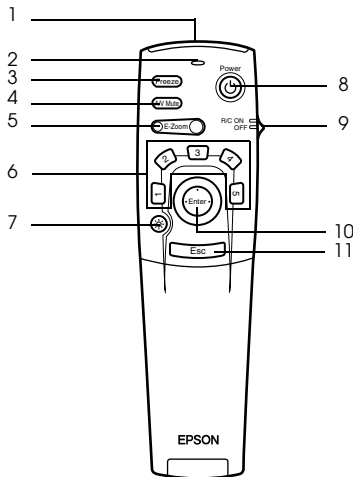

1 Remote control light-receiving area

Outputs the remote control unit's signals.

2 Indicator

Illuminated when the remote control unit signals are being output.

- The light will not be output if batteries are weak, or the switch is off.

3 [Freeze] button (see page 55)

Temporarily freezes the image. Press this button once more to cancel the freeze mode.

4 [A/V Mute] button (see page 55)

Temporarily erases the images and sound. Projection will be resumed if this button is pressed once more or the volume is adjusted.

5 [E-Zoom] button (see page 57, 61)

Enlarges and reduces the image. Enlarges the sub-screen when using P in P images. Press the [Esc] key to cancel this mode.

6 [Effect] button (see page 58)

Executes the allocated effect function. Press the [Esc] key to cancel this mode.

7 [(Light)] button

The remote control button will be illuminated for approximately ten seconds.

8 [Power] button (see page 42, 45)

Switches the power supply to the projector on and off.

9 [R/C ON OFF] switch (see page 42, 46)

Switches the remote control unit on and off. The remote control unit cannot be used for operations when this switch is not set at [ON].

10 [Enter] button (see page 36, 65)

- Sets the menu item when pressed, and then moves onto the lower stage. Becomes a cursor key to select the menu items when moved up, down, left or right.
- This function operates as a left-hand click on the mouse when computer images are being projected. The pointer will move when this button is moved up, down, left or right.

11 [Esc] button (see page 36, 66)

- Ends the function being used. Returns to the previous stage when the menu or help text is being displayed.
- This function operates as a right-hand click on the mouse when computer images are being projected.

● Inside of the Cover

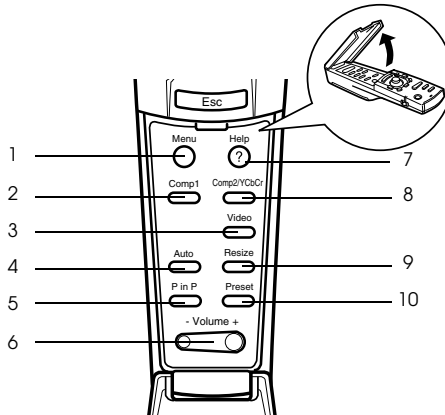

1 [Menu] button (see page 65)

Displays and ends the menu.

2 [Comp1] button (see page 43)

Switches to the image from computer 1 port. Switches to the DVI-D image when the switch is set to Digital (right-hand position).

3 [Video] button (see page 43)

Switches between video images (Video) and S-video images (S-Video).

4 [Auto] button (see page 50)

Optimizes the computer image.

5 [P in P] button (see page 61)

Displays the video image within the computer image or the video image as a sub-screen. This function is cancelled by pressing this button once again.

6 [Volume] button (see page 62)

Adjusts the volume.

7 [Help] button (see page 53)

Displays the method of solving problems. Press this button when trouble occurs.

8 [Comp2/YCbCr] button (see page 43)

Switches between the images from the Computer2/Component Video port.

9 [Resize] button (see page 56)

Switches between the window display and the resizing display when computer images are being projected. Switches the aspect ratio between 4:3 and 16:9 when video images are being projected.

10 [Preset] button (see page 51)

Calls out the preset computer input settings.

● **Rear Panel**

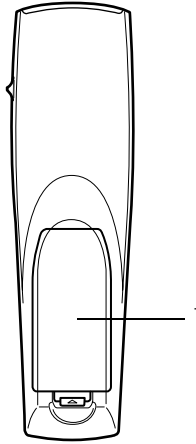

1 Battery Cover

Range of Remote Control Operations

Depending on the distance and angle from the main unit's light receiving area, there are cases where the remote control will not function. Ensure that the remote control is used within the following conditions:

- **Operable distance: Approximately 10 meters**
- **Operable range:**

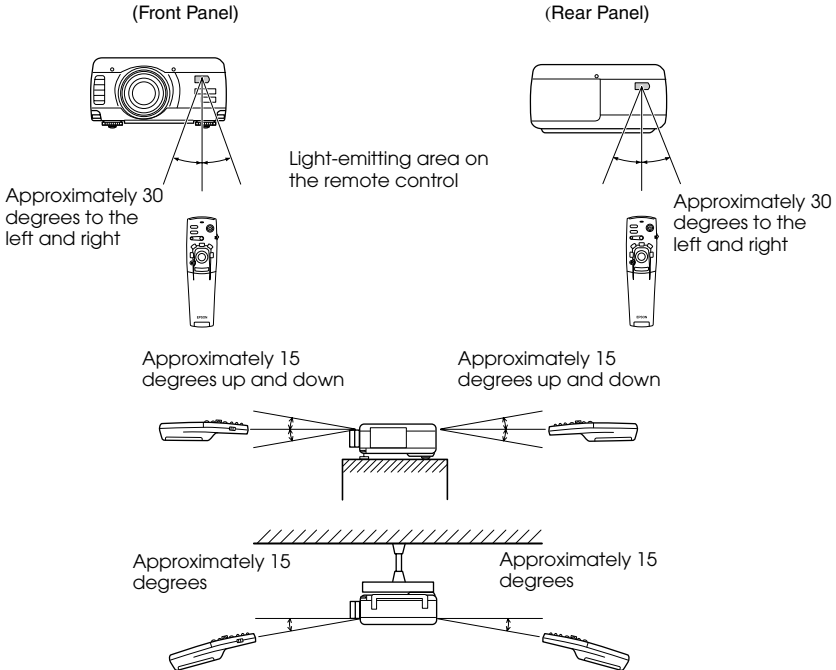

Point

- Ensure that the [R/C ON OFF] switch is set at [ON] when using the remote control unit.
- Aim the remote control at the projector's light-receiving area.
- There are cases where the operable distance (approximately 10 meters) of the remote control is diminished when signals are reflected off screens depending on the type of screen in use.
- Ensure sunlight or florescent light does not affect the projector's light receiving area.
- If the remote control will not function or malfunctions, there is a possibility that the batteries need changing. In this event, replace the batteries accordingly.
- Use the optional remote control receiver (ELPST04) if it is to be used at a distance of 10m or more.

Inserting the Remote Control Batteries

The remote control batteries are inserted in accordance with the following procedure:

⚠ Caution

Ensure that unused batteries of the same type are used.

1 Remove the Battery Cover.

Apply pressure to the clip holding the Battery Cover, and then lift it upwards.

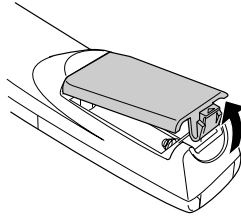

2 Insert the batteries.

Ensure that the batteries are aligned correctly with the “+” and “-” labels on the remote control.

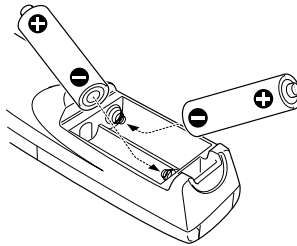

3 Replace the cover.

Apply pressure to the battery cover until it clicks firmly into place.

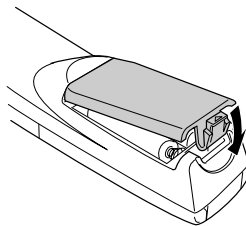

Point

- Specified batteries: Two three-cell alkaline manganese batteries (LR6).
 - The batteries should be replaced approximately once every three months when used for thirty minutes per day.
-

Installation

This section provides an example of projector installation, and explanations on the projection distances and projection angles.

■ Installation Procedure

Determines the projection angle and projection distance to ensure the most suitable screen display.

⚠ Caution

- Do not block the ventilation outlet on the front of the main unit or the air filter (suction inlet) on the rear of the main unit.
- There are cases where material or paper get sucked onto the Air Filter on the rear panel when the projector is in use, so attention must be paid to prevent this.
- Do not place the projector in a location where it is subject to the direct air flow from air conditioners or heaters.
- When the projector is to be placed near a wall, ensure that there is at least 20cm of space between the wall and the projector.
- Do not cover the projector with table cloths or other material.

Installation example

The projector may be installed in locations that conform to the installation conditions and projection methods.

Viewing projected images from the front

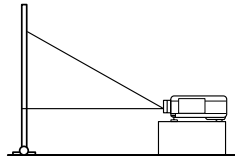
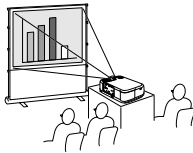

Viewing projected images from the front with a ceiling suspended projector

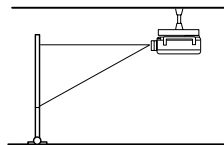
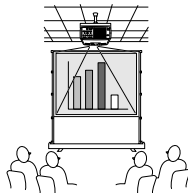

Use the optional ceiling suspension unit and set the ceiling suspension parameter to [ON]. (see [page 71](#))

Viewing images projected onto half-transparent screens from the rear.

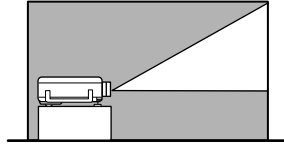
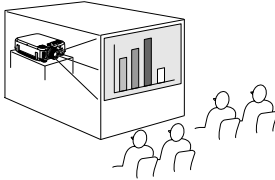

- Set the rear parameter to [ON]. (see page 71)
- Ceiling suspension is also possible with the use of the optional ceiling suspension unit.

Screen size and projection distance

Determines the distance that the screen must be from the lens in order to obtain the required screen size.

The projector's Standard Lens is approximately a 1.3x zoom lens and the largest screen size is about 1.3 times the size of the smallest screen.

Using the following table for reference purposes, install the projector so that the screen size is smaller than the screen.

Screen Size	Approximate Projection Distance	
	EMP-7600	EMP-5600
30-inch (61×46cm)	1.1m to 1.3m	1.1m to 1.4m
40-inch (81×61cm)	1.5m to 1.8m	1.5m to 1.8m
60-inch (120×90cm)	2.2m to 2.8m	2.3m to 2.8m
80-inch (160×120cm)	3.0m to 3.8m	3.0m to 3.8m
100-inch (200×150cm)	3.7m to 4.8m	3.8m to 4.8m
200-inch (410×300cm)	7.4m to 9.7m	7.6m to 9.7m
300-inch (610×460cm)	11.2m to 14.5m	11.4m to 14.6m

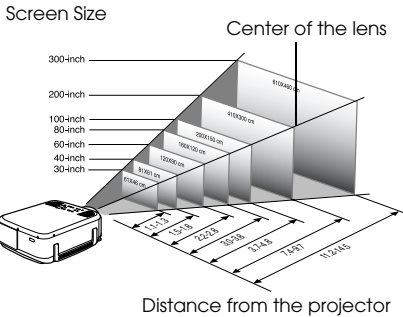

EMP-7600

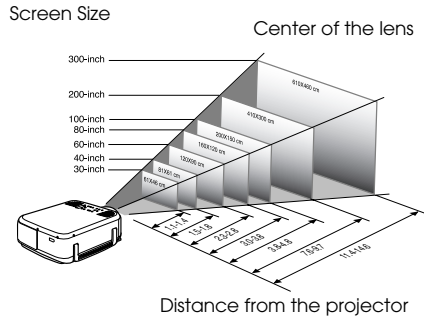

EMP-5600

Point

- The projection distances listed above are the distances when the standard lens is in use. If optional lenses are to be used, refer to the relevant instruction manuals for further details.
- The screen will become smaller when the keystone correction function is used.

Projection angles

The optimum projection screen is acquired by placing the center of the projector's lens and a right-angle to the screen.

When viewing from the side

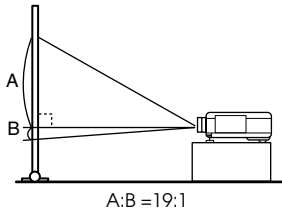

When viewing from the top or bottom

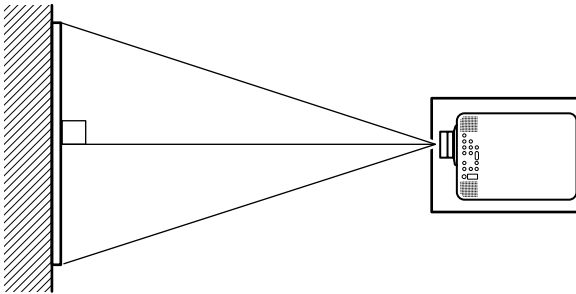

Point

Although the projection angle can be adjusted with the front foot ([see page 47](#)), there are cases where the screen will distort into a trapezoid shape. Adjust trapezoidal distortion with the keystone correction function. ([see page 49](#))

Connections

This section provides explanations on connecting the projector to computers and video equipment.

■ Connecting the projector to a computer

Switch off the power supply to the projector and computer before attempting to make the connection.

Eligible computers

There are computers with which connections cannot be established and computer that cannot be used for projection purposes even though a connection has been established. First of all, it is necessary to confirm that a connection can be established with the computer in use.

● Conditions for eligible computers

Condition #1: The computer must be fitted with an image signal output port.

Check to ascertain that the computer is fitted with ports that will output image signals, such as the [RGB Port], the [Monitor Port] and the [Video Port]. If you have trouble confirming this, refer to chapter on external monitor connections in the computer's instruction manual.

There are computers, such as combined computer/monitor models and laptop models, that do not allow connections or for which optional external output ports must be purchased.

Point

Depending on the computer, there are cases when it is necessary to switch the image signal output with the connection key (≡□, etc.) and the settings.

NEC	Panasonic	Toshiba	IBM	SONY	FUJITSU	Macintosh
Fn+F3	Fn+F3	Fn+F5	Fn+F7	Fn+F7	Fn+F10	Mirroring is set up with Control Panel - Monitor adjustments after restarting the system.

The table shown above provides examples for certain products. Refer to the computer's instruction manual for further details.

Condition #2: The resolution and frequency of the computer must be within the boundaries listed in the chart on the next page.

Projection will not be possible if the computer does not support the output image signal resolutions and frequencies shown in the chart on the next page (there are cases where projection is possible, but vivid projection will not be possible).

Confirm the image signal resolution and frequency with the computer's instruction manual.

There are also computers available that allow the output resolution to be amended. In this case, amend the parameters to fit within the ranges shown in the chart on the next page.

In the case of the EMP-7600

Signal	Refresh Rate (Hz)	Resolution (Dots)	Pixels (dots) Used During Resizing Display (Resize On)	Pixels (dots) Used During Real Display (Resize Off)	Remarks
PC98		640×400	1024×640	640×400	
VGACGA		640×400	1024×640	640×400	
VGAEGA		640×350	1024×560	640×350	
VGA	60	640×480	1024×768	640×480	
VGA Text		720×400	1024×568	720×400	
		720×350	1024×498	720×350	
VESA	72/75/85/100/120	640×480	1024×768	640×480	
SVGA	56/60/72/75/85/100/120	800×600	1024×768	800×600	
XGA	43i/60/70/75/85/100	1024×768	1024×768	1024×768	
SXGA	60/70/75/85	1152×864	1024×768	1152×864	Virtual (Partial) Display
SXGA	60/75/85	1280×960	1024×768	1280×960	Virtual (Partial) Display
SXGA	43i/60/75/85	1280×1024	960×768	1280×1024	Virtual (Partial) Display
SXGA+		1440×1080	1024×768	1440×1080	Virtual (Partial) Display
UXGA	48i/60/65/70/75/80/85	1600×1200	1024×768	1600×1200	Virtual (Partial) Display
MAC13		640×480	1024×768	640×480	
MAC16		832×624	1024×768	832×624	
MAC19		1024×768	1024×768	1024×768	
MAC21		1152×870	1016×768	1152×870	Virtual (Partial) Display
NTSC			1024×768	1024×576	4:3 ↔ 16:9, Selectable
PAL			1024×768	1024×576	4:3 ↔ 16:9, Selectable
SECAM			1024×768	1024×576	4:3 ↔ 16:9, Selectable
SDTV (480i/P)	60		1024×768	1024×576	
HDTV (720P)16:9	60		1024×576 (16:9)		
HDTV (1080i)16:9	60		1024×576 (16:9)		

In the case of EMP-5600

Signal	Refresh Rate (Hz)	Resolution (Dots)	Pixels (dots) Used During Resizing Display (Resize On)	Pixels (dots) Used During Real Display (Resize Off)	Remarks
PC98		640×400	800×500	640×400	
VGACGA		640×400	800×500	640×400	
VGAEGA		640×350	800×438	640×350	
VGA	60	640×480	800×600	640×480	
VGA Text		720×400	800×444	720×400	
		720×350	800×388	720×350	
VESA	72/75/85/100/120	640×480	800×600	640×480	
SVGA	56/60/72/75/85/100/120	800×600	800×600	800×600	
XGA	43i/60/70/75/85/100	1024×768	800×600	1024×768	
SXGA	60/70/75/85	1152×864	800×600	1152×864	Virtual (Partial) Display
SXGA	60/75/85	1280×960	800×600	1280×960	Virtual (Partial) Display
SXGA	43i/60/75/85	1280×1024	750×600	1280×1024	Virtual (Partial) Display
SXGA+		1440×1080	800×600	1440×1080	Virtual (Partial) Display
MAC13		640×480	800×600	640×480	
MAC16		832×624	800×600	832×624	
MAC19		1024×768	800×600	1024×768	
MAC21		1152×870	794×600	1152×870	Virtual (Partial) Display
NTSC			800×600	800×450	4:3 ↔ 16:9, Selectable
PAL			800×600	800×450	4:3 ↔ 16:9, Selectable
SECAM			800×600	800×450	4:3 ↔ 16:9, Selectable
SDTV (480i/P)	60		800×600	800×450	4:3 ↔ 16:9, Selectable
HDTV (720P)16:9	60		800×450 (16 : 9)		
HDTV (1080i)16:9	60		800×450 (16 : 9)		

In the case of the Computer1 port (mini D-sub 15-pin)

⚠ Caution

- Switch off the power supply to the projector and computer before attempting to make the connection. Failure to observe this may result in damage.
 - Confirm the shape of the cable connector and the shape of the port before making the connection. Applying excessive force when the direction or shape of the connector and port differ may result in defects and damage to the equipment.
- Connect the computer's monitor port to the Computer #1 mini D-Sub 15 Port on the projector with the computer cable supplied.
 - Set the switch to the analog setting (left-hand side) with the tip of a ballpoint pen or other pointed object.

● When the monitor port is the D-Sub 15 pin.

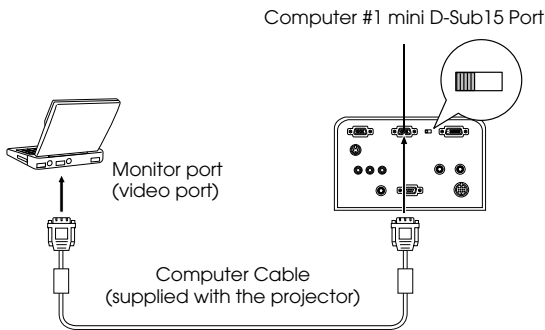

● When the monitor port is the 5BNC

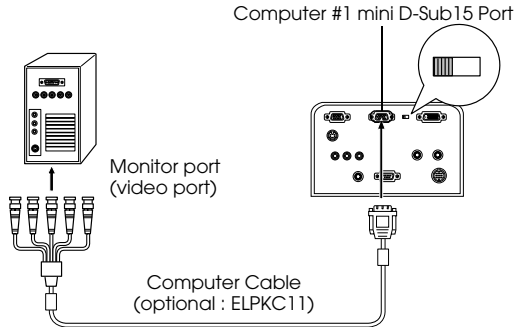

Point

- Do not bind the Power Cable and the Computer Cable together. Failure to observe this may result in video noise and malfunctions.
- An adapter may be required when making the connection depending on the stand of the computer's port. Refer to the computer instruction manual for further details.
- There are cases where the optional Mac Desktop Adapter (ELPAP01) is required when connecting up to a Macintosh.
- It is possible to establish connections with both the Computer #1 Port and the Computer #2 Port when two computers are to be connected.

● When the monitor port is 13w3

The Computer #1 Port is also connected to the D-Sub 15 port with the use of the conversion cable when the 13w3 port is used for connecting the computer's monitor port to a work station.

- The projector's computer #1 mini d-Sub 15 Port is connected to the computer's monitor port (13w3) with the 13w3 ↔D-Sub 15 cable (available on the open market).
- Set the switch to the analog setting (left-hand side) with the tip of a ballpoint pen or other pointed object.

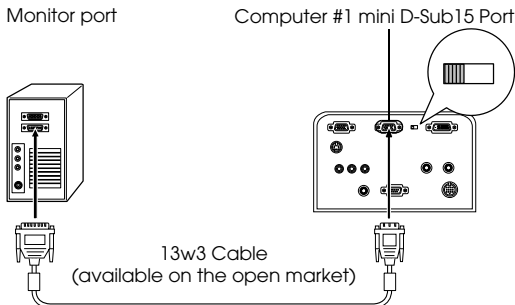

In the case of the Computer2/Component Video port

Connect the computer's monitor port to the projector's Computer #2 port with the computer cable supplied, or with an optional computer cable (ELPKC02, ELPKC09, ELPKC10).

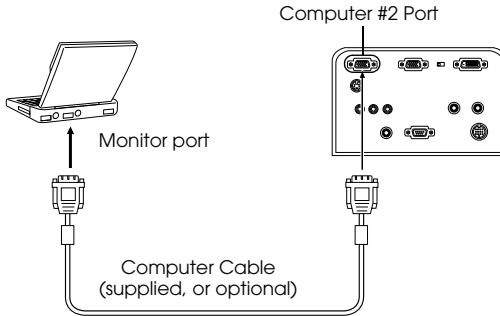

Point

- Set the Computer2 parameter in the menu to [RGB] when establishing the connection. (see page 69)
- Connections can be made to both computer #1 port and computer #2 port when two computers are to be connected.

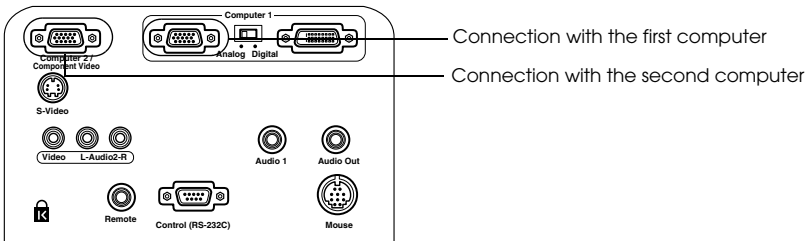

In the case of DVI-D*

Digital signals are output to the projector without amendment if a digital video card for liquid crystal displays and output port are mounted onto the computer.

- Connect the Computer's digital output port to the projector's Computer #1 DVI-D port with the optional digital video cable (ELPKC20/21).
- Set the switch to the digital setting (right-hand side) with the tip of a ballpoint pen or other pointed object.

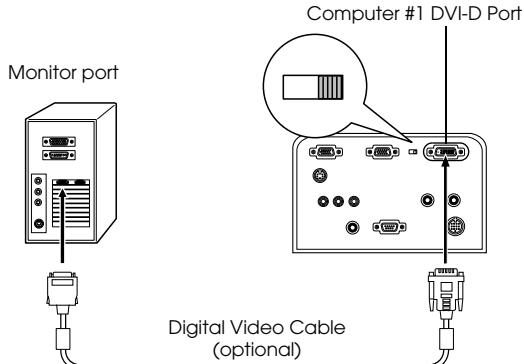

Point:

- There are cases where the computer must be set up in order to switch the computer output to the DVI-D. Refer to the instruction manual for the computer for further details.
 - If a mini D-sub 15-pin computer is to be connected at the same time, connect it to the Computer #2 port.
-

Sound connection

The projector is equipped with two built-in speakers capable of outputting a maximum of 3W, and it is also possible to output computer sound from the projector's speakers.

● Connecting the computer to Computer #1

Connect the projector's Audio1 Port (stereo mini jack) to the computer's audio output port with the Audio Cable supplied.

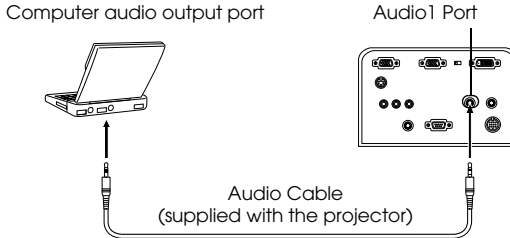

● Connecting the computer to Computer #2

Connect the computer's audio output port to the projector's L-Audio2-R port (RCA pin jack) with the RCA audio cable (sold on the open market).

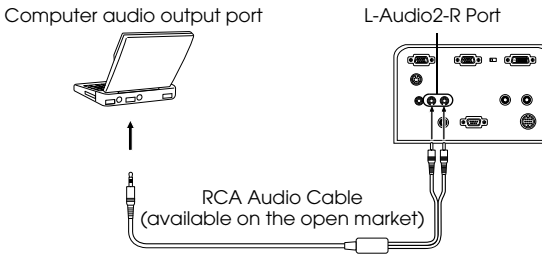

Point

The audio signals are connected with an audio cable and output the sound for the selected image.

Connecting external audio equipment

It is possible to enjoy dynamic sound by connecting the Audio Out port on the projector to a PA system, an active speaker system, or other speakers equipped with built-in amplifiers.

External audio equipment

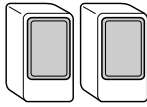

Audio Out port

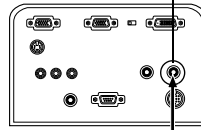

Audio connection cable (available on the open market)

Use audio connection cables available on the open market (pin plug <--> 3.5mm stereo mini-jack plug).

Point

- The sound is output externally when the stereo mini-jack is inserted into the Audio Out port. Sound will not be output from the projector's speakers when this connection is made.
 - The sound on the images being projected will be output.
 - Purchase an audio connection cable that matches up with the connector on the external audio equipment to be used.
-

Connecting the mouse (wireless mouse function)

This enables the computer's mouse pointer to be operated with the remote control in the same way as a wireless mouse.

Connect the computer's mouse port to the projector's Mouse ports with the use of a mouse cable.

Computer	Mouse to use	Mouse cable to use
PC/AT DOS/V	PS/2 mouse	PS/2 mouse cable (supplied)
	USB mouse	USB mouse cable (supplied)
Macintosh	USB mouse	USB mouse cable (supplied)

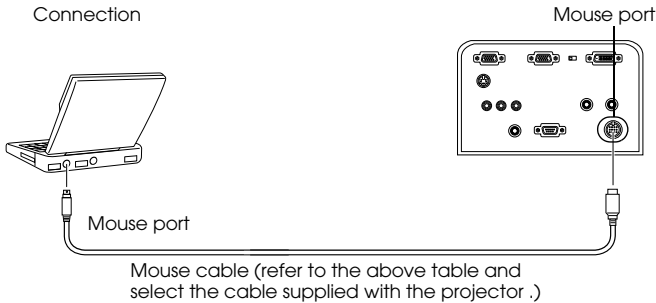

Point

- Only the USB standard mounted model supports USB Mouse Cable connections. In the case of Windows, only the Windows 98/2000 preinstalled model is supported. Operations cannot be guaranteed on upgraded Windows 98/2000 environments.
- Only a computer mouse connected to the mouse port can be used.
- There are cases where the computer must be set up to use a mouse. Refer to the instruction manual for the computer for further details..
- Switch off the power to the projector and computer before making the connection.
- It is necessary to reboot the computer if it does not work.
- Consult with your vendor if you wish to use a serial mouse, or an ADB mouse on a Macintosh.

Perform the following mouse operations after the connection has been established:

Left click ----- Press the [Enter] button.

Right click ----- Press the [Esc] button.

Mouse pointer movement ----- Lower the remote control [Enter] button.

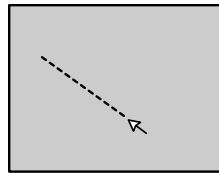
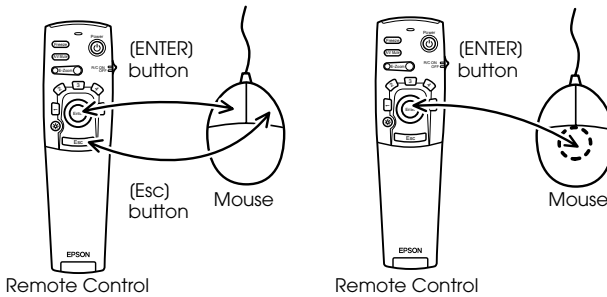

Point

- The operations will be reversed if the left/right button functions of the mouse pointer have been amended with the computer.
 - The mouse cannot be used when the menu is displayed, when the Effect, Picture-in-Picture, or E-Zoom functions are in use, or when the video image is displayed at real size.
 - The movement speed of the mouse pointer can be changed. ([see page 69](#))
-

■ Connecting the video equipment

Switch off the power supply to the projector and video equipment prior to attempting to make the connection.

In the case of composite image signals

- Connect the projector's Video Port to the video equipment with the supplied RCA Video Cable (Yellow).
- Connect the L-Audio2-R ports with the RCA audio cable supplied (red/white) to output sound from the projector's speakers.

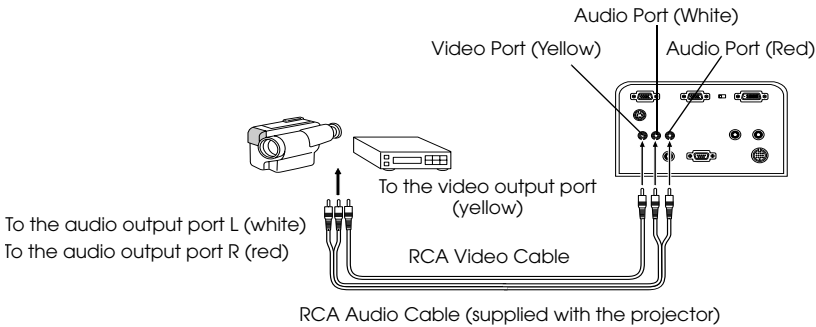

In the case of S image signals

- Connect the projector's S-Video Port to the video equipment with the S-Video cable (available on the open market).
- Connect the L-Audio2-R ports with the RCA audio cable supplied (red/white) to output sound from the projector's speakers.

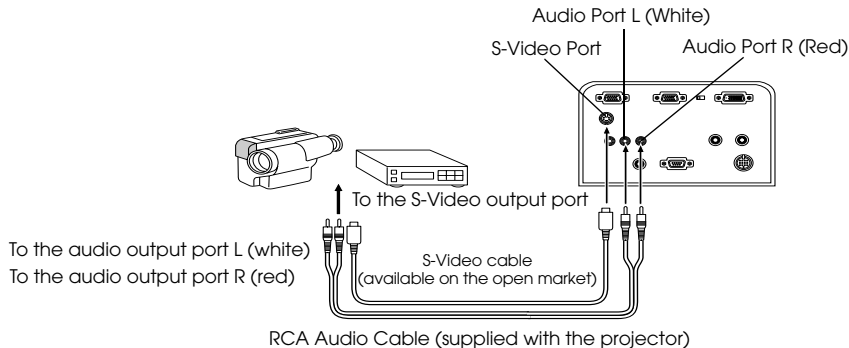

In the case of component (color differential*) image signals

- Connect the video equipment to the projector's Computer 2/Component Video port with an optional component video cable (ELPKC19).
- Connect the L-Audio2-R ports with the RCA audio cable supplied (red/white) to output sound from the projector's speakers.

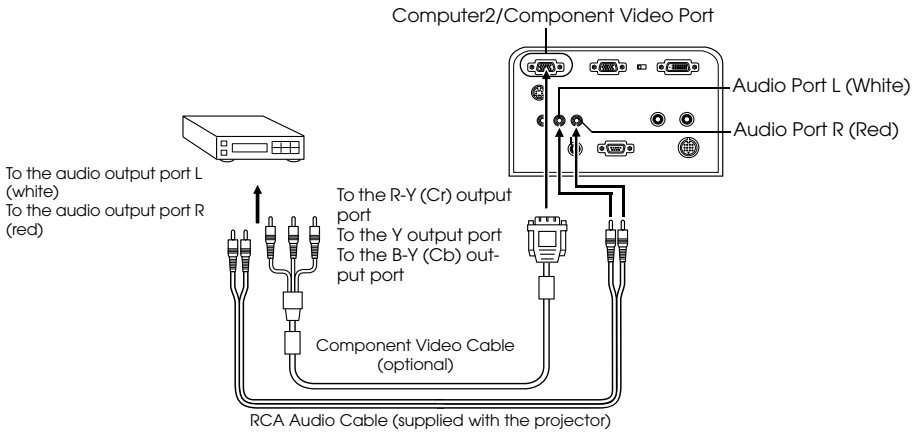

Point

Set the Computer2 parameter on the menu to [YCbCr] or [YPbPr], as appropriate for the input signal being used, when the connection has been established. ([see page 69](#))

In the case of the digital tuner's D output port

- Connect the digital tuner to the projector's Computer2/Component Video port with the optional D port cable (ELPKC22).
- Connect the L-Audio2-R ports with the RCA audio cable supplied (red/white) to output sound from the projector's speakers.

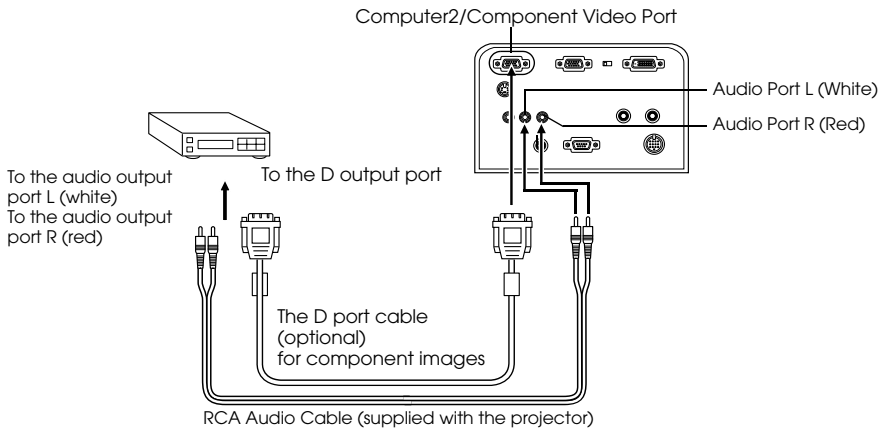

Point

- Set the Computer2 parameter on the menu to [YCbCr] or [YPbPr], as appropriate for the input signal being used, when the connection has been established. ([see page 69](#))
 - Establishing connections with digital tuners is only possible in Japan.
 - Supports digital tuners up to the D4 rating.
-

In the case of RGB image signals

- Connect the projector's Computer2/Component Video port to the video equipment with the component image cable (available on the open market).
- Connect the L-Audio2-R ports with the RCA audio cable supplied (red/white) to output sound from the projector's speakers.

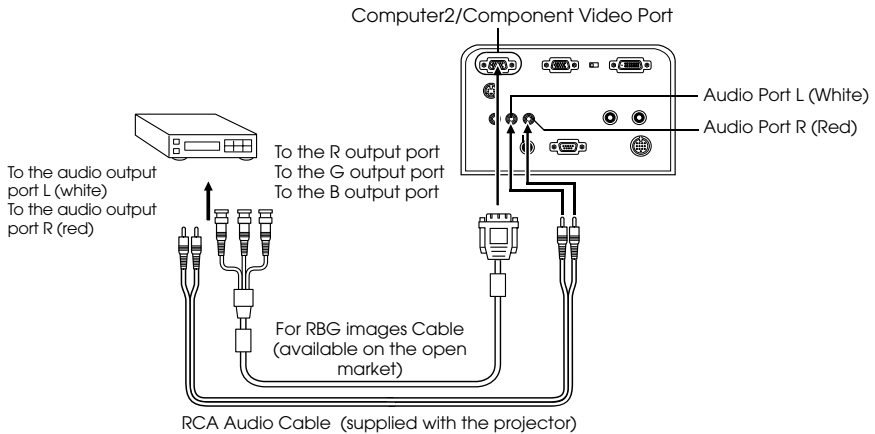

Point

- Purchase the RGB image cable to match the connectors on your equipment.
 - Set the Computer2 parameter on the menu to [RGB] when the connection has been established. ([see page 69](#))
-

Projecting

This section provides explanations on starting and ending projection, and on the basic functions for adjusting projected images.

■ Projection

Images can be projected after all connections have been completed.

Preparations

⚠ Warning

- Never look directly into the lens once the power supply has been switched on. Failure to observe this may result in the powerful light damaging eyesight.
- Ensure that the Power Cord supplied is used. The use of cables other than the one supplied may result in the outbreak of fire or electric shocks.

⚠ Caution

Do not perform any projection tasks with the Lens Cover attached. Failure to observe this may result in the cover becoming malformed due to heat.

1 Connect the projector to a computer and video equipment. (see page 26, 37)

2 Remove the Lens Cover.

3 Attach the supplied Power Cord to the projector.

Check to confirm the shape of the projector's Power Inlet and Power Connector, align the connector in the correct direction, and then insert it as far as it will go.

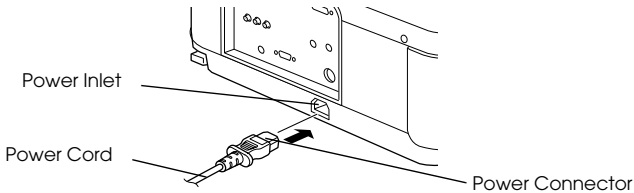

4 Plug the Power Plug into the power socket.

The Operation Indicator will be illuminated in orange.

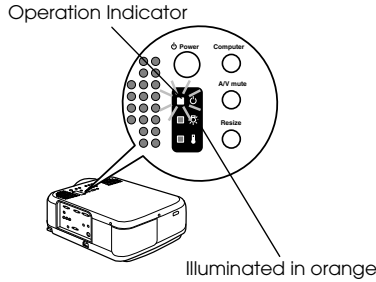

Commencing projection

1 Press the [Power] button to turn on the power supply.

The Operation Indicator will begin to blink in green, and projection will be started.

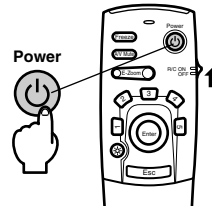
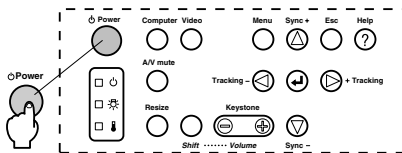

Set the R/C ON OFF switch to (ON) first of all when using the remote control unit

The Operation Indicator will change from blinking to being steadily illuminated in green after a while.



A message stating (No image signals input) will be displayed when no image signals have been input. (Depending on the no-signal setting, this message may not be displayed.) (see page 69)

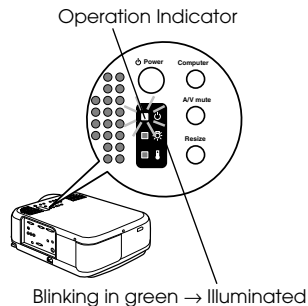

Point

Button operations are not possible when the Operation Indicator is blinking in green.

2 Select the Port to which the connection has been made when more than one item of equipment has been connected.

Press the port button connected to the computer or video equipment to switch the input source.

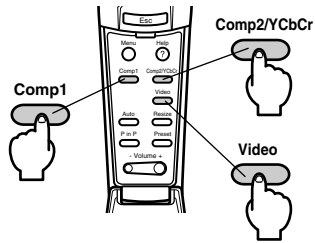
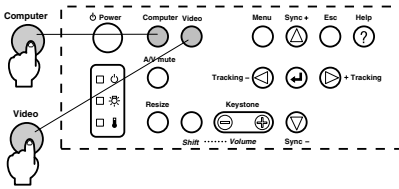

Connected Port	Button to Select		Display at the top right-hand corner of the screen
	Main Unit	Remote Control	
Computer #1 Port	[Computer] (will change whenever pressed)	[Comp1]	Computer1
Computer2/ Component Video (RGB)			Computer2 (RGB)
Computer2/ Component Video (YCbCr)	[Video] (will change whenever pressed)	[Comp2/ YCbCr]	Computer2 (YCbCr)
Computer2/ Component Video (YPbPr)			Computer2 (YPbPr)
Video Port			Video
S-Video Port		[Video] (will change whenever pressed)	S-Video

Point

- Even if there is a physical connection, the system will automatically switch to the state used immediately before power-off if there is no input signal, or if the connected equipment is not outputting a signal.
- The Computer #2/Component Video port sources that are switched with the [Computer] and [Video] keys on the projector and the [Comp2/YCbCr] key on the remote control will only display either the Computer2 (RGB) Computer2 (YCbCr) or the Computer2 (YCbCr) depending on the Computer2 setting. ([see page 69](#))

3 Starting projection.

Switch on the power supply to the computer or video equipment. If the equipment connected is video equipment, then also press the [Playback] or [Play] buttons.

The [No Signal] display will be erased, and projection will commence.

Point

- If [No Signal] remains displayed, check the connections once again.
- Depending on the computer, there are cases when it is necessary to switch the image signal output destination with the key (B/C, etc.) or the settings after establishing the connection.

NEC	Panasonic	Toshiba	IBM	SONY	FUJITSU	Macintosh
Fn+F3	Fn+F3	Fn+F5	Fn+F7	Fn+F7	Fn+F10	Mirroring is set up with Control Panel - Monitor adjustments after restarting the system.

The table shown above provides examples for certain products. Refer to the computer's instruction manual for further details.

- Press the [Resize] button when signals that support DVD players or wide television screens (16:9 images) have been input. The parameters will change between 4:3 images and 16:9 images whenever the switch is pressed.
 - There are cases where a projected image will remain projected if a still image is projected for a long period of time.
-

Ending

End through the following procedure.

1 Turn off the connected equipment.

2 Press the [Power] button.

A message to confirm that the power needs to be switched off will be displayed.

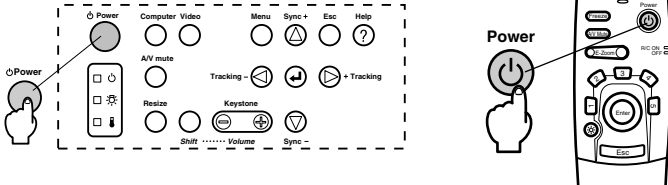

3 Press the [Power] button once more.

The lamp will be extinguished, the Operation Indicator will blink in orange, and the cool-down process will commence.

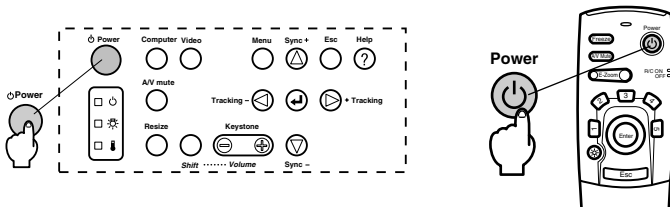
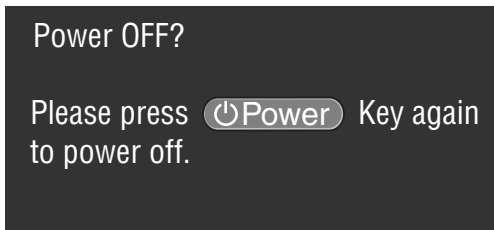

The Operation Indicator will change from blinking to being illuminated in orange once the cool-down process has been completed. The amount of time required for the cool-down is approximately 60 seconds (may be longer depending on the ambient temperature).

Point

- Press a different button if the power is not to be switched off. The message will be erased after seven seconds if no buttons are pressed (the power will remain on).
- It is also possible to end projection by pressing the [Power] button as explained in procedure #2 for more than one second (will assume the same status as if ending with procedure #3).
- Button operations are not possible when the Operation Indicator is blinking in orange. In this event, please wait until full illumination has been attained.

- 4** After cooling (check that the operation indicator is illuminated in orange), unplug the Power Plug from the socket.

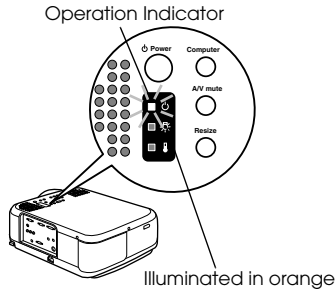

Caution

Do not remove the Power Plug from the socket when the Operation Indicator is blinking in orange. Failure to observe this may result in damage to the equipment and will speed up the period for replacing the lamp.

- 5** Set the R/C ON OFF switch to [OFF] when using the remote control.

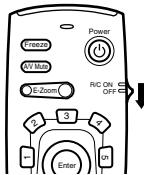

Point

The batteries are being consumed when the [R/C ON OFF] switch on the remote control unit is set at [ON]. Ensure that the [R/C ON OFF] switch on the remote control unit is set to [OFF] when not in use.

- 6** Restore the Front Foot if it has been extended.

Steady the projector by hand, and then lift the Foot Adjust Lever with a finger and gently lower it into the main Unit.

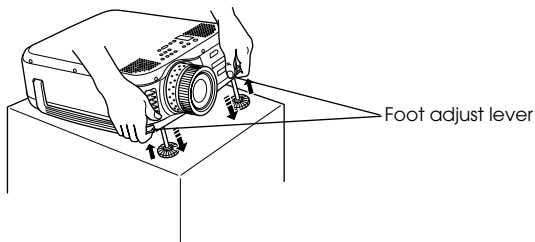

- 7** Attach the lens cover.

■ Adjusting the Projection Position

The projector can be adjusted into the following vertical projection positions.

Feet adjustments

Adjust the projection angle of the projector.

- 1** Lift the Foot Adjust Lever with a finger and raise the front part of the projector.
The Front Foot will protrude.

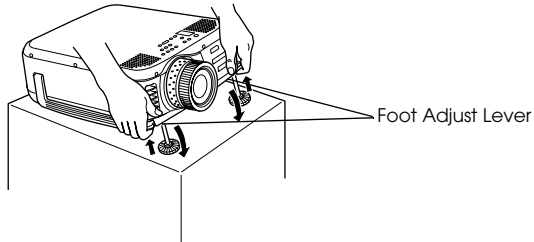

- 2** Remove your finger from the Foot Adjust Lever, and then let go of the projector.
- 3** Rotate the lower part of the Front Foot to minutely adjust the height.

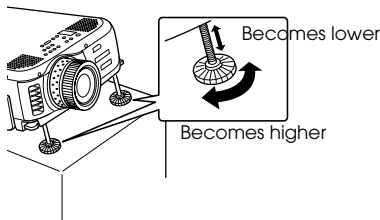

Point

- There are cases where the screen will be distorted into a trapezoid shape when foot adjustments are performed. Adjust the trapezoid distortion with the keystone correction function ([see page 49](#))
 - The Front Foot is restored by lifting the Foot Adjust Lever with a finger and lowering the projector.
-

■ Adjusting the Projection Size

It is possible to adjust the size of the projection and correct any trapezoid distortion.

Point

A function to resize the screen ([see page 56](#)) and an E-Zoom function for enlarging certain areas ([see page 57](#)) are also available.

Zoom adjustment

- 1 Rotate the Zoom Ring to make the required adjustments (enlargement up to a maximum of 1.3x is possible).

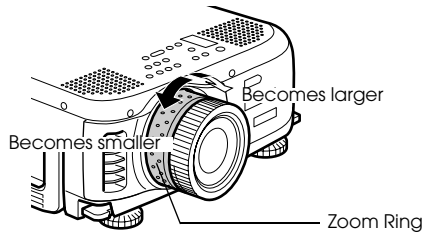

The projection distance must also be adjusted when enlarging the screen. ([see page 24](#))

Keystone adjustment

Make the necessary adjustment when the screen has been distorted into a trapezoid with foot adjustment.

1 Press the [Keystone +, -] button to lengthen the screen sideways.

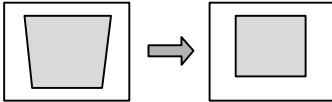
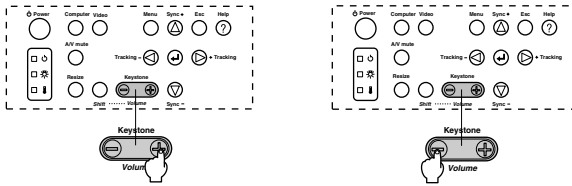

The corrected screen will shrink in size.

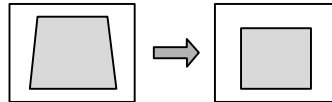

The corrected screen will shrink in size.

It is possible to use the trapezoid correction function (through 64 stages) as long as the tilt angle of the projector is within a maximum vertical range of between 30 degrees to 20 degrees.

Maximum of between 30 degree and 20 degrees upward

Maximum of between 30 degree and 20 degrees downward

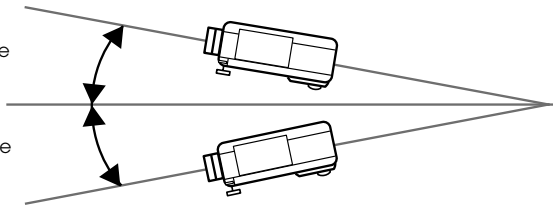

The maximum value for the tilt angle differs as shown below in accordance with the size of the projected image adjusted with zoom.



Point

- The screen will be reduced in size when keystone correction has been performed.
- The status of the keystone correction will be recorded. Perform readjustments that match the installation position when the projector position or angle have been changed.
- Reduce the sharpness if blurring occurs after keystone correction. ([see page 67](#))
- Keystone correction is performed from the menu ([see page 69](#))

Picture Quality Adjustment

Adjusts image focus and disturbance.

Focus adjustment

Aligns the focus of the image.

- 1 Rotate the Focus Ring to make the required adjustment.

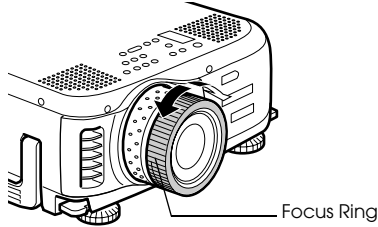

Point

- It is not possible to align the focus if the lens is dirty or fogged over with condensation. In this event, clean the lens accordingly. (see page 85)
- Fine adjustments will not be possible if the installation distance is outside of the 1.1 to 14.5m range (EMP-7600) or the 1.1 to 14.6m range (EMP-5600). Check the installation distance. (see page 24)

Auto adjustment (when projecting computer images)

Automatically adjusts the computer image to attain the optimum effect. The items adjusted include the Tracking, Position and Sync.

- 1 Press the [↵Enter] button on the projector (the [Auto] button on the remote control).

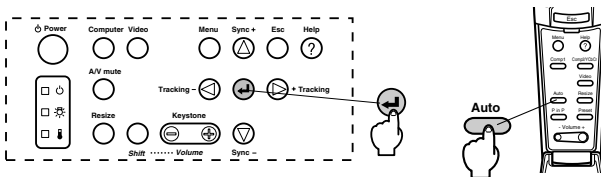

Point

- If auto adjustments are initiated when the E-Zoom, A/V Mute or Picture-in-Picture functions are executing, adjustment will not be carried out until the executing function has been cancelled.
- Depending on the type of signals being output by the computer, there are cases when adjustment cannot be carried out correctly. In this event, adjust the Tracking and Sync. (see page 51)

Tracking adjustments (when projecting computer images)

Adjusted when vertical stripes are apparent on the computer image.

1 Press the [Tracking +, -] button on the projector.

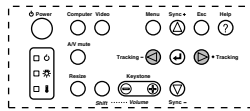
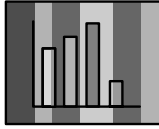

Synchronization adjustments (when projecting computer images)

Adjusted when flashing, blurring and vertical noise are apparent on the computer image.

1 Press the [Sync +, -] button on the projector.

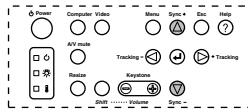
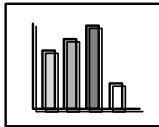

Calling out adjustment values (when projecting computer images)

It is possible to record preset adjustment values and call them out when required.

1 Press the [Preset] button on the remote control.

The pre-registered numbers between preset #1 and preset #5 will change in sequence whenever this button is pressed.

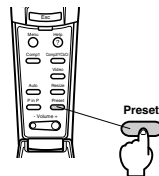
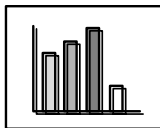

Point

- There are cases when these adjustments must be made again if the values output from the computer (resolution, display color) are amended after flashing and blurring have been adjusted.
- There are cases where flashing and blurring is caused by adjusting the brightness and contrast*.
- Images will be projected more vividly if synchronization adjustments are made after the tracking adjustments.
- Auto adjustments, tracking adjustments and synchronization adjustments are not possible if no image signals are being input by the computer, such as when projecting video images.
- The preset values must be registered beforehand. (see page 67)

■ Introduction of Functions

The functions that can be operated by pressing buttons when images are being projected are listed below.

Function	Outline	Button		Reference Page
		Main Unit	Remote Control Unit	
Help	Displays the method of solving problems when trouble occurs.	Help	Help	53
A/V Mute	Temporarily mutes the image and sound.	A/V mute	A/V Mute	55
Freeze	Freezes the image.	-	Freeze	55
Resize	Changes the size of the image.	Resize	Resize	56
E-Zoom	Enlarges the image.	-	E-Zoom	57
Effect	Adds decorations to the image.	-	[1]-[5](Effect)	58
P in P	Adds a sub-screen to the image.	-	P in P	61
Preset	Calls out pre-registered adjustment values.	-	Preset	51
keystone correction	Adjusts trapezoid distortion.	Keystone	-	49
Auto adjustment	Automatically adjusts the image for optimum effect.	↵(Enter)	Auto	50
Tracking	Adjusts vertical stripes that appear on the image.	Tracking	-	51
Synchronization	Adjusts flashing, blurring and vertical noise that appears on the image.	Sync	-	51
Volume	Adjusts the volume.	Shift + Volume	Volume	62
Menu	Displays the menu.	Menu	Menu	65

Useful Functions

This section provides explanations on the effective and useful functions, such as presentations, available with this projector.

Useful Functions

Help Function

The methods of solving trouble when it occurs are divided into separate sections and explained below for use when problems arise.

1 Press the [Help] button.

The help menu will be displayed.

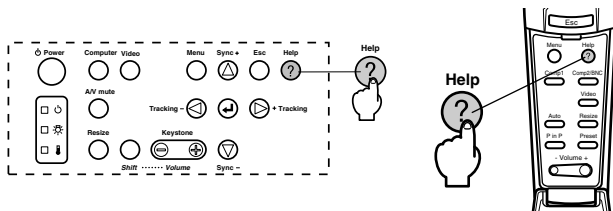

2 Select the item.

Press the [Sync+, -] button on the main unit (move the [Enter] button up and down on the remote control) to select the item.

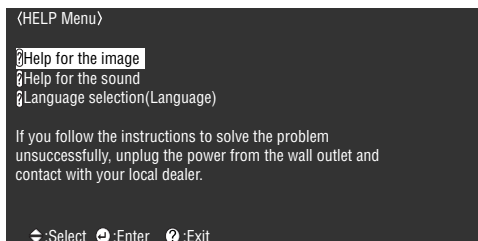

3 Set the item.

Set the item by pressing the [Enter] button on the main unit (the [Enter] button on the remote control unit).

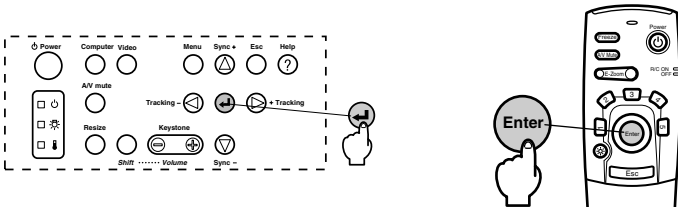

4 Repeat the operations explained in procedures 2 and 3 to select and set the detailed items.

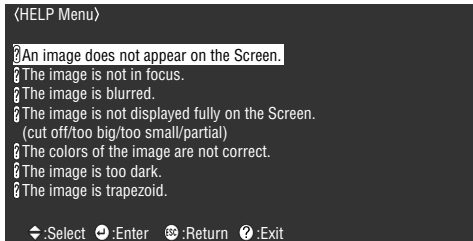

Point

- Refer to [Troubleshooting] in this manual if the help text does not solve your problems. (see page 74)
- The help menu can be canceled by pressing the [Help] button.

■ Projection Cutting

It is possible to temporarily erase and halt images and sound.

A/V Mute Function

Temporarily erases images and sound.

1 Press the [A/V Mute] button.

The images and sound will be erased.

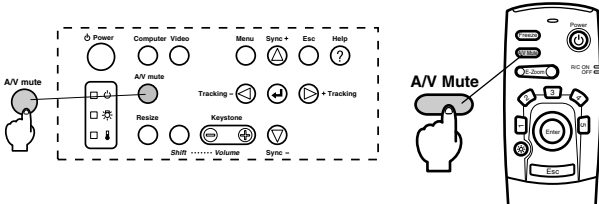

Projection will restart when the [A/V Mute] button is pressed again, when the volume is adjusted, or when the menu is displayed.

Depending on the setting, three different types of statuses may be selected when temporarily erasing images and sound. (see page 69)

Black color



(Default setting)

Blue color



User logo



Point

The Epson logo has been registered in the user logo. User logo registration and setup is necessary to amend the user logo. (see page 70)

Freeze Function

Temporarily freezes the image; however, the sound is not muted.

1 Press the [Freeze] button.

The image will freeze.

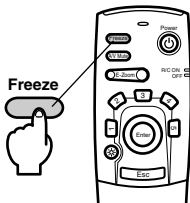

Press the [Freeze] button once more to cancel this mode.

Switching Image Sizes

The window display and resizing display are switched when projecting images onto a computer. Video image projections are switched between an aspect ratio of 4:3 and 16:9.

1 Press the [Resize] button.

The screen size will switch.

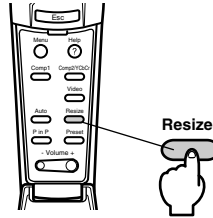
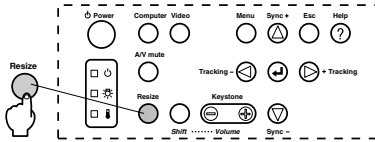

In the case of computer images

Windows display : Projected at the entered resolution (real size display). There are cases where the projection size and the image size are different.

Resizing display : Projected with the resolution reduced or expanded so that the image fits the entire size of the projection.

Example: When the input resolution is smaller than the display resolution. (in the case of 640 x 480)

Resizing display

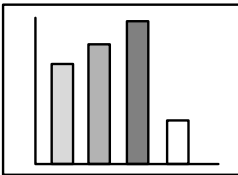

Window display

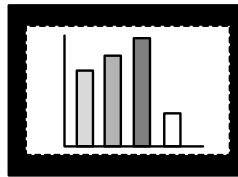

Example: When the input resolution is greater than the display resolution. (EMP-7600: In the case of 1600 x 1200, EMP-5600: In the case of 1280 x 1024)

Resizing display

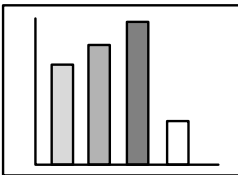

Window display

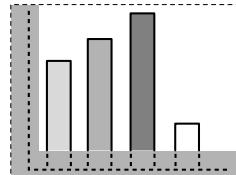

Point

- The size will not be switched if the display resolution of the liquid crystal is the same as the entered resolution (EMP-7600 : 1024 x 768 dots, EMP-5600 : 800 x 600 dots).
- A certain portion of the image will not be displayed if the entered resolution is larger than the display resolution of the liquid crystal. Lower the [Enter] button on the remote control unit to scroll through the areas not displayed.
- Certain areas on the left and right will not be displayed when SXGA (1280 x 1024 dots) is being displayed. Press the [Resize] button while pressing the [Shift] key on the main unit to cycle between left size, right side, full-screen enlargement and centered.

● In the case of video images

Switching will be performed for 4:3 and 16:9 image sizes. Images recorded with digital videos and DVD images can be projected on 16:9 wide screens.

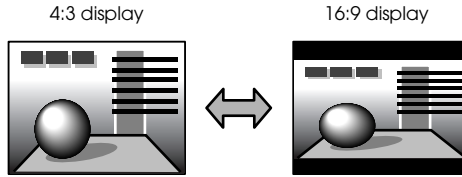

■ Enlarging Images (E-Zoom function)

It is possible to enlarge selected portions of projected sizes without amendment.

1 Press the [E-Zoom] button.

The size percentage will be displayed in the bottom right-hand corner to enable the image to be reduced or enlarged.

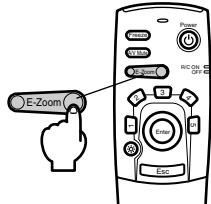
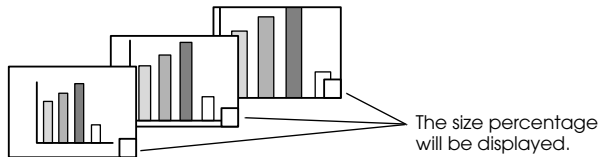

Point

- Enlargement is possible with 24 stages between 1x and 4x at increments of 0.125x.
 - A certain portion of the image will not be displayed when it has been enlarged. Lower the [Enter] button on the remote control to scroll the screen and display this portion accordingly.
 - Sub-screens will be enlarged when the Picture-in-Picture function is being used.
-

■ Effect Function

The [Effect] buttons add decorations to images displayed during presentations. The decoration settings can be amended on the effect menu. ([see page 68](#))

Cursor/Stamp

Imprints a stamp on the image.

1 Press the [1] button on the remote control unit.

The selection will switch between three different cursor/stamps whenever the [1] button is pressed.

2 Lower the [Enter] button on the remote control unit to move the position of the cursor/stamp.

3 The stamp will be imprinted at the location of the cursor when the [Enter] button on the remote control unit has been pressed.

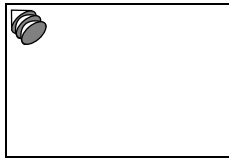

Point

- The effect function will be canceled and the cursor will disappear when the [Esc] button is pressed.
 - The decoration will be erased when the [5] button is pressed.
 - The mouse cannot be used when the effect function is in progress.
-

Box

Draws a Box on the image.

1 Press the [2] button on the remote control unit.

2 Lower the [Enter] button on the remote control unit to move the cursor to the starting position.

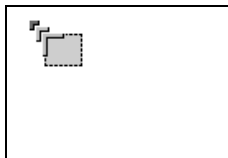

3 Press the [Enter] button to set the start position.

- 4** Lower the [Enter] button on the remote control unit to move the cursor to the ending position.

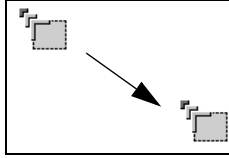

- 5** Press the [Enter] button to set the end position.

Point

- The decoration will be erased when the [5] button is pressed.
- There are cases where the effect will be difficult to see depending on the color combination of the image's background and box. Amend the color of the box in this event. ([see page 68](#))
- The mouse cannot be used when the effect function is in progress.

Spotlight

Shines a spotlight on a certain part of the image.

- 1** Press the [3] button on the remote control unit.

Will switch between three different spotlight sizes whenever the [3] button is pressed.

- 2** Lower the [Enter] button to move the spotlight.

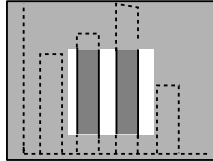

Point

- The effect function will be canceled and the spotlight will disappear when the [Esc] button is pressed.
- The mouse cannot be used when the effect function is in progress.

Bar

Draws a bar line on the image.

1 Press the [4] button on the remote control unit to display the required cursor/stamp.

The selection will switch between three different bars whenever the [4] button is pressed.

2 Press the [Enter] button to set the end position.

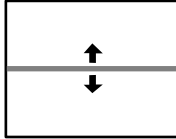

Point

- The effect function will be canceled and the bar will disappear when the [Esc] button is pressed.
 - There are cases where the effect will be difficult to see depending on the color combination of the image's background and the bar. Amend the color of the bar in this event. ([see page 69](#))
 - The mouse cannot be used when the effect function is in progress.
-

Canceling effects

1 Press the [5] button on the remote control unit.

The box, bars and other effects will disappear.

■ P in P Function

The video image (YCbCr or YPbPr) will be displayed as a sub-screen inside the computer image or component video image.

1 Press the [P in P] button.

Operation instructions will be displayed at the bottom left-hand side, and the sub-screen will be situated at the top right-hand side of the main screen.

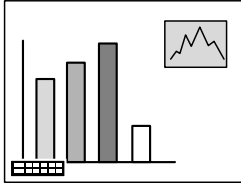

2 Press the [Enter] button on the remote control to move the position of the sub-screen.

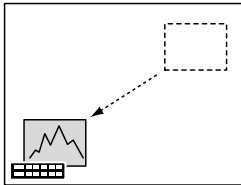

3 Press the [E-Zoom] button to change the size of the sub-screen.

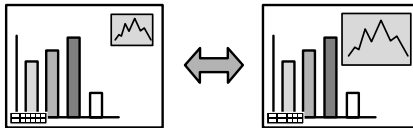

4 Press the [2] button on the remote control unit to switch to sub-screen sound.

Press the [1] button on the remote control unit to return to the main-screen sound after the sound has been switched.

5 Press the [Enter] button to set the sub-screen display.

The operation guide in the bottom left-hand corner will be erased.

Point

- The sub-screen will be erased when the [PinP] button is pressed again.
- The computer image or video image (component signal only) will be displayed in the main screen and the video image (Video, S-Video) will be displayed in the sub-screen, and the video image on the sub-screen can be amended with the PinP settings. ([see page 69](#))
- Switch the position, size, and sound of the sub-screen prior to fixing the sub-screen's display.
- The sub-screen can be switched between five different sizes.
- If the position of the sub-screen is changed, the next time PinP is used the sub-screen will be displayed at the sub-screen position set previously.
- The sound cannot be switched between screens when the main screen images are Computer2 or Component Video images, as the audio input port is shared for both the main screen and the sub-screen (Video or S-Video).

Menu Configuration

The menu enables the various adjustments and settings to be made.

Menu items

The menus are split into top menus and sub menus and consist of a hierarchy structure. Also, the image menu will differ in accordance with the input source (connected port).

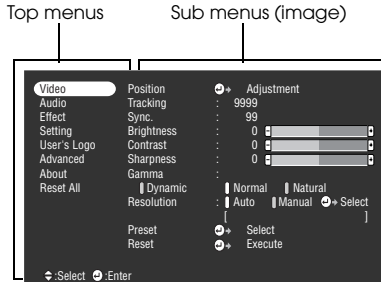

● Menu items

Image menu · Computer (D-Sub 15)



Image menu - Computer (DVI-D)

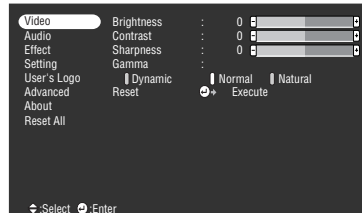

Image menu · Video (Video/S-Video)

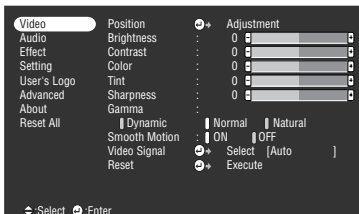

Image menu · Video (YCbCr/YPbPr)



Point

- The items displayed on the image menu will differ in accordance with the projected input source, and most menus other than that belonging to the projected input source cannot be adjusted.
- Most image menu items cannot be adjusted when no image signals are being input.

Sound menu

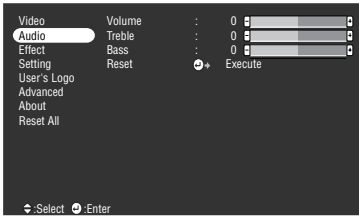

Effect menu

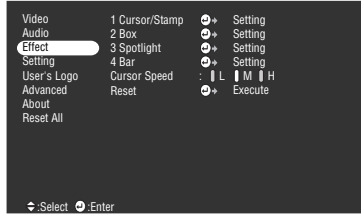

Setup menu

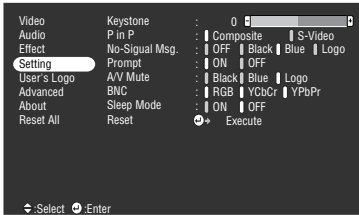

User's Logo menu

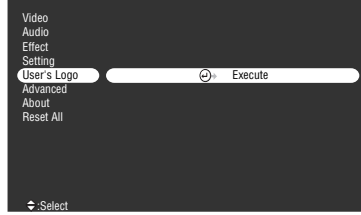

Advance settings menu



Information menu

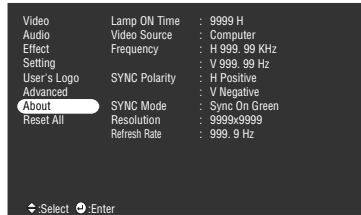

The information menu displays the setup status of the projected input source

All reset menu

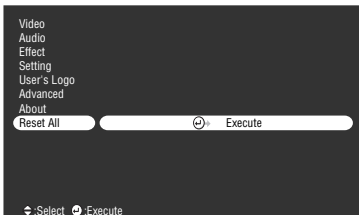

Point

The lamp illumination time is displayed as 0H between 0 and 10 hours, and in units of 1 hour above 10 hours.

Menu Operations

The menus can be operated from both the projector and the remote control unit.

Operation method

1 Press the [Menu] button.

The top menu will be displayed.

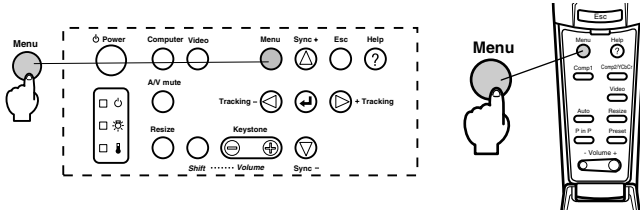

2 Select the required item.

Press the [Sync +, -] button on the projector (lower the [Enter] button up or down on the remote control unit) to select the required item.

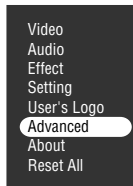

3 Set the selected item.

Press the [↵(Enter)] button on the projector (the [Enter] button on the remote control unit) to set the selected item. The sub-menu will be selected.

4 Then select the detailed sub item.

Press the [Sync +, -] button on the projector (lower the [Enter] button up or down on the remote control unit) to select the sub item.

The items displayed on the image menu and information menu will differ in accordance with the projected input source.

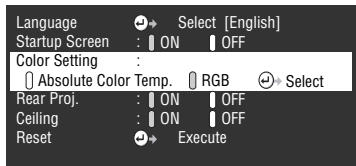

5 Select the parameter value.

Press the [Tracking +, -] button on the projector (lower the [Enter] button left or right on the remote control unit) to select the parameter value.

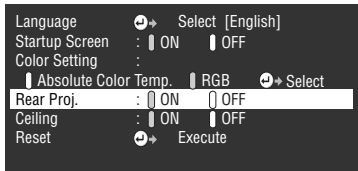

Point

- **↵** (Enter) is attached to the rear of the sub item names that execute the parameters and continue onto the lower hierarchies. Press the [Enter] button to set this selection, and then select the parameter setting again.
- Refer to the list of settings for further information on the function of each setting. ([see page 67](#))

6 Set all of the other items in the same way.

7 Press the [Menu] button.

The menu will end.

Point

- Press the [Esc] button to return to the previous menu in the hierarchy.
 - The items displayed on the image menu will differ in accordance with the projected input source, and menus other than that belonging to the projected input source cannot be adjusted.
 - Image menus cannot be adjusted when no image signals are being input.
-

Setting items

Top Menu	Sub Menu	Function	Default Value
Video	Position	Moves the image's display position up, down, left and right. Press the [Enter] button to make the required adjustments on the position adjustment screen displayed.	Depends on the connection signals
	Tracking	Adjusts vertical stripes that appear on the Computer image.	Depends on the connection signals
	Sync.	Adjusts disturbance, blurring and vertical noise that appears on the Computer image. · Disturbance and blurring may occur as a result of adjusting the brightness and contrast. · It is possible to regulate the vividness of the image by adjusting the synchronization after adjusting the tracking.	30
	Brightness	Adjusts the brightness of the image.	Center value (0)
	Contrast	Adjusts the contrast of the image.	Center value (0)
	Color	Adjusts the color depth of the image.	Center value (0)
	Tint	Adjusts the tint of the image.	Center value (0)
	Sharpness	Adjusts the sharpness of the image.	Center value (0)
	Gamma	Corrects the color vividness of the image. Dynamic: Produces an image with clear color differences. Suitable for displaying plans, etc. Normal: Projects tint without correction. Natural: Produces an image with natural tint. Suitable for video images.	Normal
	Resolution	Sets the input resolution. Auto: Automatically adjusts the input resolution. Manual: Press the [Enter] button and select the required setting from the input resolution selection menu displayed.	Auto
Preset	It is possible to save the current computer input signal adjustment values (input resolution, tracking, synchronization signals, Brightness, Contrast, Sharpness, Gamma display position). Press the [Enter] button and select the preset number under which registration is to be performed from the preset selection menu displayed. · The adjustment values registered under a preset number represent the current status of the system. Ensure that the optimum values have been set up before registering this data. · The preset adjustment values can be called out by pressing the [Preset] button. (see page 51)	Not registered	

Top Menu	Sub Menu	Function	Default Value
Video	Video Signal	Sets the video signal method. Press the [Enter] button and select the required setting from the video signal method selection menu displayed. · The video signal method will be automatically set up in the [Auto] mode, but do not use the [Auto] mode for the PAL system (60Hz).	Auto
	Reset	Returns all image menu adjustment values to the default values. Press the [Enter] button and then select [Yes] on the confirmation screen displayed. · Select [Reset All] to return all image and sound values to the default settings. (see page 71)	-
Sound	Volume	Adjusts the volume.	15
	Treble	Adjusts the strength of the high tones.	Center value (0)
	Bass	Adjusts the strength of the low tones.	Center value (0)
	Reset	Returns all sound menu adjustment values to the default values. Press the [Enter] button and then select [Yes] on the confirmation screen displayed. · Select [Reset All] to return all image and sound values to the default settings. (see page 71)	-
Effect	Cursor/Stamp	Sets the shape, size, color and length of the cursor/stamps allocated to the [1] button on the remote control unit. Press the [Enter] button and select the item to be displayed from the cursor/stamp setup menu. The shape, size, color and length conditions can be set by pressing button types 1 to 3. Depending on the selected cursor shape, size, color and length cannot be set up. · The [1] button executes the cursor/stamp function. The cursor/stamp types will be switched between 1 and 3 sequentially for each time the [1] button is pressed. (see page 58)	Individual settings between types 1 to 3
	Box	Sets the use/non-use and shape of the color and shading of the Box allocated to the [2] button on the remote control unit. Press the [Enter] button and select the required item from the Box setup menu. · The [2] button executes the Box function. (see page 58)	Color: Magenta Shading: No Shape: Square
	Spotlight	Sets the size of the spotlight allocated to the [3] button on the remote control unit. Press the [Enter] button and select the required item from the spotlight setup menu. · The [3] button executes the spotlight function. (see page 59)	Size: Medium

Top Menu	Sub Menu	Function	Default Value
Effect	Bar	Sets the color, direction and width of the bar allocated to the [4] button on the remote control unit. Press the [Enter] button and select the required item from the bar setup menu. The color, direction and width can be selected independently for each of the settings between 1 and 3. · The [4] button executes the bar function. The bar types will be switched between 1 and 3 sequentially for each time the [4] button is pressed. (see page 60)	Individual settings between types 1 to 3
	Cursor Speed	Selects the speed of Cursor. L: Slow M:Medium H:Fast	M
	Reset	Returns all effect menu adjustment values to the default values. Press the [Enter] button and then select [Yes] on the confirmation screen displayed. · Select [Reset All] to return all image and sound values to the default settings. (see page 71)	-
Setting	Keystone	Adjusts images which appear trapezoidal. · The screen will be reduced in size when keystone correction has been performed. · The status of the keystone correction will be recorded. Perform readjustments that match the installation position when the projector position or angle have been changed. · Reduce the sharpness if blurring occurs after keystone correction. (see page 67)	Center value (0)
	P in P	Sets the input source for the P in P function's sub-screen. · The P in P function is executed by pressing the [PinP] button on the remote control unit. (see page 61)	Composite
	No Signal Msg	The status for [No Image Signal Input] and other message display. · The user logo must be registered and set up before it can be amended.	Blue
	Prompt	Sets whether to display the input source on the screen or not.	ON
	A/V Mute	Sets up the screen status for when the [A/V Mute] button is pressed. · User logos must be registered and set up before they can be amended.	Black
	Computer2	Sets the mode for the input image signals connected to the Computer2/Component Video port. RGB : Set when the input is a RGB signal. YCbCr : Set when the input is a component video signal (YCbCr). YPbCr : Set when the input is a component video signal (YPbCr).	RGB

Top Menu	Sub Menu	Function	Default Value
Setting	Sleep Mode	Sets the energy-saving function for when no image signals are being input. When this is set at [ON], projection will be automatically ended and the projector will enter the sleep mode if no image signals are input and no operations are performed for a period of thirty minutes (the operation indicator will be illuminated in orange). Press the [Power] button to restart projection.	ON
	Reset	Returns all setting menu adjustment values to the default values. Press the [Enter] button and then select [Yes] on the confirmation screen displayed. · Select [Reset All] to return all image and sound values to the default settings. (see page 71)	-
User's Logo	Execute	Registers user logos. (see page 72) Press the [Enter] button and follow the instructions displayed on the confirmation screen. · The saving procedure requires a certain amount of time to complete. Do not attempt to operate the projector or the equipment connected to the projector while this procedure is running. Failure to observe this may result in damage. · The size that can be registered is 400 x 300 dots. · The display size will be adjusted when video images are being projected.	EPSON'S logos
Advanced	Language	Sets the language with which messages are to be displayed. Press the [Enter] button and select the required language from the language selection menu displayed.	English
	Startup Screen	Displays the user logo during warm-up after the power has been switched on. · The user logo must be registered and set up before it can be amended.	ON
	Color Setting	Adjusts the color temperature of the image. Absolute color temperature: Sets the color temperature. RGB: Sets the strength of the RGB colors (red, green and blue.) Press the [Enter] key to display the color setup menu, select the R, G and B items, and then set the required value. · Set the color temperature value to the yardstick value.	Absolute color temperature 7500K

Top Menu	Sub Menu	Function	Default Value
Advanced	Rear Proj.	Set at [ON] to project images onto a half-transparent screen from the rear. The projected image will be inverted.	OFF
	Ceiling	Set at [ON] to project images when suspended from the ceiling. The projected image can be inverted from left to right and up and down. · The optional ceiling suspension unit is required to suspend the projector from the ceiling. (see page 90)	OFF
	Reset	Returns all advanced setting menu adjustment values to the default values. Press the [Enter] button and then select [Yes] on the confirmation screen displayed. · Select [Reset All] to return all image and sound values to the default settings.	-
Information		(Displays the current settings)	-
Reset all	Execute	Returns all items in the set-up menus to the default values. Press the [Enter] button and then select [Yes] on the confirmation screen displayed. · Execute the [Reset] function from each individual sub menu to return the image and sound settings to the default values for each menu. · The user logo, lamp time, language and BNC settings will not be returned to the default values. Perform the reset procedure after the lamp has been replaced. (see page 87)	-

- The image menu and information displayed will differ in accordance with the projected input source, and Menus other than that belonging to the projected input source cannot be adjusted.
- The information menu displays the status of the input source settings being projected.

User logo registration

Registers the images currently displayed as the user logo.

- 1 Displays the image that is to be registered as the user logo.
- 2 Press the [Menu] button and select [User's Logo] - [Execute].
The confirmation screen will be displayed.

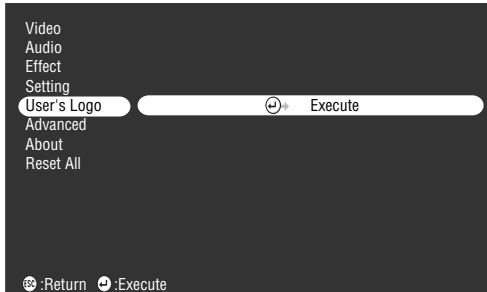

- 3 Select [Yes] and then press the [↵ (Enter)] button on the main unit (the [Enter] button on the remote control).
The image to be registered will be displayed.



- 4 Adjust the position of the image with the [Sync +/-] and [Tracking +/-] buttons on the main unit ([Enter] button on the remote control), and then press the [↵Enter] button on the main unit (the [Enter] button on the remote control).
The confirmation screen will be displayed.

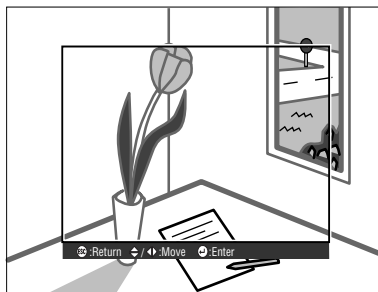

- 5** Select [Yes] and then press the [↵(Enter)] button on the main unit (the [Enter] button on the remote control).

The enlargement setup screen will be displayed.

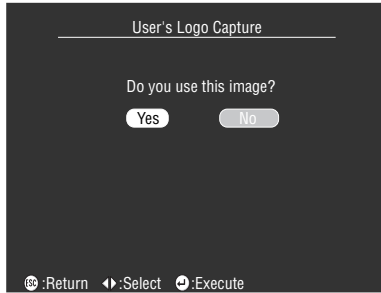

- 6** Select the enlargement rate and then press the [↵(Enter)] button on the main unit (the [Enter] button on the remote control).

The screen to confirm saving will be displayed.

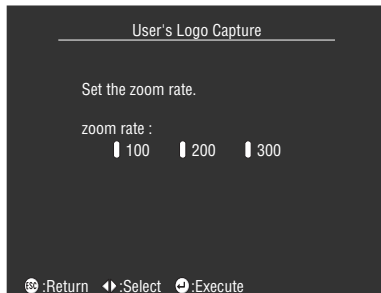

- 7** Select [Yes] and then press the [↵(Enter)] button on the main unit (the [Enter] button on the remote control).

The image will be saved. Wait until the [saving completed] screen is displayed.



Point

- A certain amount of time is required for the saving process. Do not operate the projector or connected equipment while saving is in progress. Failure to observe this may result in defects.
- The image size that can be registered is 400 x 300 dots.
- The display size will be amended depending on the input resolution.

Troubleshooting

This section provides explanations on potential problems and the methods of taking care of them.

■ Troubleshooting

When you think you have a problem, first of all check the Indicators on the projector. The projector is fitted with Operation Indicator, Lamp Indicator and Temperature Indicator to advise the projector's status.

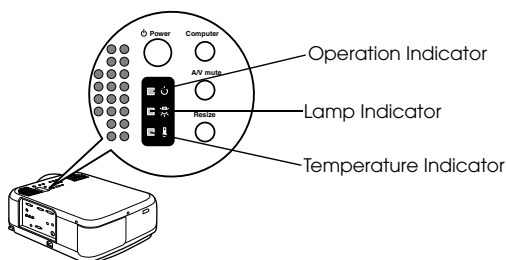

Operation Indicator

Indicator Status	Cause	Recovery or Status	Reference Page
Illuminated in Orange	Stand-by status	(Not an error) Projection will be started when the [Power] button is pressed.	42
Blinking in Orange	Cool-down procedure in progress	(Not an error) · Wait for a moment. The amount of time for the projector to cool down (cooling the lamp) will depend on the external temperature, etc. · The [Power] button cannot be used during the cool-down period. This will be illuminated in orange once the cool-down process has been completed, so press the button once more then.	49
Illuminated in Green	Projection in progress	(Not an error)	42

Indicator Status	Cause	Recovery or Status	Reference Page
Blinking in Green	Warm-up in progress	(Not an error) · Wait for a moment. · The green lamp will stop blinking and become illuminated once the warm-up procedure has been completed.	42
Illuminated in Red	Internal error	Cease operations, remove the Power Plug from the socket and contact your dealer or nearest address provided at page 97 and request repairs.	
Extinguished	The power is not switched on	The power is not switched on. · Check the power cord connection. · Check the power supply to the socket.	42

Lamp Indicator

Indicator Status	Cause	Recovery and Status	Reference Page
Blinking in Red	Lamp error	· Replace with a new lamp (ELPLP12). · If the lamp is broken, take care to avoid injury and contact your nearest address provided at page 97 Center to request repairs. · Ensure that the lamp and lamp cover have been attached firmly after replacing the lamp. The equipment is fitted with a mechanism that prevents the lamp from being switched on if the lamp and lamp cover are not securely in place.	87
Blinking in Orange	Time to replace the lamp.	Replace with a new lamp (ELPLP12).	87
Extinguished		(Not an error) The power has not been switched on or normal projection is in progress.	

Temperature Indicator

Indicator Status	Cause	Recovery and Status	Reference Page
Illuminated in Red	Excessive internal temperature (overheating)	<ul style="list-style-type: none"> · Use the projector within the permissible temperature range of between 5 degrees Celsius and 40 degrees Celsius. · Install the projector in a well-ventilated place and ensure that the ventilation inlet and outlet are not blocked. · Clean the Air Filter. 	23 85
Blinking in Red	Internal error	Cease operations, remove the Power Plug from the socket and contact your dealer or nearest address provided at page 97 and request repairs.	
Blinks in orange	High-temperature cooling in progress	<ul style="list-style-type: none"> · (This is not an error, but the projector will automatically cease operating if the temperature increases any further.) · Use the projector within the permissible temperature range of between 5 degrees Celsius and 40 degrees Celsius. · Install the projector in a well-ventilated place and ensure that the ventilation inlet and outlet are not blocked. · Clean the Air Filter. 	23 85
Extinguished		(Not an error) The power has not been switched on or normal projection is in progress.	

Point

- Refer to the section on [When the Indicators Provide No Help] on the following page if the Indicators appear normal but the projected image is defective.
- Contact your dealer if an Indicator status not covered by the above table is apparent.

■ When the Indicators provide No Help

Refer to each relevant item if the following situations arise but the indicators provide no help.

- The image is not projected page 77
- No sound page 82
- The image is unclear page 79
- The remote control will not work page 83
- The image is cut up (Large)/Small page 81
- Cannot end page 83
- The image color is bad page 81
- The image is dark page 82

The image is not projected

● Nothing is displayed



Nothing is displayed

- **Is the Lens Cover still in place?**
[see page 41](#)
- **Has the power been switched off and then on immediately?**
The [Power] button will not operate after projection has been finished (during the cooling down procedure). The [Power] button will work again after the cooling down process. Projection lamp cooling operations: the operation indicator is illuminated in orange has been completed.
[see page 49](#)
- **Is the Sleep Mode set at ON?**
When the sleep mode has been set at [ON], the lamp will be automatically extinguished if no operations occur and no signals are input for a period of thirty minutes.
[see page 70](#)
- **Did you press the [Power] button?**
[see page 42](#)
- **Has the brightness of the image been correctly adjusted?**
[see page 67](#)
- **Is the system in the [A/V Mute] mode?**
[see page 55](#)
- **Perform the reset procedure.**
[see page 71](#)
- **Is the input image completely black?**
There are cases where input images will become completely black owing to screen savers, etc.
- **Are image signals being input?**
No message will be displayed if the [Menu] - [Settings] - [No Signal Display] parameter is set at OFF. Set this to black or blue to display the message.
Refer to the relevant items when the message is displayed.
[see page 78](#)

● Messages



[Not Supported]
will be displayed

- **Is the resolution of the image signals being output from the computer higher than the displayable resolution (EMP-7600: 1600 x 1200, EMP-5600: 1440 x 1080)?**

see page 26

- **Check to ensure that the mode supports the frequency of the image signals output from the computer.**

Refer to the computer's instruction manual to discover how to amend the resolution and frequency of the image signals output from the computer.

see page 26



[No Signal]
will be displayed

- **Have the cables been connected correctly?**

see page 26, 37

- **Has the correct image input port been selected for the connection?**

Press the [Computer] or [Video] buttons on the projector ([Comp1], [Comp2/YCbCr] [Video] on the remote control) to switch the image.

see page 43

- **Has the power supply to the connected computer or video equipment been switched on?**

see page 44

- **Are image signals being output from the connected computer or video equipment?**

- **Note-type and liquid crystal type computers must output image signals to the projector.**

Image signals are not output externally simply because they are output to the LCD screen under normal conditions, so the setting must be switched to external output.

There are models for which image signals are not output to the LCD screen when output externally.

see page 26

The image is unclear

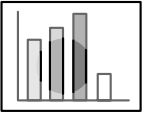

- The screen is blurred.
- Focus can only be attained in certain areas.

- **Has the focus been set correctly?**
[see page 50](#)
- **Has the projection angle been increased by adjusting the feet?**
There are cases where the vertical focus is difficult to align if the projection angle is too large.
- **Is the projection distance suitable?**
The recommended projection distance range is between 1.1m and 14.5m (EMP-7600)/1.1, and 14.6 (EMP-5600). Locate the projector within this distance range.
[see page 24](#)
- **Is the lens soiled?**
[see page 25](#)
- **Is the projection light shining at right angles onto the screen?**
[see page 85](#)
- **Is the lens fogged?**
Condensation will form on the surface of the lens when the projector is suddenly brought into a warm room from a cold room, and this may lead to the image seeming blurred. In this event, switch the power off and leave the unit to stand for a while.
- **Has the [Sync., Tracking and Position] been adjusted?**
The image can be adjusted by regulating the [Tracking] and [Sync] buttons on the projector while monitoring the image on screen. Adjustments can also be made by opening the [Menu].
[see page 51, 67](#)
- **Has the signal format setting for the image been set correctly?**
 - In the case of computer images:
Set the signal format with [Menu] – [Image] – [Resolution]. There are cases where the image signals being input cannot be determined in the [Auto] mode.
[see page 67](#)
 - In the case of video images:
Select the video signal format with [Menu] – [Advanced] – [Video Signal]. There are cases where the video image signals being input cannot be determined in the [Auto] mode.
[see page 68](#)

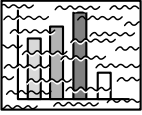

- The image is disturbed.
- Noise appears

- **Has the cable been connected correctly?**
see page 26, 37
- **Is the selected resolution correct?**
Align the computer with the signals supported by the projector. Refer to the computer's instruction manual for details on how to amend the signals.
see page 26
- **Has the [Sync., Tracking and Position] been adjusted?**
The image can be adjusted by regulating the [Tracking] and [Sync] buttons on the projector while monitoring the image on screen. Adjustments can also be made by opening the [Menu].
see page 51, 67
- **Has the cable length been extended?**
There are cases where noise will occur if the cable length is extended.
- **Has the signal format setting for the image been set correctly?**
 - In the case of computer images:
Set the signal format with [Menu] – [Image] – [Resolution]. There are cases where the image signals being input cannot be determined in the [Auto] mode.
see page 67
 - In the case of video images:
Select the video signal format with [Menu] – [Image] – [Video Signal Format]. There are cases where the video image signals being input cannot be determined in the [Auto] mode.
see page 68
- **Are the settings under [Menu] [Settings] [Computer2] correct for your system?**
 - For computer images:
Set to [RGB].
 - For video images:
For component video signals, set to either [YCbCr] or [YPbPr] depending on your input signal.
see page 38, 39
For RGB Video signals, set to [RGB].

The image is cut up (Large)/Small

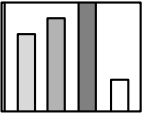

- The image is cut up
- The image is small

- **There is a possibility that the [Resize] setting has not been correctly selected.**

Press the [Resize] button.

[see page 56](#)

- **Has the [Position] been adjusted?**

Adjust with [Menu] – [Image] – [Position].

[see page 67](#)

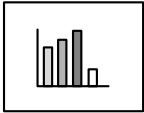

- **Is the selected resolution correct?**

Align the computer with the signals supported by the projector. Refer to the computer's instruction manual for details on how to amend the signals.

[see page 26](#)

- **Amend the resolution for note-type and liquid crystal type computers.**

Either amend the resolution so that the display fills the entire screen, or set the image signals so that only external output is possible.

[see page 26](#)

The image color is bad

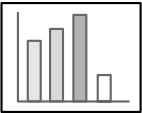

- **Has the image brightness been correctly adjusted?**

[see page 67](#)

- **Have the cables been connected correctly?**

[see page 26, 37](#)

- **Has the contrast been correctly adjusted?**

[see page 67](#)

- **Has the color setting been correctly adjusted?**

[see page 70](#)

- **Have the color density and tint been correctly adjusted?**

(The display on the computer monitor or the liquid crystal screen will not always match up with the tint of the image, but this is not an abnormality.)

[see page 67](#)

- **Is it time to replace the lamp?**

If the Lamp Indicator is blinking, it means that the time to replace the lamp is drawing near. When the time to replace the lamp draws near, the image will appear dark and the tint will deteriorate. In this event, replace the lamp with a new one.

[see page 87](#)

- **For component video signal input, are the settings under [Menu] [Settings] [Computer2] correct for your system?**

For component video signals, set to either [YCbCr] or [YPbPr] depending on your input signal.

[see page 38, 39](#)

The image is dark

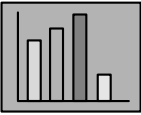

- **Is it time to replace the lamp?**
The lamp indicator blinking notifies the user that it is time to replace the lamp. When the time to replace the lamp draws near, the image will appear dark and the tint will deteriorate. In this event, replace the lamp with a new one.
[see page 87](#)
- **Has the image brightness been correctly adjusted?**
[see page 67](#)
- **Has the contrast been correctly adjusted?**
[see page 67](#)

No sound

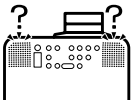

- **Has the sound input been connected correctly?**
[see page 33, 37](#)
- **Has the image for which sound is required been selected?**
[see page 43](#)
- **Is sound being emitted from connected equipment?**
Confirm the sound from connected equipment, etc.
Has the volume been turned right down?
[see page 62](#)
- **Has the volume been set to the minimum?**
[see page 62](#)
- **Has the [A/V Mute] function been left on?**
There is a possibility that the [A/V Mute] mode is in effect.
Press the [A/V Mute] button, adjust the volume, or display the menu to cancel the [A/V Mute] status.
[see page 55](#)
- **Is the sound being output to external speakers?**
Sound will not be output from the projector's speaker if a stereo mini-jack has been connected to the Audio Out port.

The remote control will not work



- Is the [R/C ON OFF] switch on the remote control on?
[see page 42](#)
- Is the remote control being aimed in the correct direction?
The operable range of the remote control unit is 30° to the left and right, and 15° up and down.
[see page 21](#)
- Is the distance between the remote control and the projector too great?
The operable distance of the remote control unit is approximately 10m.
[see page 21](#)
- Is the remote control receiver connected and the remote control being aimed at the projector?
- Is the light-receiving area on the remote control blocked?
- Has the remote control light-receiving area been subject to direct sunlight, fluorescent light or any other strong light source?
- Have the batteries been mounted in place?
[see page 21](#)
- Have the batteries run out?
- Have the batteries been mounted back to front?
[see page 21](#)

Cannot end (after the [Power] button has been pressed)

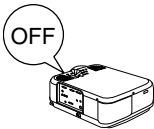

- Is the Operation Indicator illuminated in orange?
The projector has been designed so that the Operation Indicator is not extinguished even when the power has been switched off.
The Operation Indicator will be extinguished when the Power Plug has been disconnected from the socket.
- The fan will not cease operations.
The cool-down process (to allow the projector lamp to cool down; the operation indicator will blink in orange) will be performed after the power has been switch off by pressing the [Power] button. The operation indicator will be illuminated in orange when this has been completed, so remove the power plug from the socket.
*The amount of time required for the cool-down process will depend on the external temperature.

Point

If an abnormality remains after checking the results of the above inspections, disconnect the Power Plug from the socket and consult with your dealer.

Maintenance

This section provides explanations on taking care of the projector, replacing consumable items and other maintenance procedures.

■ Cleaning the Projector, Cleaning the Lens, Cleaning the Air Filter

Clean the projector if it becomes soiled or if the quality of the projected images deteriorate. Please clean the air filter about every 100 hours of operation.

Warning

- Personnel other than qualified servicemen must never open the projector. Many high-voltage parts are contained inside the cover that may cause electric shocks. Contact your dealer or your nearest address provided at page 97 to request internal inspections, repairs, adjustments, cleaning and other tasks.
- Exercise caution when handling the Power Plug and Power Connector. Mishandling may result in the outbreak of fire and electric shocks. Observe the following when handling the Power Plug.
 - Do not connect plugs or connectors that have become dirty or have foreign matter adhering to them.
 - Ensure that the plugs and connectors are firmly inserted in the relevant sockets as far as they will go.
 - Never attempt to connect plugs and connectors with wet hands.

Caution

- Never attempt to remove the lamp immediately after use. Failure to observe this may result in burns or other injuries. Turn off the projector and allow the lamp to cool down for at least 60 minutes first.
- Disconnect the Power Plug and Power Connector from their sockets when carrying out maintenance tasks. Failure to observe this may result in electric shocks.

Switch off the power supply and disconnect the Power Cord prior to cleaning any part of the projector.

Cleaning the projector

- Gently wipe the soiled parts of the projector with a soft cloth.
- When the soiling is severe, wipe the area with a cloth moistened with a medium-strength cleaning agent diluted with water, and then gently wipe it with a dry cloth.
Never use wax, Benzene, thinner or other active agents. Failure to observe this may result in damage or paint peeling from the casing.

Cleaning the lens

Clean the lens with an air-blower (available on the open market) and special lens cleaning paper. The surface of the lens is easily damaged, so exercise extreme caution and avoid using anything other than soft materials.

Cleaning the Air Filter

Air ventilation will deteriorate and the internal temperature of the projector will rise if the Air Filter becomes blocked with dirt and dust, and this may result in damage.

Ensure that the projector is stood on its end and the Air Filter cleaned with a vacuum cleaner to prevent the dirt and dust from penetrating inside.

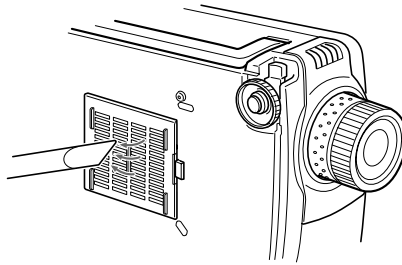

Point

- If it is no longer possible to remove the dirt from the Air Filter or it begins to crack, it is time to replace it. Contact your dealer in this event.
 - A replacement air filter is packaged with the replacement lamp. Replace the Air Filter at the same time as replacing the lamp.
-

■ Replacing the Air Filter

Replacement method

- 1** Switch off the power supply, allow the projector to cool down, and then disconnect the Power Cord. The amount of time required for the projector to cool down will depend on the surrounding temperature.
- 2** Remove the Air Filter.

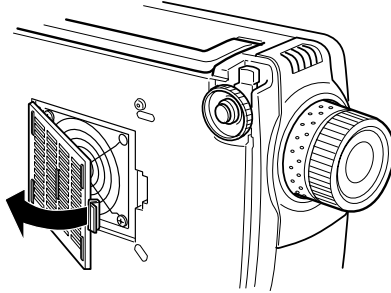

Point

Ensure that the projector is stood on its end when replacing the Air Filter to prevent the dirt and dust from penetrating inside.

- 3** Set a new Air Filter in place.

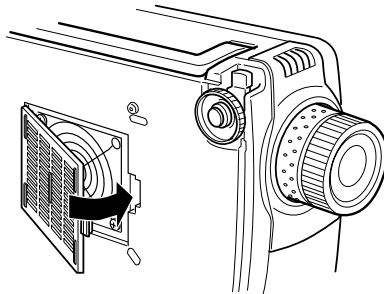

Point

- Insert the clips before pressing on the catch to set the air filter in place.
 - Dispose of used air filters in accordance with waste regulations in your community.
-

■ Replacing the Lamp

Replace the lamp at the following times (model number: ELPLP12).

When a message stating [Lamp Replace] is displayed for thirty seconds after the start of projection

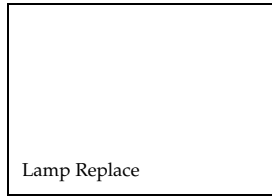

When the lamp indicator is blinking in orange

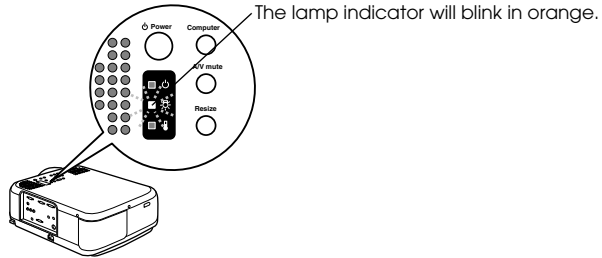

When the brightness and picture quality has deteriorated below the initial levels

Point

- Replace the lamp when it will not light up even if it is not time for replacement.
- Replace the lamp as quickly as possible after the message has been displayed to maintain the initial brightness levels and picture quality.
- The replacement message has been set at approximately 1,400 hours of use in order to maintain the initial brightness levels and picture quality. Although the replacement message is displayed after approximately 1,400 of use, there are cases where the individual characteristics of each lamp and other usage conditions result in it not lighting up before this 1,400 hours has elapsed. For this reason, always prepare a replacement lamp well in advance.
- Replacement lamps are available from Epson OA Supplies Inc. Order your lamps from freedial (0120) 251-528 or purchase them from your nearest Epson dealer.

⚠ Warning

If the lamp should break, handle the shards very carefully to avoid injury, and contact your dealer or your nearest address provided at page 97 to request repairs.

Replacement method

1 Switch off the power supply, allow the projector to cool down, and then disconnect the Power Cord.

The amount of time required for the projector to cool down will depend on the surrounding temperature.

2 Remove the lamp cover only after the lamp has cooled sufficiently.

- It will take at least 60 minutes for the lamp to cool sufficiently.
- Loosen the screw fixing the lamp cover in place with the screwdriver provided with the replacement lamp. Pull the right-hand side of the lamp cover slightly forwards to release the hook, slide it to the left and then remove the entire cover.

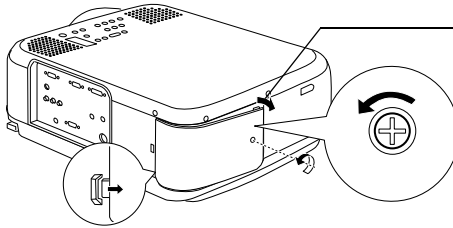

Avoid an open/close angle exceeding 15 degrees when pulling the cover forward. The use of excessive force may result in the clip on the hook bending.

3 Withdraw the lamp.

Loosen the two screws holding the lamp in place, and then pull the lamp out towards you.

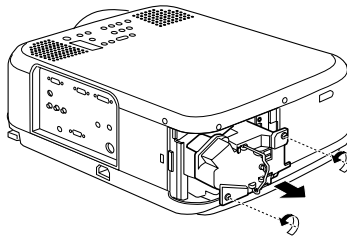

4 Attach a new lamp.

Align the direction, push the lamp in as far as it will go, and then secure it in place with the two screws.

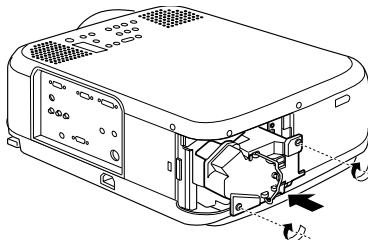

5 Attaching the lamp cover.

First attach the hook on the left side of the lamp cover, and then the right. Snap the cover into place and secure with the screw.

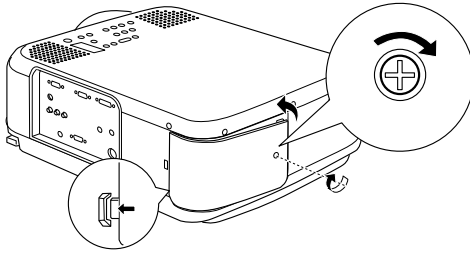

Point

- Attach the lamp and lamp cover firmly. The power will not be reinstated unless the lamp and lamp cover are set firmly in place.
- A replacement Air Filter is packaged with the replacement lamp. Replace the Air Filter at the same time as replacing the lamp.
- Ensure that the lamp illumination time is reset in accordance with the following procedure after the lamp has been replaced with a new one.

Resetting the lamp illumination time

1 Press the [Help] button for five or more consecutive seconds.

The screen for resetting the lamp's illumination time will be displayed after the help menu has been displayed.

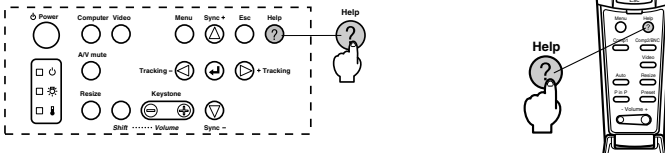

2 Select [Yes]

Press the [Tracking +, -] on the main unit (lower the [Enter] button on the remote control unit) and select [Yes].



3 Execution

Press the [↵ (Enter)] button on the main unit or the [Enter] button on the remote control unit to execute the process.

Others

This section provides explanations on optional items and after service care, as well as providing details on specifications, terminology and other technical information.

■ Optional Parts

The following optional parts are available for purchase in accordance with your needs.

MAC Adapter Set	ELPAP01	Soft Carrying Case	ELPKS10
Image Presentation Camera	ELPDC01	Hard Travel Case	ELPKS25
Image Presentation Camera (XGA)	ELPDC02	Wide Attachment Lens	ELPAW01
Image Presentation Camera (Video)	ELPDC03	Long Throw Attachment Lens	ELPAL01
Computer Cable	ELPKC02	Ceiling Plate	ELPFC01
VGA-HD15 PC Cable (3.0m)	ELPKC09	Ceiling Plate (silver)	ELPFC03
VGA-HD15 Extension Computer Cable (20m)	ELPKC10	Pipe (370mm)	ELPFP01
VGA-HD15/BNC PC Cable (1.8m)	ELPKC11	Pipe (570mm)	ELPFP02
VGA-13W3/BNC WS Cable (3.0m)	ELPKC12	Pipe (770mm)	ELPFP03
VGA-BNC/BNC WS Cable (3.0m)	ELPKC13	Pipe (370mm) (silver)	ELPFP04
VGA-EVC WS Cable (3.0m)	ELPKC14	Pipe (570mm) (silver)	ELPFP05
VGA-EVC/BNC WS Cable (3.0m)	ELPKC15	Pipe (770mm) (silver)	ELPFP06
Serial Mouse Cable	ELPKC18	Portable Screen (50")	ELPSC06
Computer Video Cable	ELPKC19	60" Screen	ELPSC07
Digital I/F Cable (DVI-D/DVI-D 3.0m)	ELPKC20	80" Screen	ELPSC08
Digital I/F Cable (DVI-D/DFP 3.0m)	ELPKC21	Remote Control Receiver	ELPST02
HDTV Cable HD15/D port (3.0m)	ELPKC22	Remote Control Receiver kit	ELPST04
HDTV Cable 3BNC/D port (3.0m)	ELPKC23	Link Set	ELPSW06
Mouse Cable Set	ELPKC24	Spare Lamp	ELPLP12

■ Transportation

The projector contains many glass and precision parts. Ensure that the following precautions are observed to prevent the projector from being damaged by impact during transportation.

● When sending the projector to the manufacturer for repairs, etc.

- Use the box in which the projector was packed at the time of purchase.
- If the box is no longer available, protect the projector by wrapping it in shock-proof material to prevent impact, and then place it in a strong cardboard box for transportation purposes.

● When transporting repeatedly

- Place the projector in the optional Hard Travel Case (ELPKS25) and clearly mark that it is a precision instrument for the delivery people, and then request transportation.
- It is recommended that the [Handle With Care] stickers are attached to the Hard Travel Case during transportation.

● When carrying by hand

- Use the optional Hard Travel Case (ELPKS25).
- Carry the projector onto airplanes as cabin baggage.

* Note that the warranty does not cover any damage to the equipment caused by the user when transporting the projector.

■ Terminology

This section provides simple explanations for the terminology used within the manual, items for which explanations are not available, and other complex processes.

A/V Mute	Temporarily erases the image and sound at the same time. The sound and image can be muted by pressing the [A/V Mute] button on the projector. Press the [A/V Mute] button once again or adjust the volume or display the menu to cancel the mute mode.
DVI-D port	The input port that conforms to the DVI digital video ratings (Digital Visual Interface: Ratings to govern how video signals are digitally transmitted). Synchronization and tracking misalignments will not occur during transmission.
D output port	The output port for digital tuners that support the new digital broadcasts within Japan.
Remote port	Cannot be used with this projector.
SVGA	IBM PC/AT compatible (DOS/V equipment) signals with 800 horizontal pixels and 600 vertical pixels.
SXGA	IBM PC/AT compatible (DOS/V equipment) signals with 1,280 horizontal pixels and 1,024 vertical pixels.
Sync(synchronization)	Outputs computer signals at a pre-determined frequency. The image will not be projected clearly unless this frequency is aligned with the frequency of the projector. Aligning the signal phasing is known as synchronization. Projected images will be subject to disturbance, blurring and horizontal noise if not synchronized.
VGA	IBM PC/AT compatible (DOS/V equipment) signals with 640 horizontal pixels and 480 vertical pixels.
XGA	IBM PC/AT compatible (DOS/V equipment) signals with 1,024 horizontal pixels and 768 vertical pixels.
USB	An abbreviation for Universal Serial Bus. This is an interface for connecting comparatively low frequency equipment to the computer.
UXGA	IBM PC/AT compatible (DOS/V equipment) signals with 1,600 horizontal pixels and 1,200 vertical pixels.
Color temperature	The temperature of the subject that emits light. A blue hue is attained when the color temperature is high, and a red hue is attained when the color temperature is low.
Color differential signal	Video equipment transmits signals through three cables as Red-Bright (R-Y), Bright (Y) and Blue-Bright (B-Y). This enables the composite signals (the red, green and blue signals and their brightness signals are transmitted along one cable) to be projected more clearly.
Operating system	The software necessary to operate the computer.
Cool-down	A lamp cooling procedure continues to operate even after the power supply has been switched off and the lamp extinguished. The cooling fan will begin to operate when the lamp is extinguished, and button operations will not longer be possible. This period is known as the cooling down period. The amount of time required for the cooling down procedure will differ in accordance with the surrounding temperature.

Contrast	By strengthening or weakening the tone of the colors, it is possible to project characters and pictures more clearly and attain a softer tint. This is known as contrast adjustment.
Stack projection	Refers to the simultaneous duplicate projection of images with the use of multiple projectors in order to increase projection image brightness.
Theft-protection lock	A theft-proof cable (available on the open market) is passed through the holes on the projector case to secure it to a desk or column. These holes support the Micro-Saver Security System manufactured by Kensington Inc.
Tracking	Outputs computer signals at a pre-determined frequency. The image will not be projected clearly unless this frequency is aligned with the frequency of the projector. Aligning the signal frequency is known as tracking. Projected images will be subject to disturbance, blurring and horizontal noise if not synchronized.

■ Specifications

Product Name	Multi-Media Projector	
Model	EMP-7600/EMP-5600	
External Dimensions	Width 277 × Height 143 × Depth 361 mm(excluding the lens and feet)	
Panel Size	1.3-inch (Width 27mm × Height 20mm × Corner-to-corner 34 mm)	
Display Emthod	Poly-silicone TFT	
Drive Method	Full-line 12-phase block sequential writing	
Pixel Count	EMP-7600: 786,432 (Horizontal 1,024 × Vertical 768 pixels × 3) EMP-5600: 480,000 (Horizontal 800 × Vertical 600 pixels × 3)	
Focus Adjustment	Manual	
Zoom Adjustment	Manual (approximately 1:1.3)	
Lamp (light source)	UHE lamp model: ELPLP12 rated 200W	
Maximum Sound Output	3W × 3W stereo	
Speakers	2	
Power Supply	AC100-240V 50/60Hz approximately 285W, 9W during power-saving	
Temperature range during use	+5 to +40(with no condensation)	
Temperature range during storage	-10 to +60(with no condensation)	
Weight	Approximately 6.8kg	
Connection ports	Computer #1 port	Single-system mini D-Sub 15pin(female)/ DVI-D port (switch)
	Computer2/Component Video port	Single-system mini D-Sub 15pin(female)
	Audio1 port	Single-system Stereo mini-jack
	L-Audio2-R port (for video use)	Single-system RCA pin jack × (L, R)
	Mouse port	1-system DIN 10pin
	Video port	Single-sysem RCA pin jack
	S-Video port	Single-system mini DIN 4pin
	Remote port	Single-system Stereo mini-jack
	Audio Out port	1-system stereo mini jack
Control port	1-system RS-232C	

Check Sheet

Kindly take a copy of the check sheet and fill out the relevant items before contacting us in order to provide us with details on the systems of the trouble that has occurred with your projector.

Images

Inquiry details

- The power supply cannot be switched on
- Nothing is displayed on the screen
- A message is displayed
 - NO SIGNAL
 - The image signals are not being input
 - The projector is not able to receive the signals
- Blue screen (blue back)
- Projection pattern
- Logo (the message is not displayed)

- The image breaks up or is too small
 - An area on which nothing is displayed exists
 - The image is smaller than the screen
 - The screen is distorted into a trapezoid shape
 - Certain dots are missing

- The image is not clear
 - The image is blurred or cannot be focused.
 - Stripes are displayed
 - Flickering
 - Certain characters are missing

- The color or the image is bad or too dark
 - Dark
 - The color is bad or dark (computer)
 - The color is bad or dark (video)
 - The color is different on a TV and CRT

Menu

- The menu is displayed
 - Setup Sleep Mode ON
 - Information (computer)
 - Lamp ON Time H
 - Frequency H Hz
 - SYNC polarity H Positive Negative
 - V Positive Negative
 - SYNC mode Separate Composite
 - Sync on Green
 - Input resolution X
 - Refresh sheet Hz
 - Information (video)
 - Lamp ON Time H
 - Video signal system AUTO
 - NTSC
 - Others

Describe the problem

EMP
Serial number

Purchasing time
Year, month

Indicator
(Describe the color of the indicator lamps and the status of illumination and blinking)

Operation

Lamp

Temperature

Connector
 Is it plugged in firmly?

Computer

- Computer1(D-Sub15 pin)
- Computer2
- DVI-D

Video

- Composite
- S port
- Component

Computer settings (screen property)

LCD display exists

Resolution X

Refresh sheet Hz

Connector
 Is it plugged in firmly?

Computer
Win • MAC • EWS
Manufacturer's name()
Model ()
Note, desktop, single unit
Panel resolution(X)
Video board ()

Power cable
 Is it plugged in firmly?
 Power switch on

Video equipment
Video, DVD, camera
Manufacturer's name
()
Model()

Computer cable
 Specially designed

Length m
Model number()

Wiring, additional equipment
Model number()

Switching unit
Model number()

Always occurs when _____ is performed, etc.

Time of occurrence Before use. Immediately after the start of usage. During usage. Other.()

Frequency of occurrence Always. Sometimes (___ times per ___ usage). Other.()

● Sound

Inquiry details

- No sound can be heard
- The volume is too low
- The sound breaks up
- A different sound is emitted

Menu

- The menu is displayed
- Sound
 - Volume()

EMP
Serial number
Purchasing time
Year, month

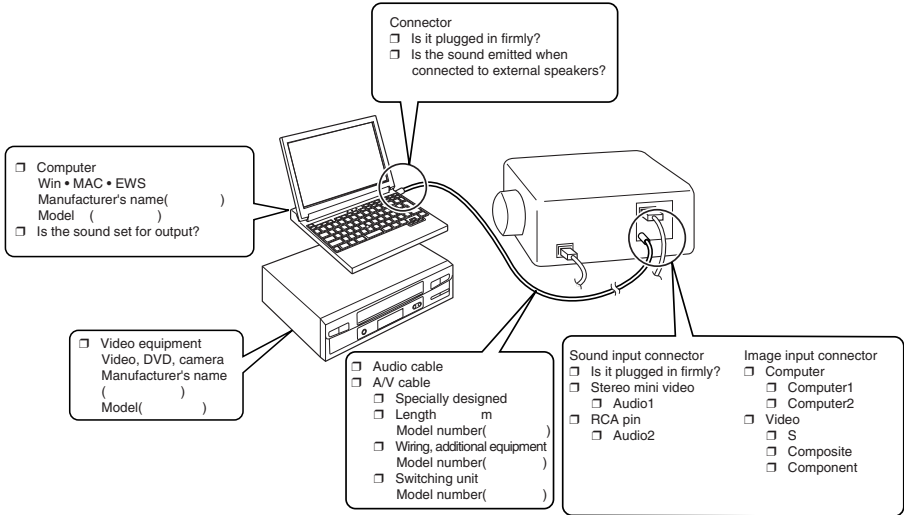

Always occurs when _____ is performed, etc.

Time of occurrence Before use. Immediately after the start of usage. During usage. Other.()

Frequency of occurrence Always. Sometimes (___ times per ___ usage). Other.()

■ World-Wide Warranty Terms

This product includes a world-wide warranty, which allows the equipment to be repaired in more than forty-five countries of the world. Note that product is not covered by the terms of warranty stated here, but by the terms of warranty laid out on the warranty card supplied when the equipment is purchased in each relevant country.

The world-wide warranty for the Epson Multi-Media Projector is valid in the following countries:

<Europe>

·Austria ·Belgium ·Bulgaria ·Croatia ·Cyprus ·Czech
·Denmark ·Finland ·France ·Germany ·Greece ·Hungary
·Ireland ·Italy ·Luxemburg ·Macedonia ·Holland
·Norway ·Portugal ·Poland ·Romania ·Slovakia ·Slovenia
·Spain ·Sweden ·Switzerland ·Turkey ·United Kingdom ·Yugoslavia

<North America and Central America>

·Canada ·Costa Rica ·Mexico ·United States of America

<South America>

·Argentina ·Brazil ·Chile ·Colombia ·Peru ·Venezuela

<Asia and Oceania>

·Australia ·Hong Kong ·Japan ·South Korea ·Malaysia ·Singapore ·Taiwan ·Thailand

The warranty is subject to the following terms and conditions.

- 1)The warranty is only valid when the product is presented together with the warranty card or receipt of purchase issued in the country of purchase.
- 2)The warranty will be implemented based on the warranty terms and conditions established by Epson or a service organization stipulated by Epson in countries listed in the instruction manual.
 - The period of warranty is twelve months from the date of purchase.
 - The warranty will cover the cost of spare parts and labor in accordance with the conditions laid out by Epson within the applicable range of the warranty.
 - The user will not be supplied with a substitute product during the period of repair as a basic policy.
- 3)The warranty will not apply in the following situations.
 - a.Defects in consumables (lamps) or optional parts.
 - b.When the product is damaged owing to inappropriate use, damaged during transportation, or handled in a manner not stipulated by the instruction manual.
 - c.When repairs or modified work have been carried out by a third party other than Epson or a service organization stipulated by Epson.
 - d.When trouble arises through the use of optional parts or consumable parts not manufactured by Epson or not otherwise authorized for use by Epson.

Note:

The power cable supplied with the product is subject to the power supply conditions of the country of purchase. When using the product overseas, ensure that an Epson cable specifically manufactured for use in that relevant country is purchased.

List of contacts for the Epson Multi-Media Projector's world-wide warranty

This list of contacts is current as of December 1st, 2000. Access the relevant home pages for up-to-date information. If no home page is available, access the main web site at www.epson.com.

<EUROPE>

AUSTRIA :

**EPSON Support Center
Austria**

Tech. Help Desk: 00491805 235470
Web Address:
<http://www.epson.at>

BELGIUM :

**EPSON Support Center
BeNeLux**

Tech. Help Desk: 032 70222082
Web Address:
<http://www.epson.be>

BULGARIA :

PROSOFT

6. AI Jendov Str.
BG-1113 Sofia
Tel: 00359.2.730.231
Fax: 00359.2.9711049
E-mail: Prosoft@internet-BG.BG

CROATIA :

Recro d.d.

Trg. Sportova 11
HR-10000 Zagreb
Tel: 00385.1.6350.777
Fax: 00385.1.6350.716
E-mail: recro@recro.hr
Web Address:
<http://www.recro.hr>

CYPRUS :

CTC- INFOCOM

6a. Ionos Str., Engomi
P. O. Box 1744
2406 Nicosia, Cyprus
Tel: 00357.2.458477
Fax: 00357.2.668490

CZECH :

EPRINT s.r.o.

Stresovicka 49
CZ-16200 Praha 6
Tel: 00420.2.20180610
Fax: 00420.2.20180611
E-mail: eprint@mbox.vol.cz

FINLAND :

Tech. Help Desk: 0800.523010
(note. Some geographical
areas excluded)

FRANCE :

EPSON France,

68 bis rue Marjolin, F-92300
Levallois,
Tech. Help Desk: 01.49.61.33.95
Web Address:
<http://www.epson.fr>

GERMANY :

**EPSON Deutschland
GmbH**

Zülpicher Straße 6
D-40549 Düsseldorf
Tech. Help Desk: 01805 235470
Web Address:
<http://www.epson.de>

GREECE :

Pouliadis Ass. Corp.

Aristotelous St. 3
GR-19674 Athens
Tel: 0030.1.9242072
Fax: 0030.1.9441066

HUNGARY :

R.A. Trade Kft.

Petőfi Sandor u. 64
H-2040 Budaör
Tel: 0036.23.415.317
Fax: 0036.23.417.310

IRELAND :

Tech. Help Desk: 01.6799016

LUXEMBURG :

**EPSON Support Center
BeNeLux**

Tech. Help Desk:
0032 70 222082
Web Address:
<http://www.epson.be>

MACEDONIA :

Rema Kompjuteri d.o.o.

St. Naroden Front 19a
lok 16
91000 Skopje/ Macedonia
Tel: 00389.91.118159
Fax: 00389.91.118159

NETHERLANDS :

**EPSON Support Center
BeNeLux**

Tech. Help Desk: 043 3515752
Web Address:
<http://www.epson.nl>

NORWAY :

Tech. Help Desk: 800.11828

POLAND :

FOR EVER Sp. z.o.o.

Ul. Frankiska Kawy 44
PL- 01-496 Warszawa
Tel: 0048.22.638.9782
Fax: 0048.22.638.9786
E-mail: office@for-ever.com.pl

PORTUGAL :

EPSON Portugal, S.A.

Rua do Progresso, 471-1
Perafita- Apartado 5132
Tech. Help Desk: 0808 200015
Web Address:
<http://www.epson.pt>

ROMANIA :

MB Distribution S.R. L.

162, Barbu Vacarescu Blvd.
Sector 2
RO- 71422 Bucharest
Tel: 0040.1.2300314
Fax: 0040.1.2300313
E-mail: office@mbd-epson.ro

DENMARK :

Tech. Help Desk: 80881127

SLOVENIA :**Repro Ljubljana d.o.o.**

Smartinska 106
SLO-1001 Ljubljana
Tel: 00386.61.1853411
Fax: 00386.61.1400126

SPAIN :**EPSON IBERICA, S.A.**

Avda. Roma 18-26,
08290 Cerdanyola del Vallès,
Barcelona, SPAIN
Centro At. al Cliente: 902.404142
E-mail: soporte@epson.es
Web Address:
<http://www.epson.es>

SWEDEN :

Tech. Help Desk: 08 445 1258

<NORTH, CENTRAL AMERICA & CARIBBEAN ISLANDS>**CANADA :****Epson Canada, Ltd.**

100 Mural Street, Suite 300
Richmond Hill, Ontario
CANADA L4B 1J3
Tel: 905-709-3839
Web Address:
<http://www.epson.com>

COSTA RICA :**Epson Costa Rica, S.A.**

Embajada Americana,
200 Sur y 300 Oeste
San Jose, Costa Rica
Tel: (50 6) 296-6222
Web Address:
<http://www.epsoncr.com>

ITALY :**EPSON Italia s.p.a.**

Assistenza e Servizio Clienti
Viale F. Lli Casiragi, 427
20099 Sesto
San Giovanni (MI)
Tech. Help Desk: 02.29400341
Web Address:
<http://www.epson.it>

SWITZERLAND :**EXCOM Service AG**

Moosacher Str. 6
CH-8820 Wädenswil
Tel: 01.7822111
Fax: 01.7822349
Web Address:
<http://www.excom.ch>

TURKEY :**Romar Pazarlama Sanayi**

ve TIC. A.S.
Rihtim Cad. No. 201
Tahir Han
TR-Karaköy-Istanbul
Tel: 0090.212.2520809
Fax: 0090.212.2580804

SLOVAKIA :**Print Trade spol. s.r.o.**

Cajkovskeho 8
SK-98401 Lucenec
Tel: 00421.863.4331517
Fax: 00421.863.4325656
E-mail: Pntrtd@lc.psg.SK
Web Address:
<http://www.pntrtrade.sk>

UNITED KINGDOM :**EPSON (UK) Ltd.**

Campus 100, Maylands Avenue
Hemel Hempstead,
Herts, HP2 7TJ
Tech. Help Desk: 0990 133640
Web Address:
<http://www.epson.uk>

YUGOSLAVIA :**BS Procesor d.o.o.**

Hadzi Nikole Zivkovicica 2
11000 Beograd
Tel: 00381.11.639610
Fax: 00381.11.639610

U. S. A. :**Epson America, Inc.**

3840 Kilroy Airport Way
Long Beach, CA90806
Tel: (562) 276-4394
Web Address:
<http://www.epson.com>

<SOUTH AMERICA>

ARGENTINA :

Epson Argentina S.A.
Avenida Belgrano 964/970
(1192), Buenos Aires
Tel: (54 11) 4346-0300
Web Address:
<http://www.epson.com.ar>

BRAZIL :

Epson Do Brasil Ltda.
Av. Tucunare, 720
Tambore Barueri,
Sao Paulo, SP 06460-020
Tel: (55 11) 7295-1757
Web Address:
<http://www.epson.com.br>

<ASIA & OCEANIA>

AUSTRALIA :

**EPSON AUSTRALIA PTY
LIMITED**
70 Gibbes Street Chatswood
NSW 2067 AUSTRALIA
Tel: 1300 361 054
Web Address:
<http://www.epson.com.au>

HONGKONG :

**EPSON Technical Support
Centre (Information
Centre)**
Rooms 4706-4710,
China Resources Building,
26 Harbour Road, Wan Chai,
HONG KONG
Tech. Hot Line: (852) 2585 4399
Fax: (852) 2827 4383
Web Address:
<http://www.epson.com.hk>

JAPAN :

**SEIKO EPSON
CORPORATION
SHIMAUCHI PLANT**
VD Customer Support Group:
4897 Shimauchi, Matsumoto-shi,
Nagano-ken, 390-8640 JAPAN
Tel: 0263-48-5438
Fax: 0263-48-5680
<http://www.i-love-epson.co.jp>

CHILE :

Epson Chile S.A.
La Concepcion 322
Providencia, Santiago
Tel: (562) 236-2543
Web Address:
<http://www.epson.cl>

COLOMBIA :

Epson Colombia Ltda.
Diagonal 109, 15-49
Bogota, Colombia
Tel: (57 1) 523-5000
Web Address:
<http://www.epson.com.co>

KOREA :

EPSON KOREA CO., LTD
17F HANSOL Bldg., 736-1,
Yaoksam-dong Kangnam-gu,
Seoul, 135-080, KOREA
Tel: 2-553-3515
Fax: 2-5584271
<http://www.epson.co.kr>

MALAYSIA :

**EPSON TRADING
(MALAYSIA) SDN. BHD.**
No. 21 Jalan U 1/19, Seksyen
U1,
Hicom-grenmarie Industrial
Park, 40150 Shan Alam,
Selangor Darul Ehsan
Tel: 03-5191366
Fax: 03-5191386

SINGAPORE :

**EPSON SINGAPORE
PTE. LTD.**
401 Commonwealth Drive
#01-01 Haw Par Technocentre
SINGAPORE 149598
Tel: 4722822
Fax: 4726408

PERU :

Epson Peru S.A.
Av. Del Parque Sur #400
San Isidro, Lima, Peru
Tel: (51 1) 224-2336
Web Address:
<http://www.epson.com>

VENEZUELA :

Epson Venezuela S.A.
Calle 4 con Calle 11-1
La Urbina Sur
Caracas, Venezuela
Tel: (58 2) 241-0433
Web Address:
<http://www.epson.com.ve>

TAIWAN :

**EPSON Taiwan Technology
& Trading Ltd.**
10F, No.287, Nanking East Road,
Section 3, Taipei, Taiwan, China
Tel: 02-2717-7360 ext. 327
Fax: 02-2713-2155
<http://www.epson.com.tw>

THAILAND :

**EPSON (Thailand) Co.,
Ltd.**
24th Floor, Empire Tower,
195 South Sathorn Road,
Yannawa,
Sathorn, Bangkok 10120,
Thailand
Tel: 6700680 Ext. 309,316,317
Fax: 6700688
<http://www.epson.co.th>

EPSON Technical Center

21st Floor, Payathai Tower,
128/227 Payathai Road,
Rachataewee,
Bangkok 10400, Thailand
Tel: 6120291~3
Fax: 2165005
<http://www.epson-tech.in.th>

Index

Numerics

13w3 30
5BNC 30

A

A/V Mute 69
A/V Mute button 16, 18
A/V Mute Function 55
Adjusting the Projection Position 47
Adjusting the projection size 48
adjustment values 51
Advance settings menu 64
Advanced 70, 71
Air Filter (suction inlet) 15
All reset menu 64
Audio Cable 33
Audio1 Port 16
Auto adjustment 50
Auto button 19

B

Bar 60, 69
Bass 68
Battery Cover 20, 22
Box 58, 68
Brightness 67

C

Canceling effects 60
Ceiling 71
ceiling suspended projector 23
Change-over Switch 16
Check Sheet 95
Cleaning the Air Filter 85
Cleaning the Projector, Cleaning the Lens,
Cleaning the Air Filter 84
Color 67
color differential 38
Color Setting 70
color temperature 70
Commencing projection 42

Comp1 button 43
Comp2/ YCbCr button 43
component 38
composite image signals 37
Computer 43
Computer #1 mini D-Sub 15 Port 16, 29
Computer #2 BNC Port 17
Computer #2 port 31
Computer 1-DVI-D Port 16
Computer button 15
Connecting the projector to a computer 26
Connecting up the mouse (wireless
mouse function) 35
Connecting video equipment 37
Connections of two computers 31
Contrast 67
Control Port 17
cool-down 45, 74
Cursor 58
Cursor Speed 69
Cursor/Stamp 68

D

D port 40
digital tuner's 39

E

Effect button 18, 68, 69
Effect Function 58
Effect menu 64
Eligible computers 26
Ending 45
Ending images 57
Enlarging Images (zoom function) 57
Enter button 16, 18
ESC button 15, 19
Execute 70, 71
E-Zoom button 18
E-Zoom function 57

F

Feet adjustments 47
Focus 50
Focus Ring 13, 50
Foot Adjust Lever 13, 47

Freeze button 18
Freeze Function 55
frequency 26
Front Foot 13, 15, 46, 47
Functions 52

G

Gamma 67

H

half-transparent 24
Handle 13
Help button 15
Help Function 53

I

Image menu 63
image signals 38
Indicator 18
Information 71
Information menu 64
Installation Procedure 23

K

Keystone 69
Keystone adjustment 49
Keystone button 16

L

Lamp Indicator 13, 75
Language 70
L-Audio2-R Port 17
L-Audio2-R ports 37
Left click 36
Lens Cover 41
lens cover 46
Light button 18

M

Maximum Sound Output 94
Menu button 15, 65
Menu Configuration 63

Menu Operations 65
mini D-Sub 15 pin 29
Mouse 1/2 Port 16

N

No Signal Msg 69

O

Operable distance 21
Operable range 21
Operation Indicator 13, 42, 74
Operation Panel 13, 15
overheating 76

P

P in P button 19, 69
Parts, Names and Operations 13
permissible temperature range 12
Picture in Picture Function 61
Picture Quality Adjustment 50
Position 67
Power button 15, 18, 42
Power Cord 41
Power Inlet 41
Preset 67
Preset button 19, 51
Projection 41
Projection angles 25
Projection cutting 55
projection distance 24
Projectors Mouse port 35
Prompt 69

R

R/C ON OFF switch 18, 42, 46
Rear Foot 15
Rear Proj. 71
Remote Control 18, 21
Remote control light-receiving area 18
Remote Control Receiver 13, 14
Remote Port 17
Replacing the Air Filter 86
Replacing the Lamp 87
Reset 68, 69, 70, 71

- Reset all 71
- Resize button 16, 19
- Resolution 67
- resolution 26
- RGB image signals 40
- Right click 36

S

- S image signals 37
- Safety Precautions 8
- Screen size 24
- Setting 69, 70
- Setup menu 64
- setup menu 63
- Sharpness 67
- Shift button 16
- Sleep Mode 70, 77
- Sound 68
- Sound connection 33
- Sound menu 64
- Speaker 13
- Specifications 94
- Spotlight 59, 68
- Stamp 58
- Startup Screen 70
- sub menus 63
- S-Video Port 17, 37
- Symbol displays 7
- Sync button 15
- Sync. 67
- Synchronization 51

T

- Temperature Indicator 13, 76
- temperature range 12
- Temperature range during storage 94
- Temperature range during use 94
- Terminology 92
- Tint 67
- top menus 63
- Tracking 51, 67
- Tracking button 16
- Transportation 91
- Treble 68
- Troubleshooting 74

U

- User's Logo 70
- User's Logo menu 64
- Using this manual 7

V

- Ventilation Outlet 13
- Video 43, 67, 68
- Video button 15, 19
- Video Port 17, 37
- Video Signal 68
- Volume 62, 68
- Volume Adjustment 62
- Volume button 19

W

- window display 56
- Window resizing 56
- World-Wide Warranty Terms 97

Z

- Zoom 48
- Zoom Ring 13

DECLARATION of CONFORMITY

according to ISO/IEC Guide 22 and EN 45014

Manufacturer : SEIKO EPSON CORPORATION
Address : 3-5, Owa 3-chome, Suwa-shi,
Nagano-ken 392-8502 Japan
Representative : EPSON EUROPE B. V.
Address : Entrada 701, 1096 EJ AMSTERDAM,
The Netherlands

Declares that the Product

Kind of Equipment : LCD Projector

Model : ELP-7600/5600 / EMP-7600/5600

Conforms to the following Directives and Norm(s)

Directive 89/336/EEC

: EN 55022

: EN 55024

: EN61000-3-2

: EN61000-3-3

Directive 73/23/EEC

: EN 60950

DECLARATION of CONFORMITY

According to 47CFR, Part 2 and 15 for

**Class B Personal Computers and Peripherals; and/or
CPU Boards and Power Supplies used with Class B
Personal Computers**

We : EPSON AMERICA, INC.
Located at : MS: 3-13
3840 Kilroy Airport Way
Long Beach, CA 90806-2469
Telephone: (562) 290- 5254

Declare under sole responsibility that the product identified herein, complies with 47CFR Part 2 and 15 of the FCC rules as a Class B digital device. Each product marketed, is identical to the representative unit tested and found to be compliant with the standards. Records maintained continue to reflect the equipment being produced can be expected to be within the variation accepted, due to quantity production and testing on a statistical basis as required by 47CFR 2.909. Operation is subject to the following two conditions : (1) this device may not cause harmful interference, and (2) this device must accept any interference received, including interference that may cause undesired operation.

Trade Name : EPSON
Type of Product : LCD Projector
Model : EMP-7600/5600 / ELP-7600/5600

FCC Compliance Statement For United States Users

This equipment has been tested and found to comply with the limits for a Class B digital device, pursuant to Part 15 of the FCC Rules. These limits are designed to provide reasonable protection against harmful interference in a residential installation. This equipment generates, uses, and can radiate radio frequency energy and, if not installed and used in accordance with the instructions, may cause harmful interference to radio or television reception. However, there is no guarantee that interference will not occur in a particular installation. If this equipment does cause interference to radio and television reception, which can be determined by turning the equipment off and on, the user is encouraged to try to correct the interference by one or more of the following measures.

- Reorient or relocate the receiving antenna.
- Increase the separation between the equipment and receiver.
- Connect the equipment into an outlet on a circuit different from that to which the receiver is connected.
- Consult the dealer or an experienced radio/TV technician for help.

WARNING

The connection of a non-shielded equipment interface cable to this equipment will invalidate the FCC Certification or Declaration of this device and may cause interference levels which exceed the limits established by the FCC for this equipment. It is the responsibility of the user to obtain and use a shielded equipment interface cable with this device. If this equipment has more than one interface connector, do not leave cables connected to unused interfaces. Changes or modifications not expressly approved by the manufacturer could void the user's authority to operate the equipment.

For Canadian Users

This digital apparatus does not exceed the Class B limits for radio noise emissions from digital apparatus as set out in the radio interference regulations of the Canadian Department of Communications.

Le présent appareil numérique n'émet pas de bruits radioélectriques dépassant les limites applicables aux appareils numériques de Classe B prescrites dans le règlement sur le brouillage radioélectrique édicté par le Ministère des Communications du Canada.

All rights reserved. No part of this publication may be reproduced, stored in a retrieval system, or transmitted in any form or by any means, electronic, mechanical, photocopying, recording, or otherwise, without the prior written permission of SEIKO EPSON CORPORATION. No patent liability is assumed with respect to the use of the information contained herein. Neither is any liability assumed for damages resulting from the use of the information contained herein.

Neither SEIKO EPSON CORPORATION nor its affiliates shall be liable to the purchaser of this product or third parties for damages, losses, costs, or expenses incurred by purchaser or third parties as a result of: accident, misuse, or abuse of this product or unauthorized modifications, repairs, or alterations to this product, or (excluding the U.S.) failure to strictly comply with SEIKO EPSON CORPORATION's operating and maintenance instructions.

SEIKO EPSON CORPORATION shall not be liable against any damages or problems arising from the use of any options or any consumable products other than those designated as Original EPSON Products or EPSON Approved Products by SEIKO EPSON CORPORATION.

EPSON is a registered trademark and PowerLite is a trademark of SEIKO EPSON CORPORATION.

General Notice: The following trademarks and registered trademarks are the property of their respective owners and are used in this publication for identification purposes only.

- EPSON/Seiko Epson Corp.
- Macintosh, PowerBook/Apple Computer Corp.
- IBM/International Business Machines, Inc.
- Windows/Microsoft Corp.

Other product names used herein are also for identification purposes only and may be trademarks of their respective owners. EPSON disclaims any and all rights in those marks.

EPSON®